

# High-Speed Counter I/O Module

## High-Speed Counter I/O Module

T1H-CTRIO \$488.00



## CTRIO features

The CTRIO modules offer the following I/O features:

- Eight DC sink/source inputs, 9–30 VDC
- Four isolated sink/source DC outputs, 5–30 VDC, 1A per point

### Inputs supported:

- Two quadrature encoder counters up to 100 kHz, or four single-channel counters up to 100 kHz using module terminals Ch1A, Ch1B, Ch2A and Ch2B
- High-speed edge timers, dual edge timers, pulse catch, count reset, count inhibit, or count capture or home search limits using module terminals Ch1C, Ch1D, Ch2C or Ch2D

### Outputs supported:

- Four independently configurable high-speed discrete outputs or two channels pulse output control (20Hz–25kHz per channel)
- Pulse and direction or cw/ccw pulses supported for pulse output control
- Raw control of discrete output directly from user control program

### Configure I/O screen

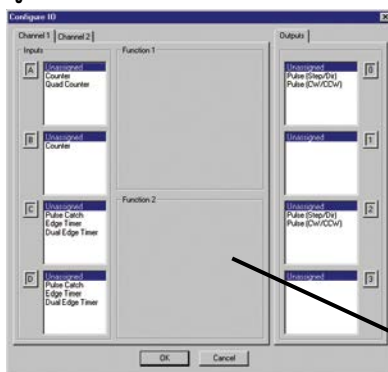

## Overview

The High-Speed Counter I/O (CTRIO) module is designed to accept high-speed pulse-type input signals for counting or timing applications and to provide high-speed pulse-type output signals for stepper motor control, monitoring, alarm or other discrete control functions. The CTRIO module offers great flexibility for applications that call for precise counting or timing, based on an input event or for

high-speed control output applications.

The CTRIO module has its own microprocessor and operates asynchronously with respect to the PLC/controller. This means that the on-board outputs respond in real time to incoming signals, so there is no delay waiting for the PLC/Controller to scan I/O.

The T1H-CTRIO module is designed to work with incremental encoders or other field devices that send pulse outputs.

## Software configuration

All scaling and configuration is done via CTRIO Workbench, a Windows software utility program. This eliminates the need for PLC ladder programming or other interface device programming to set up the module. CTRIO Workbench runs under Windows 98/2000/XP and NT 4.0 SP5 or later.

## Typical applications

- High-speed cut-to-length operations using encoder input
- Pick-and-place or indexing functions controlling a stepper drive
- Dynamic registration for web material control
- Accurate frequency counting for speed control with onboard scaling
- PLS (Programmable Limit Switch) functions for high-speed packaging, gluing, or labeling
- Sub 10 µsec pulse-catch capability for high-speed product detection
- Functions for level or flow

### CTRIO Workbench main configuration screen

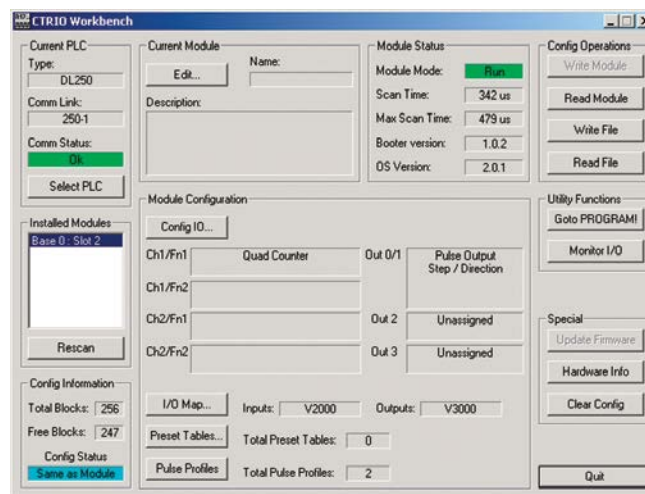

## Supported systems

Multiple T1H-CTRIO modules can reside in the same I/O system provided that the base power budget is adequate.

### PC-based Ethernet I/O control systems

The T1H-CTRIO module can be used in PC-based control systems using the T1H-EBC100 interface module.

### ERM to EBC systems

The T1H-CTRIO module is supported in T1H-EBC100 slaves in H\*-ERM100 systems.

#### Notes:

1. The T1H-CTRIO module is not supported when using the T1K-MODBUS or T1K-DEVNETS controller modules.
2. System functions are not available when CTRIO is used in ERM/EBC expansion I/O.

# High-Speed Counter

## I/O Specifications

General	
<b>Module Type</b>	Intelligent
<b>Modules Per Base</b>	Limited only by power consumption
<b>I/O Points Used</b>	None, I/O map directly in PLC V-memory or PC control access
<b>Field Wiring Connector</b>	Standard removable terminal block
<b>Internal Power Consumption</b>	400mA Max at +5V from Base Power Supply, Maximum of 6 Watts (All I/O in ON State at Max Voltage/Current)
<b>Operating Environment</b>	32°F to 140°F (0°C to 60°C), Humidity (non-condensing) 5% to 95%
<b>Manufacturer</b>	Host Automation Products, LLC
<b>Isolation</b>	2500V I/O to Logic, 1000 V among Input Channels and All Outputs

T1H-CTRIO Input Specifications	
<b>Inputs</b>	8 pts sink/source
<b>Minimum Pulse Width</b>	5 µsec
<b>Input Voltage Range</b>	9-30 VDC
<b>Maximum Voltage</b>	30VDC
<b>Input Voltage Protection</b>	Zener Clamped at 33VDC
<b>Rated Input Current</b>	8mA typical, 12mA maximum
<b>Minimum ON Voltage</b>	9.0 VDC
<b>Maximum OFF Voltage</b>	2.0 VDC
<b>Minimum ON Current</b>	5.0 mA (9VDC required to guarantee ON state)
<b>Maximum OFF Current</b>	2.0 mA
<b>OFF to ON Response</b>	Less than 3 µsec
<b>ON to OFF Response</b>	Less than 3 µsec

T1H-CTRIO Output Specifications	
<b>Outputs</b>	4 pts, independently isolated, current sourcing or sinking FET Outputs: open drain and source with floating gate drive
<b>Voltage Range</b>	5–36 VDC
<b>Maximum Voltage</b>	36VDC
<b>Output Clamp Voltage</b>	60VDC
<b>Maximum Load Current</b>	1.0 A
<b>Maximum Load Voltage</b>	36VDC
<b>Maximum Leakage Current</b>	100µA
<b>Inrush Current</b>	5A for 20ms
<b>OFF to ON Response</b>	Less than 3 µsec
<b>ON to OFF Response</b>	Less than 3 µsec
<b>ON State V Drop</b>	m 0.3 V
<b>External Power Supply</b>	For loop power only, not required for internal module function*
<b>Overcurrent Protection</b>	15A max
<b>Thermal Shutdown</b>	Tjunction = 150°C
<b>Overtemperature Reset</b>	Tjunction = 130°C
<b>Duty Cycle Range</b>	1% to 99% in 1% increments (default = 50%)
<b>Configurable Presets</b>	a) Each output can be assigned one preset, or b) Each output can be assigned one table of presets, one table can contain max. 128 presets, max. predefined tables = 255

\* User supplied power source required for stepper drive configuration.

T1H-CTRIO Input Resources	
<b>Counter/Timer</b>	4, (2 per 4 input channel group) up to 100 kHz
<b>Resource Options</b>	1X, 2X, or 4X Quadrature, Up or Down Counter, Edge Timer, Dual Edge Timer, Input Pulse Catch, Reset, Inhibit, Capture
<b>Timer Range / Resolution</b>	4.2 billion (32 bits); 1 µsec
<b>Counter Range</b>	± 2.1 billion (31 bits + sign bit)

T1H-CTRIO Output Resources	
<b>Pulse output / Discrete outputs</b>	Pulse outputs: 2 channels (2 outputs each channel) Discrete outputs: 4 pts.
<b>Resource Options</b>	Pulse outputs: pulse/direction or cw/ccw; Profiles: Trapezoid, S-Curve, Symmetrical S-Curve, Dynamic Position, Dynamic Velocity, Home Search, Velocity Mode, Run to Limit Mode and Run to Position Mode Discrete outputs: 4 configurable for set, reset, pulse on, pulse off, toggle, reset count functions (assigned to respond to Timer/Counter input functions). Raw mode: Direct access to discrete output from user application program
<b>Target Position Range</b>	± 2.1 billion (32 bits or 31 bits + sign bit)

# High-Speed Counter

## Status indicators

T1H-CTRIO LED Descriptions	
<b>OK</b>	Module OK
<b>ER</b>	User Program Error
<b>1A - 1D</b>	Ch1A - Ch1D Input Status
<b>2A - 2D</b>	Ch2A - Ch2D Input Status
<b>CH1</b>	Channel 1 Status
<b>CH2</b>	Channel 2 Status
<b>Y0 - Y3</b>	Output Status

T1H-CTRIO- LED Diagnostic Definitions		
LED OK	LED ER	Description
<b>ON</b>	OFF	All is well - RUN Mode
<b>ON</b>	ON	Hardware Failure
<b>Blinking</b>	Blinking	Boot Mode - Used for Field OS Upgrades
<b>Blinking</b>	OFF	Program Mode
<b>OFF</b>	Blinking	Module Self-diagnostic Failure
<b>OFF</b>	ON	Module Error Due to Watchdog Timeout
<b>OFF</b>	OFF	No Power to Module

T1H-CTRIO LED Diagnostic Definition	
<b>CH1</b>	Blinks when Channel 1 Function 1 is counting or timing
<b>CH2</b>	Blinks when Channel 2 Function 1 is counting or timing
<b>Y0 - Y3</b>	Follow actual output state; ON = output is passing current

## Installation and wiring

The T1H-CTRIO module has two independent input channels, each consisting of four optically isolated input points (points 1A-1D on common 1M and points 2A-2D on common 2M). The inputs can be wired to either sink or source current. The module has four optically isolated output points (points Y0-Y3 on isolated commons C0-C3, respectively). The outputs must be wired so that positive current flows into the Cn terminal and then out of the Yn terminal (see the diagram below and the schematic on the following page).

The module is configured, using CTRIO Workbench, to accommodate the user's application. The function of each input (counting, timing, reset, etc.) and output (pulse output, discrete output, etc.) is defined in the configuration of the module.

See the notes below for further details about power source considerations, circuit polarities, and field devices.

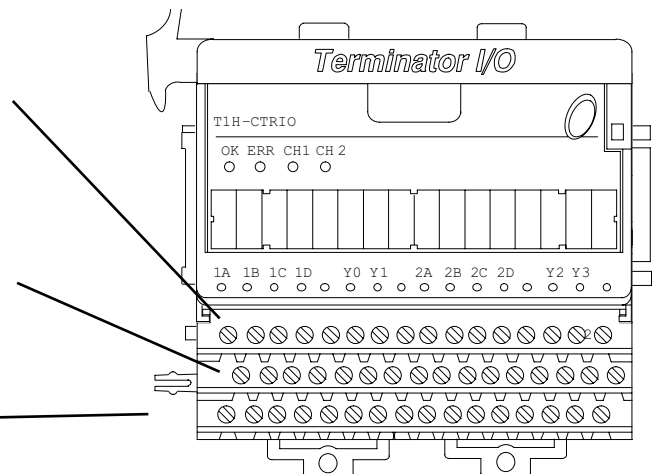
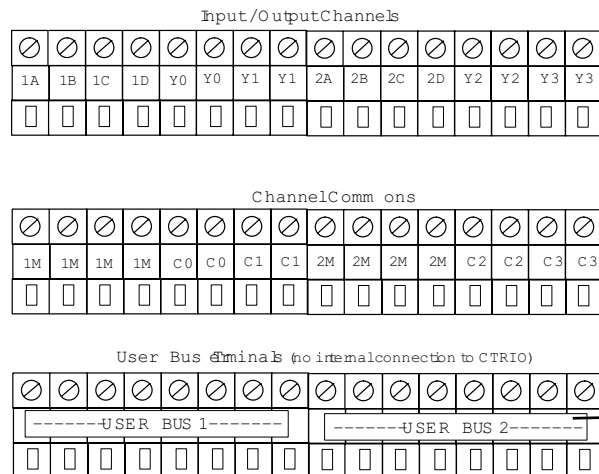

**Notes:**

1. Inputs (1A, 1B, 1C, 1D and 2A, 2B, 2C, 2D) require user-provided 9–30 VDC power sources. Terminals 1M and 2M are the commons for Channel 1 and Channel 2 inputs. Maximum current consumption is 12mA per input point.
2. Polarity of the input power sources can be reversed. Consideration must be given, however, to the polarity of the field device. Many field devices are designed for only one polarity and can be damaged if power wiring is reversed.
3. Outputs have one polarity only and are powered by user-provided 5–36 VDC power sources. The maximum allowable current per output circuit is 1A.
4. User Bus 1 and User Bus 2 are independent 8-wire terminal buses. They can be used for additional power rail connections.

# High-Speed Counter

## Solid state input wiring device

DC types of field devices are configured to either sink or source current. This affects the wiring of the device to the CTRIO module. Refer to the sinking/sourcing section of the appendix in this catalog for a complete explanation of sinking and sourcing concepts.

### NPN Field Device (sink)

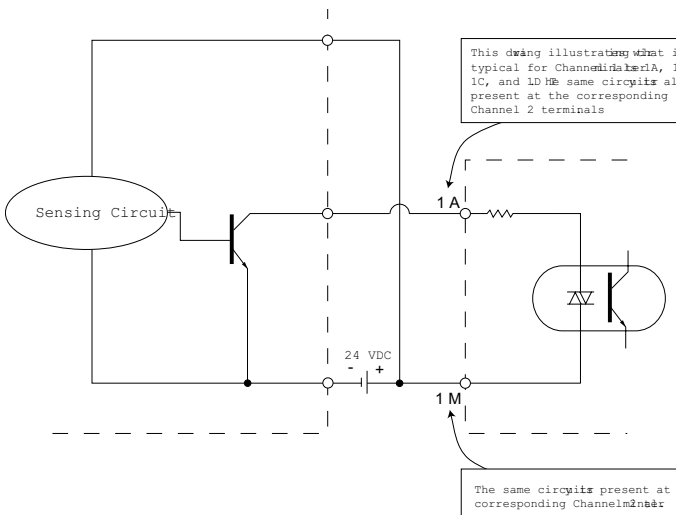

### PNP Field Device (source)

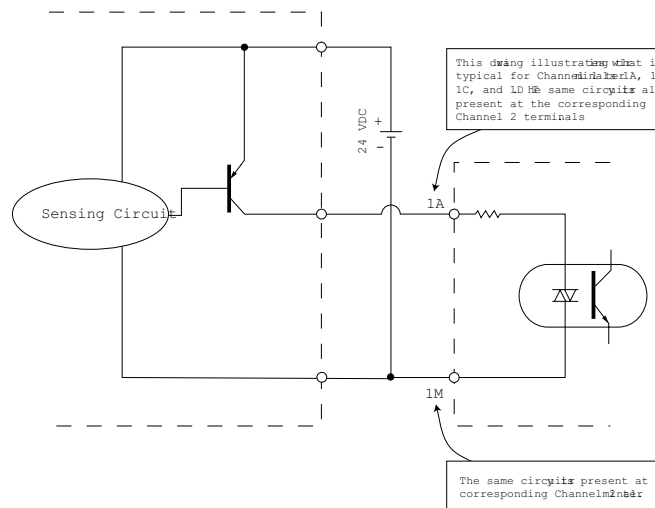

## Pulse output schematic

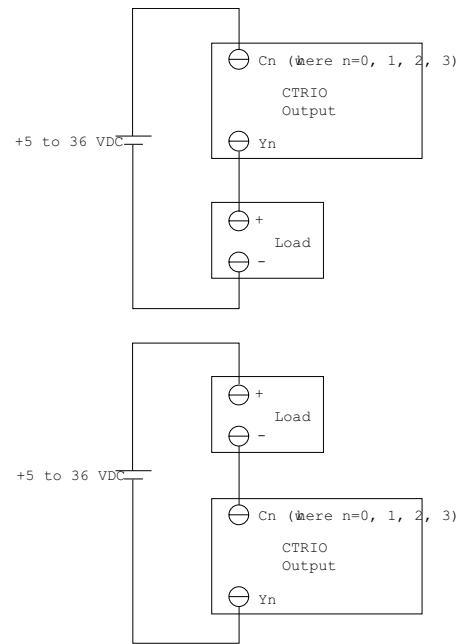

## Stepper/servo drive wiring example

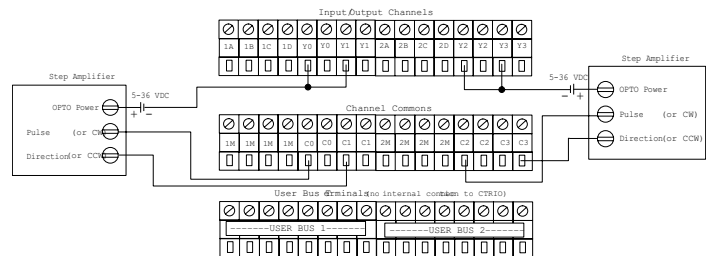

# High-Speed Counter

## Fill-in-the-blank configuration software

The CTRIO Workbench is the software utility used to configure the CTRIO module and to scale signals to desired engineering units. Workbench also allows you to perform various other functions, such as switching between the CTRIO's Program mode and Run mode, monitoring I/O status and functions, and diagnostic control of module functions. The latest version of the CTRIO Workbench utility can be downloaded for free at the Host Engineering's Web site: [www.hosteng.com](http://www.hosteng.com).

### CTRIO Workbench configure I/O setup

The Configure I/O dialog is the location where input and output functions are assigned to the module. The choice of input and output functions determines which options are available. The input function boxes prompt you with selections for supported functions. The Workbench software automatically disallows any unsupported configurations.



**T1H-CTRIO**

CTRIO Workbench main configuration screen

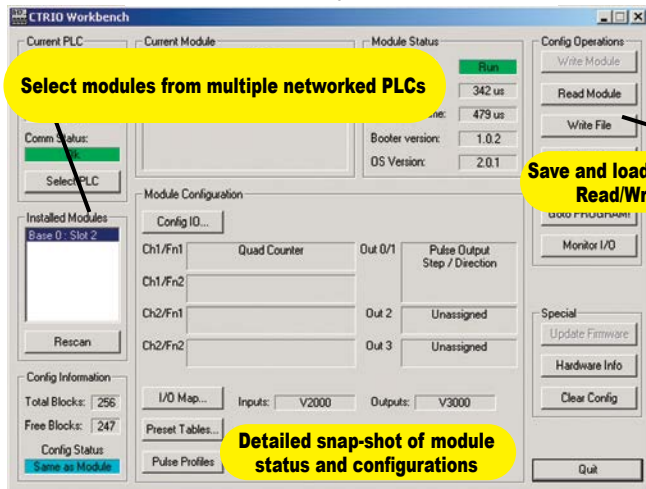

Configure I/O screen

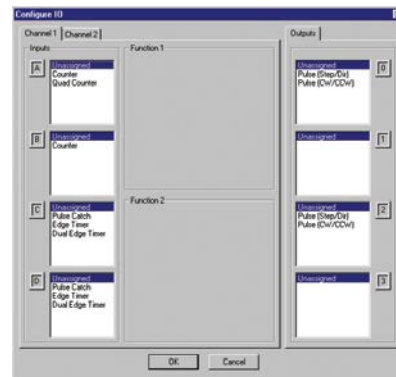

### CTRIO Workbench diagnostics and monitoring

The Monitor I/O dialog is accessible from the main Workbench dialog when the module is in Run Mode. This allows for a convenient way to test and debug your configuration prior to installation. The Monitor I/O dialog is divided into three functional areas: Input Functions, Output Functions and System Functions. The data displayed under the Input Functions tab includes all input Dword parameters, status bits and the current status of each configured input and output function. The fields displayed under the Output Functions tab includes all output Dword parameters and configuration information that can be altered during runtime and the bits that indicate successful transfers or errors. The System Functions can be used to read from or write to the CTRIO's internal registers.

### CTRIO Workbench on-board scaling

Scaling raw signals to engineering units is accomplished using the Scaling Wizard. The Scaling Wizard options are different for the Counter functions as compared with the Timer functions. "Position" and "Rate" scaling are available when you select a Counter function. "Interval" scaling is available when you select a Timing function.

Monitor I/O screen

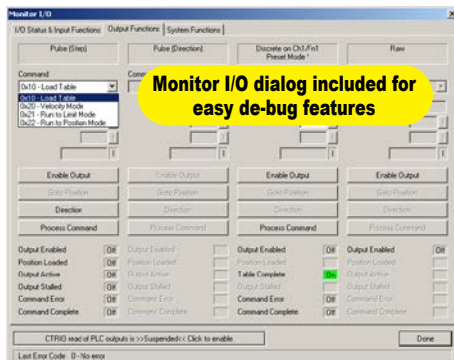

Scaling Wizard screen

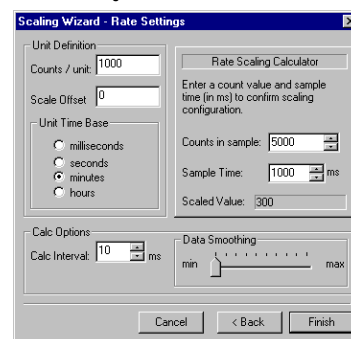



# High-Speed Counter

## High-speed input operations

The CTRIO module is capable of a wide variety of high speed input and output operations all within one module. With its flexible 2-channel input and separate 2-channel output design, the CTRIO can satisfy both high-speed counting, timing, pulse catch operations, along with high speed discrete output or several profile choices of pulse output operations. Not all combinations of input functions and output functions are possible within the resources of the module, but the following examples are some of the most common applications for the CTRIO. Check out these examples and see how they relate to your high speed application needs.

### High-speed timing

The CTRIO can be configured for timing functions based on both count or rate. Using a common configuration of a proximity switch sensing the teeth on a gear, the module is able to calculate the velocity of the gear based on the rate it receives its counts. This value can be scaled within the module to the engineering units required for the application.

### High-speed timing application

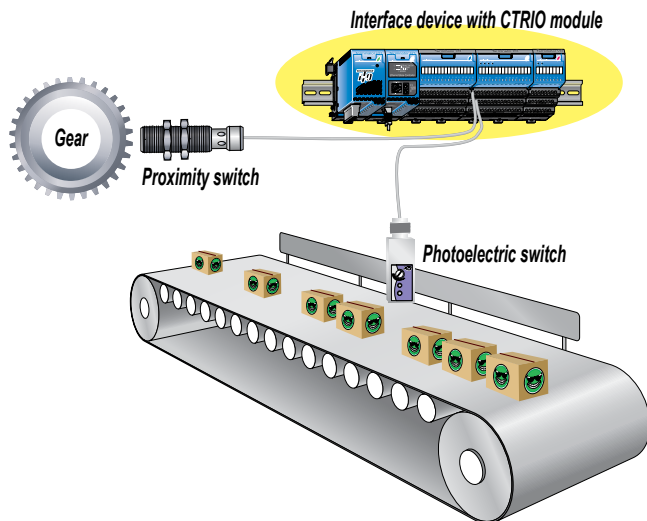

Using Configure I/O screen to configure CTRIO for high-speed timing

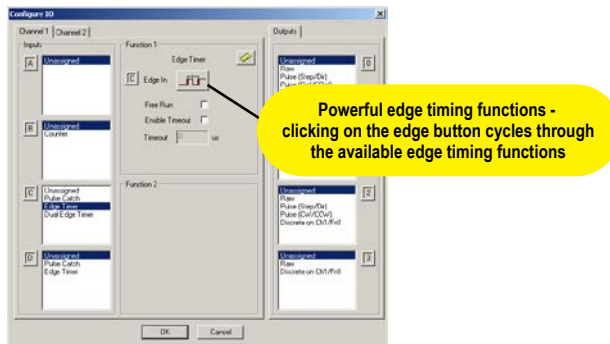

### High-speed counting

The CTRIO can be configured for counting functions for the use of an encoder input, (up to two quadrature encoders per module) with available connections for external reset and inhibit signals. In a simple cut to length application as shown, the encoder provides an input position reference for the material to the module. The module's high speed outputs are wired to the cutting device and to the clutch and/or braking device. When the count from the encoder is equal to a pre-programmed setpoint within the module, the high speed outputs are activated to stop and cut the material to a repeatable fixed length. Additionally, the clutch/brake signal can be used for an inhibit signal to not accumulate counts while the material is being cut.

### High-speed cut-to-length application

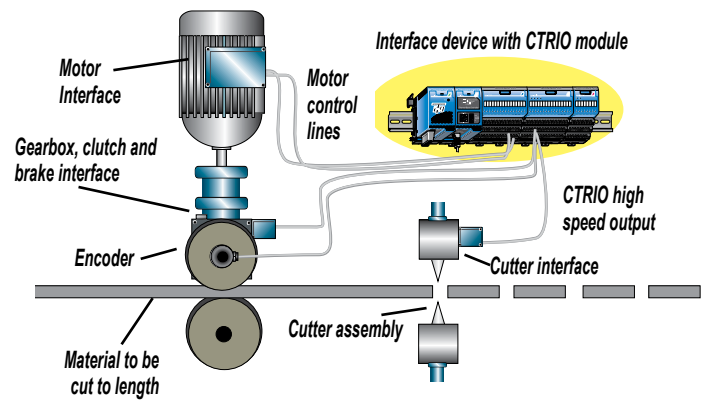

Using Configure I/O screen to configure CTRIO for high-speed counting

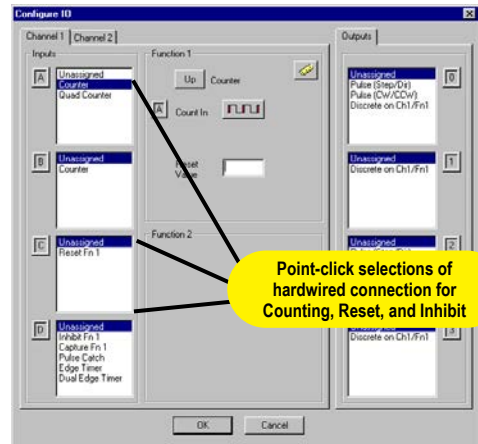

# High-Speed Counter

## Pulse output operations

Using Edit Pulse Profile screen to select Trapezoid pulse output profile

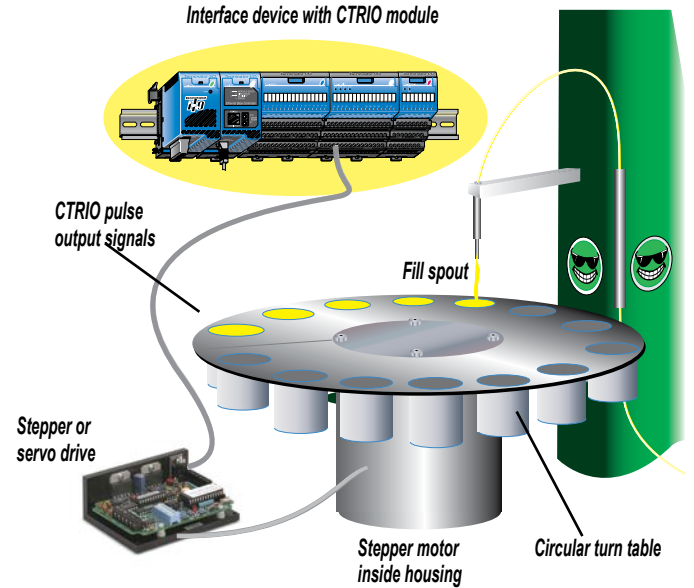
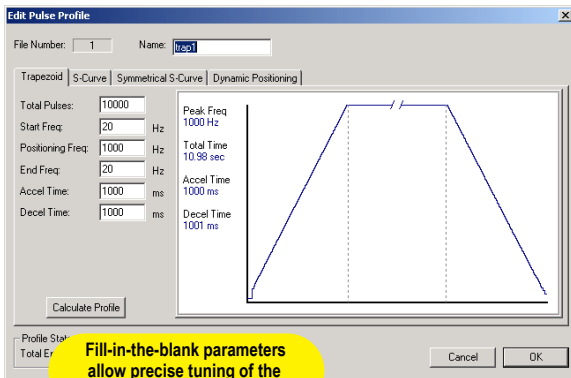

Rotary indexing liquid fill application

### Pulse output for stepper/servo control

The CTRIO module is capable of multiple configurations for pulse output control, most often when connected to a stepper or servo drive system. The module can deliver a pulse output signal up to a maximum of 25kHz on two channels with support for pulse-and-direction or CW/CCW pulses. The available profile choices include Trapezoid, S-Curve, Symmetrical S-Curve, Dynamic Positioning, and Pulse to Limit. All profiles can be easily configured using the CTRIO Workbench software with fill-in-the-blank parameter fields and a graphic representation of the selected profile. Three additional profiles are available that are completely controlled by the user program (no CTRIO profile is configured). They are Velocity Mode, Run to Limit Mode and Run to Position Mode.

### Example application

In a simple rotary indexing application, as shown above, a fixed Trapezoid profile is chosen. The CTRIO for this application is wired to a stepper drive for pulse-and-direction. The requirement for this application is to provide a smooth movement of the rotary table to allow product to be filled into individual containers equal distance apart. The predetermined number of pulses required for each movement is entered into the CTRIO Workbench as "Total Pulses" along with the Starting Frequency, Ending Frequency, and Positioning Frequency (speed after acceleration). The Acceleration and Deceleration parameters are entered in units of time, so no ramp-distance calculations are required. After all parameters are entered, a graphical representation of the configured profile is shown automatically. Once the configuration has been downloaded to the module, all that is needed from the PLC CPU is the Enable Output signal to begin a movement.

### Other common pulse output applications:

- S-Curve accel/decel profile for signaling a stepper or servo drive that needs a curved acceleration and deceleration profile, i.e. for diminishing any initial "jerk" upon movement of static products, boxes on conveyors, liquids in containers on an indexer, printing registrations, etc.
- Dynamic Positioning for any run-to-a-specific-position requirement, either by a pre-programmed count of an external high speed discrete input wired to the module. This is popular in winding or web vcontrol with any dynamic registration mark or variable speed requirement.
- Home Search routines to seek a home position based on CTRIO discrete input limit(s).

Example of S-Curve acceleration and deceleration pulse output profile

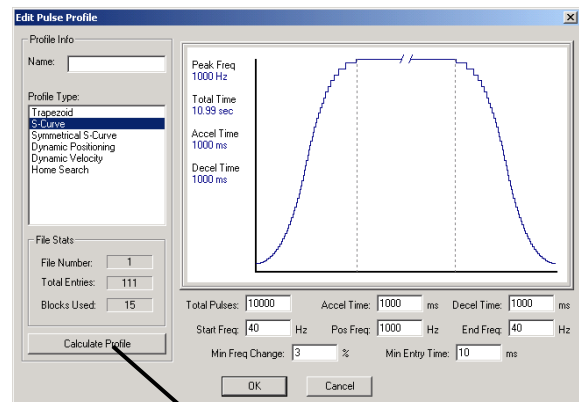

# High-Speed Counter

## Combining high-speed input and pulse output operations

Using CTRIO Workbench to configure the module for simultaneous high-speed input and high-speed pulse output operation.

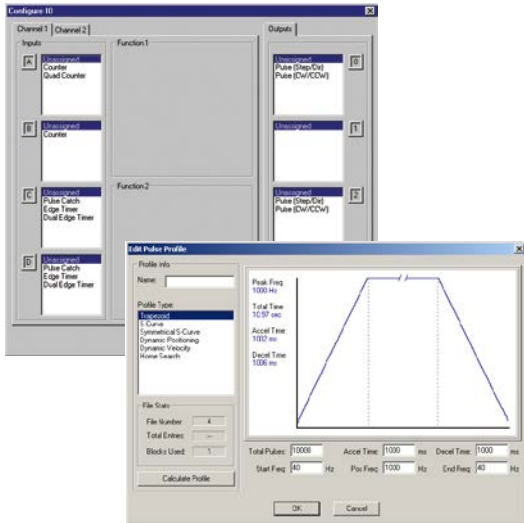

Multi-head drill machine application

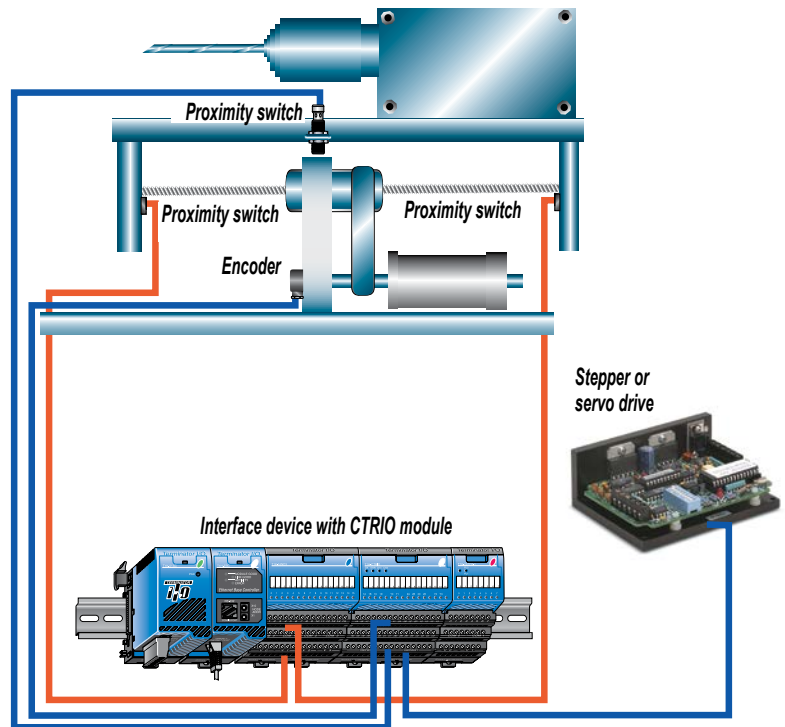

### High-Speed inputs and pulse output combinations

The flexible design of the CTRIO module allows for combining high speed inputs and delivering high speed pulse outputs signals simultaneously. There are limitations to this type of configuration in that the module does not internally support closed loop control. Providing closed loop control with the CTRIO involves additional PLC code to coordinate this control, making the application subject to the PLC CPU program scan. Simple position/speed monitoring, via a high speed counting input for non-critical response while providing pulse outputs to a drive, is easily achievable for the CTRIO.

### Example application

In the simple drill-head application shown above, the CTRIO pulse outputs are wired to a stepper and/or servo drive. The inputs are wired to an encoder attached to the lead screw on the movable portion of the drill-head assembly. The CTRIO module output pulse train to the drive allows the motor to spin the lead screw making the drill move forward into the passing material. The encoder monitors the speed and position of the drill-head. Prox switches at each end act as limit switches ensuring the drill-head will not over-travel. A home sensor is positioned in the middle of the assembly, allowing the PLC to reset the count.

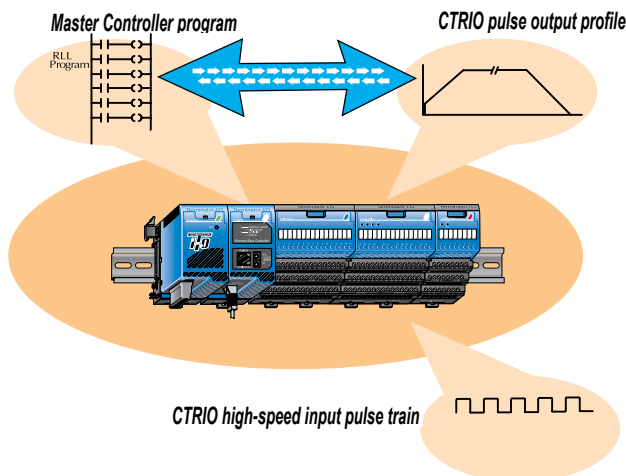

Note: Closed loop control for the CTRIO module requires control program interaction to close the loop. This makes the application subject to the master controller scan.



# Dimensions and Installation

It is important to understand the installation requirements for your Terminator I/O system. This will ensure that the Terminator I/O products work within their environmental and electrical limits.

## Plan for safety

This catalog should never be used as a replacement for the technical data sheet that comes with the products or the T1K-INST-M Installation and I/O Manual (available online at [www.automationdirect.com](http://www.automationdirect.com).) The technical data sheet contains information that must be followed. The system installation should comply with all appropriate electrical codes and standards.

## Unit dimensions and mounting orientation

Use the following diagrams to decide if the Terminator I/O system can be installed in your application. Terminator I/O units should be mounted horizontally. To ensure proper airflow for cooling purposes, units should not be mounted upside-down. It is important to check the Terminator I/O dimensions against the conditions required for your application. For example, it is recommended to leave 2" depth for ease of access and cable clearance. However, your distance may be greater or less. Also, check the installation guidelines for the recommended cabinet clearances.

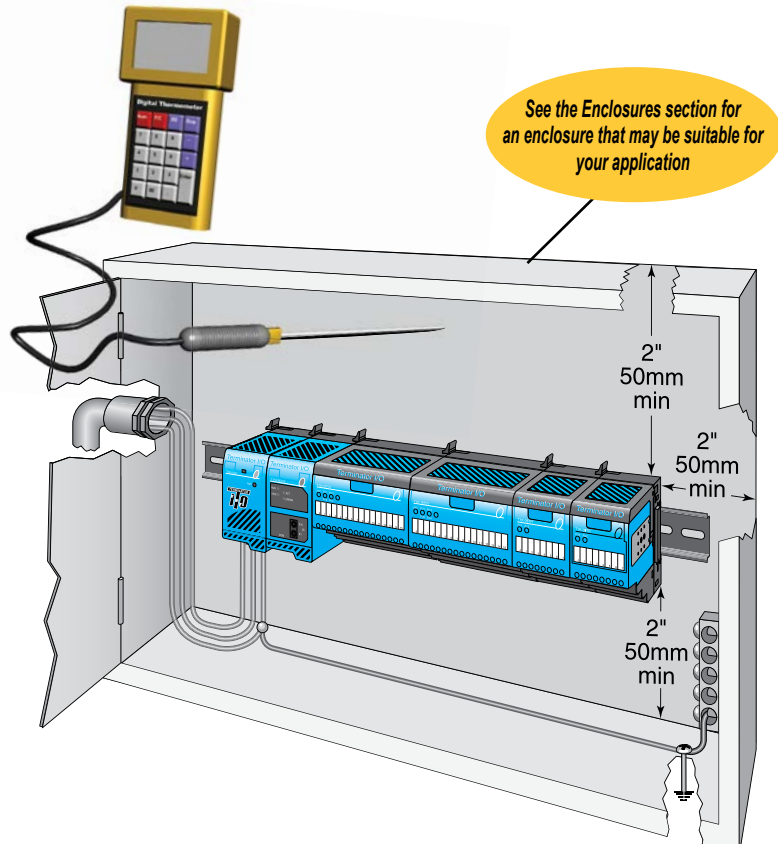

Terminator I/O Environmental Specifications	
<b>Ambient Operating Temperature</b>	32°F to 131°F (0°C to 55°C)
<b>Storage Temperature</b>	-4°F to 158°F (-20°C to 70°C)
<b>Ambient Humidity</b>	5% to 95% (Non-condensing)
<b>Atmosphere</b>	No corrosive gases. The level of environmental pollution = 2 (UL 840)
<b>Vibration Resistance</b>	MIL STD 810C, Method 514.2
<b>Shock Resistance</b>	MIL STD 810C, Method 516.2
<b>Voltage Withstand (Dielectric)</b>	1500VAC, 1 minute
<b>Insulation Resistance</b>	500 VDC, 10 M $\Omega$
<b>Noise Immunity</b>	NEMA ICS3-304 Impulse noise 1 $\mu$ s, 1000V FCC class A RFI (144MHz, 430MHz 10W, 10cm)
<b>Agency Approvals</b>	UL, CE, FCC class A, NEC Class 1 Division 2

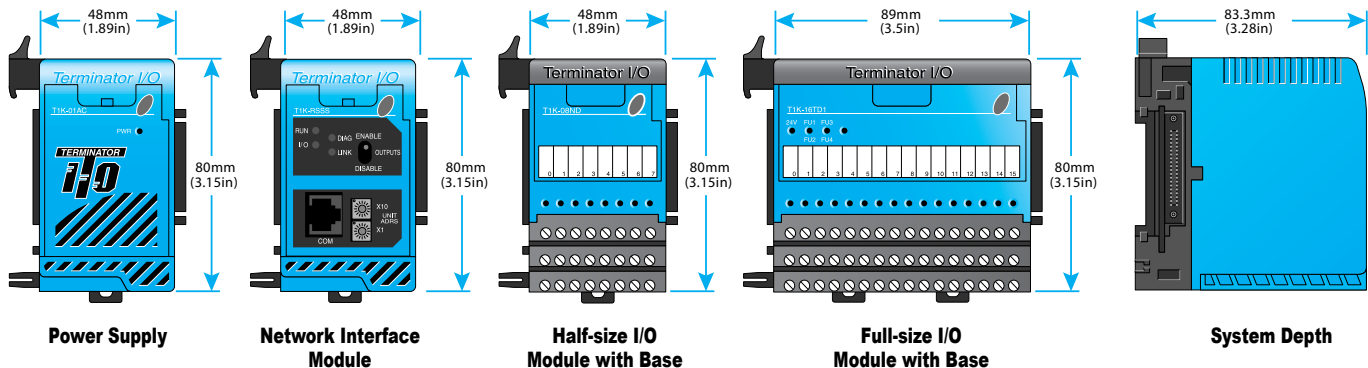

# I/O Module Installation

## I/O module installation

Terminator I/O modules feature separate terminal bases for easy installation.

To install I/O modules:

1. Slide the module into its terminal base (until it clicks into position)
2. Hook upper DIN rail tabs over the top of DIN rail, and press the assembly firmly onto the DIN rail.
3. Slide the module along the DIN rail until it engages with the adjacent module.

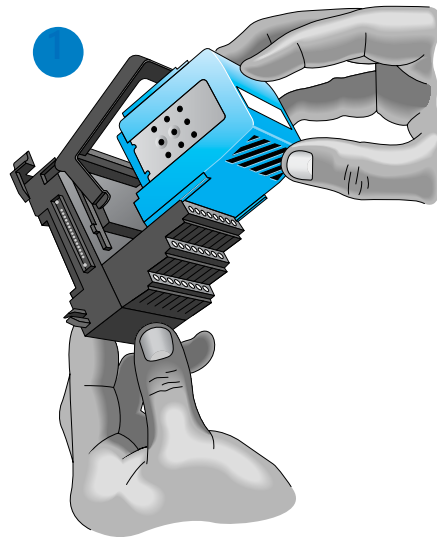

### DN-ASB1 angled mounting bracket

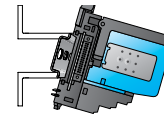
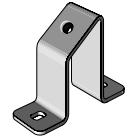

Great for mounting in upper locations

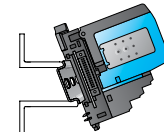

Great for mounting in lower locations

Optional angled support bracket raises and tilts the mounting rail for easier access and wiring. Use with 35mm DIN rail. See the Connection Systems in this catalog for details.

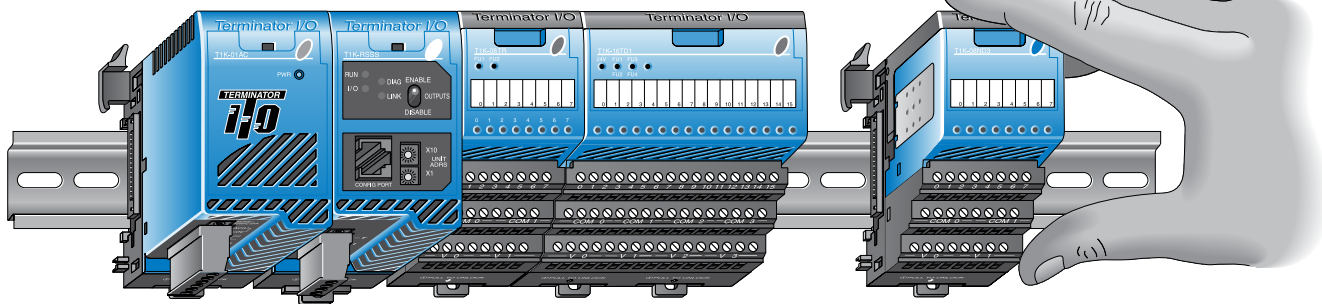
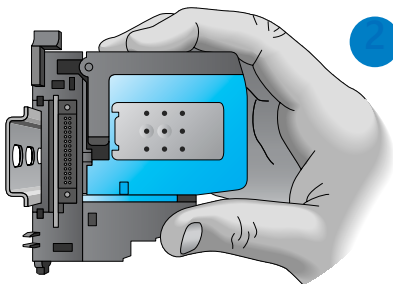

## Removing I/O modules is a snap

Grip the locking handle, as shown, and pull gently to eject the I/O module from its base. The module will slide out for easy replacement. This procedure does not apply to network interface modules or power supplies, which have integral bases.

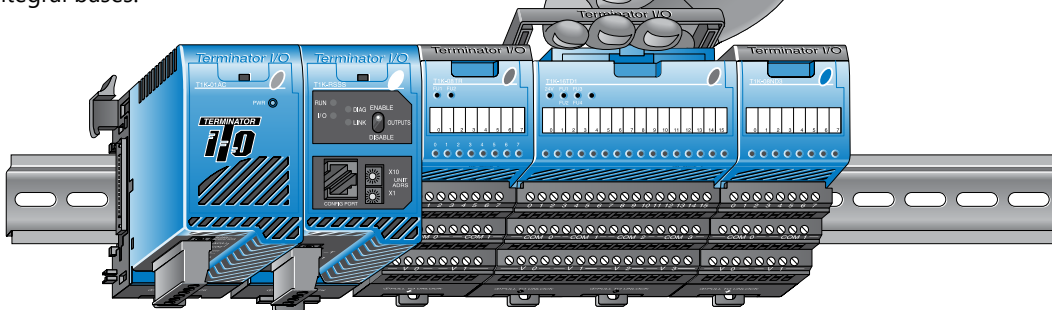

### Hot-swappable I/O modules

You can remove I/O modules under power, but exercise caution while doing so. Do not touch the terminals with your hands or any conductive material. Always remove power when possible.

# Power Supplies and Power Requirements

## Power supplies

The Terminator I/O product line offers two power supply options: AC or DC. The power supplies are always positioned to the left of the modules to which they supply power. Consult the system configuration examples and the power budgeting example for more information on positioning power supplies.

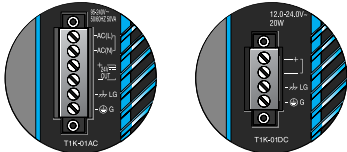

## Power supply specifications

Power Supply Specifications		T1K-01AC \$159.00	T1K-01DC \$167.00
<b>Input Voltage Range</b>		110/220 VAC	12/24 VDC
<b>Input Frequency</b>		50/60 Hz	N/A
<b>Maximum Power</b>		50VA	30W
<b>Max. Inrush Current</b>		20A	10A
<b>Insulation Resistance</b>		> 10M $\Omega$ @ 500 VDC	
<b>Voltage Withstand</b>		1 min. @ 1500VAC between primary, secondary and field ground	
<b>5VDC PWR</b>	<b>Voltage</b>	5.25 VDC	5.25 VDC
	<b>Current Rating</b>	2000 mA max (see current option note below)	2000mA max
	<b>Ripple</b>	5% max.	5% max.
<b>24VDC PWR</b>	<b>Voltage</b>	24VDC	N/A
	<b>Current Rating</b>	300mA max. (see current option note below)	N/A
	<b>Ripple</b>	10% max.	N/A
<b>Fuse</b>	1 (primary), not replaceable		
<b>Replacement Terminal Block (Phoenix Contact)</b>	MVSTBW 2.5/4-ST- 5.08 BK	MVSTBW 2.5/6-ST- 5.08 BK	
<b>Note:</b> 500mA @ 24VDC can be achieved by lowering the 5VDC from 2000mA to 1500mA.			

## Power requirements

Module	5VDC	24VDC	Module	5VDC	24VDC	Module	5VDC	24VDC			
<b>Interface Modules</b>			<b>DC Output Modules</b>			<b>Analog Input Modules</b>					
<b>T1H-EBC100</b>	300	0	<b>T1H-08TDS</b>	200	0	<b>T1F-08AD-1</b>	75	50*			
<b>T1K-DEVNETS</b>	250	45	<b>T1K-08TD1</b>	100	200*	<b>T1F-08AD-2</b>	75	50*			
<b>T1K-MODBUS</b>	300	0	<b>T1K-16TD1</b>	200	400*	<b>T1F-16AD-1</b>	75	50*			
<b>DC Input Modules</b>			<b>T1K-08TD2-1</b>	200	0	<b>T1F-16AD-2</b>	75	50*			
<b>T1K-08ND3</b>	35	0	<b>T1K-16TD2-1</b>	200	0	<b>T1F-16RTD</b>	150	0			
<b>T1K-16ND3</b>	70	0	<b>AC Output Modules</b>			<b>T1F-16TMS</b>	150	0			
<b>AC Input Modules</b>			<b>T1K-08TA</b>			250	0	<b>T1F-14THM</b>	60	70*	
<b>T1K-08NA-1</b>	35	0	<b>T1K-16TA</b>			450	0	<b>Analog Output Modules</b>			
<b>T1K-16NA-1</b>	70	0	<b>T1K-08TAS</b>			300	0	<b>T1F-08DA-1</b>	75	150*	
			<b>Relay Output Modules</b>						<b>T1F-08DA-2</b>	75	150*
			<b>T1K-08TR</b>			350	0	<b>T1F-16DA-1</b>	75	150*	
			<b>T1K-16TR</b>			700	0	<b>T1F-16DA-2</b>	75	150*	
			<b>T1K-08TRS</b>			400	0	<b>Combination Analog Modules</b>			
			<b>Specialty Modules</b>						<b>T1F-8AD4DA-1</b>	75	60*
			<b>T1H-CTRIO</b>			400	0	<b>T1F-8AD4DA-2</b>	75	70*	
			* Use either internal or external source for 24VDC						* Use either internal or external source for 24VDC		

### Calculating the power budget

To calculate the power budget, read the available power (current rating) from the Power Supply Specifications table and subtract the power consumed by each module to the right of the power supply. Do not include modules to the right of an additional power supply.

### Adding additional power supplies

Each power supply furnishes power only to the network interface and I/O modules to its right. Inserting a second power supply closes the power loop for the power supply to the left, while also powering the modules to its right. Perform a power budget calculation for each power supply in the system.

Power Budget Example		
Module	5VDC	24VDC
<b>T1K-01AC</b>	+2000mA	+300mA
<b>T1H-EBC100</b>	-300mA	-0mA
<b>T1K-16ND3</b>	-70mA	-0mA
<b>T1K-16TD2</b>	-200mA	-0mA
<b>T1F-08AD-1</b>	-75mA	-50mA
<b>Remaining</b>	+1355mA	+250mA

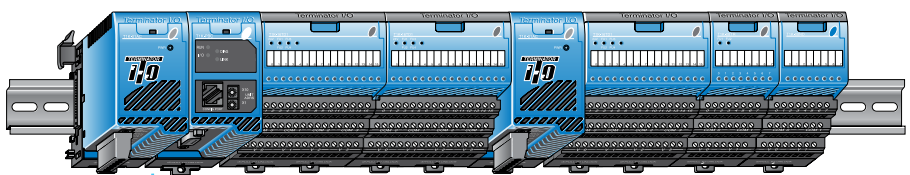

This power supply powers the network interface module and the next two I/O modules

This power supply powers these three I/O modules

# Expansion I/O Configurations

## Expansion cables

<b><u>T1K-10CBL</u></b>	<b>\$104.00</b>
<b><u>T1K-10CBL-1*</u></b>	<b>\$138.00</b>

### **Right side to left side expansion cable**

The T1K-10CBL(-1) connects the right side of an I/O base to the left side of the next I/O base. A maximum of two T1K-10CBL(-1) cables can be used per expansion system.



\*Note: The (-1) versions of the expansion cables pass 24VDC through on an isolated wire. (All cables pass the 5VDC base power.) Any local expansion DC input module configured for "internal power" (current sourcing) must either have a power supply preceding it on the same base or, have a (-1) version cable pass 24VDC from a power supply on the preceding base.

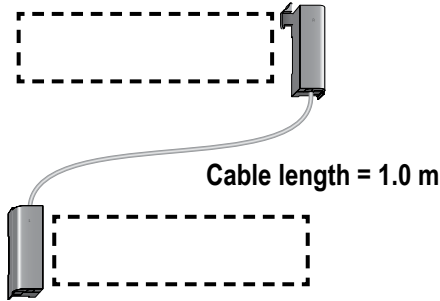

### **Using two T1K-10CBL expansion cables**

In the system below, power supplies can be used anywhere.

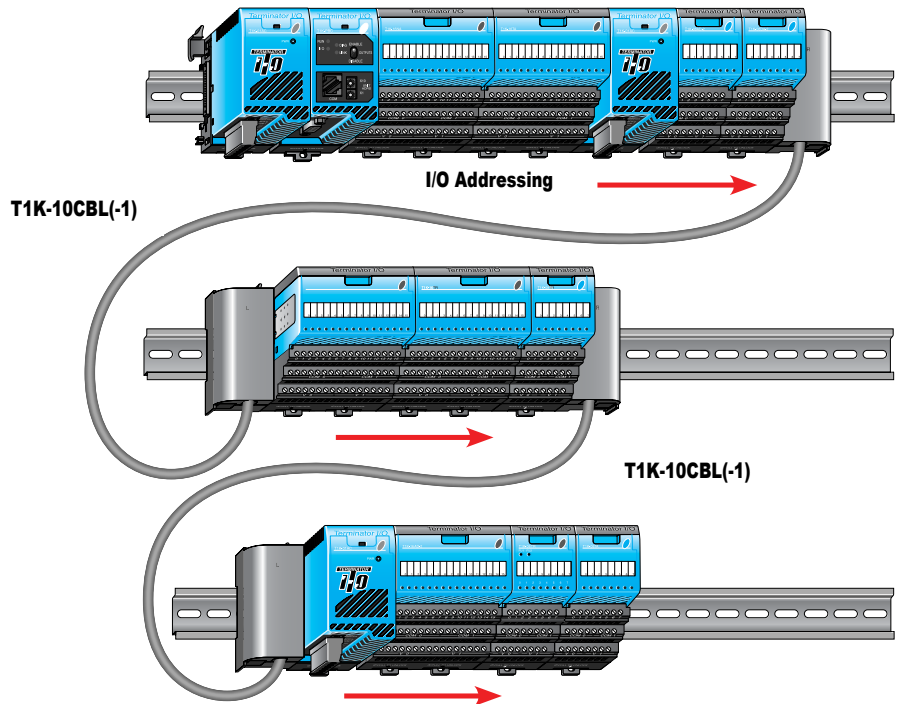



# Field Device Wiring and Power Options

## Terminal base specifications

Terminator I/O terminal bases are available in screw clamp and spring clamp versions for both half-size and full-size modules. Hot stamp silk screen labeling is used for numbering I/O points, commons, and all power terminals.

Terminal Base Specifications		
<b>Terminal Type</b>	Screw type	Spring clamp
<b>Recommended Torque</b>	1.77–3.54 lb-in (0.2–0.4 N·m)	N/A
<b>Wire Gauge</b>	Solid: 25–12 AWG	Solid: 25–14 AWG
	Stranded: 26–12 AWG	Stranded: 26–14 AWG

### Field device wiring options

Power your DC input devices from the integrated 24VDC power supply bus. T1K-08ND3 and T1K-16ND3 DC input modules include jumpers for selecting the internal 24VDC power supply available for 2- and 3-wire field devices. Clearly labeled triple stack terminals make it easy to wire 2- and 3-wire devices ensuring clean wiring with only one wire per termination.

External user supplied 24VDC power, or auxiliary 24VDC terminals from T1K-01AC, can be easily applied directly to one end of the terminal rows and jumpered across each base in the system.

This is a convenient solution for powering analog I/O and discrete DC output devices whose modules do not have direct access to the internal bussed 24VDC. If current consumption increases, simply add additional T1K-01AC power supplies into the system.

T1K-08B \$119.00

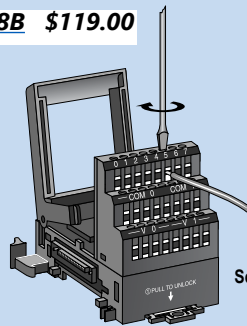

Screw clamp, half-size

T1K-08B-1 \$129.00

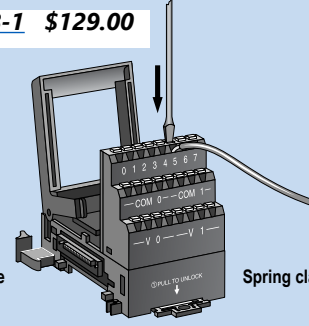

Spring clamp, half-size

T1K-16B \$152.00

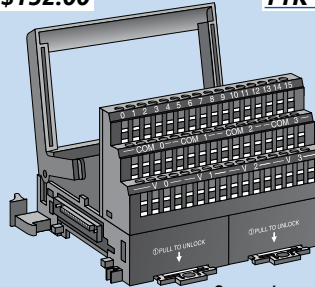

Screw clamp, full-size

T1K-16B-1 \$155.00

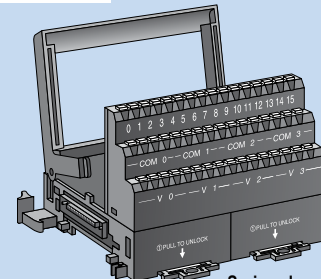

Spring clamp, full-size

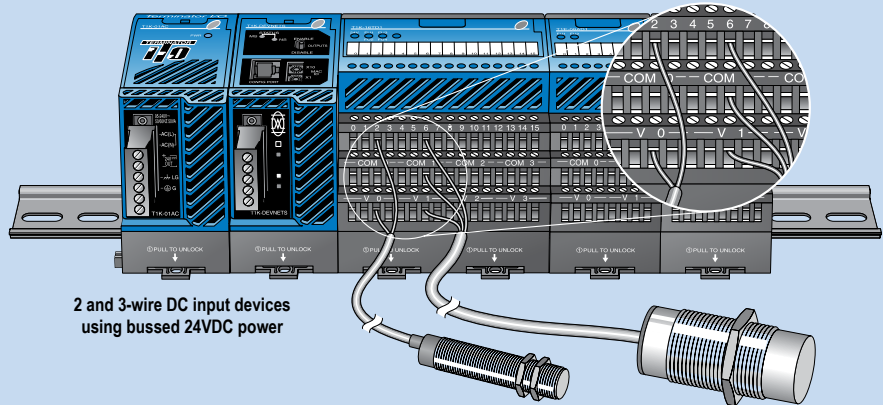

2 and 3-wire DC input devices using bussed 24VDC power

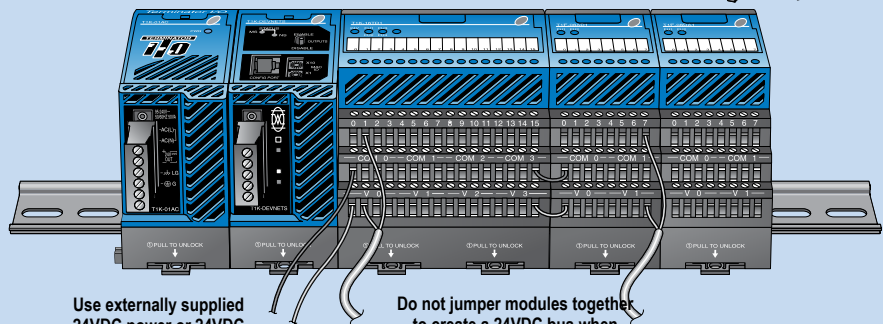

Use externally supplied 24VDC power or 24VDC auxiliary power from T1K-01AC

Do not jumper modules together to create a 24VDC bus when using the "hot swap" feature. See Note below.

## Hot-swap feature

The hot-swap feature allows Terminator I/O modules to be replaced while system power is on. Be careful not to touch the terminals with your hands or other conductive material to avoid the risk of personal injury or equipment damage. Always remove power if it is equally convenient to do so.

Note: Before hot-swapping analog or

DC output modules in a Terminator I/O system, make sure that each of the analog and DC output module's 24VDC and 0 VDC base terminals are wired directly to the external power supply individually. If the external 24VDC and 0 VDC is jumpered from base to base in a daisy chain fashion, and an analog or DC output

module is removed from its base, the risk of disconnecting the external 24VDC and 0 VDC to the subsequent I/O modules exists.