

Stepper Systems

Complete SureStep system in 4 components: Power Supply, Stepper Drive, Motor Extension Cable, Motor. Standard Drives (pulse and direction input; DIP-switch configuration) and Advanced Drives (communication/analog control and setup) are available.

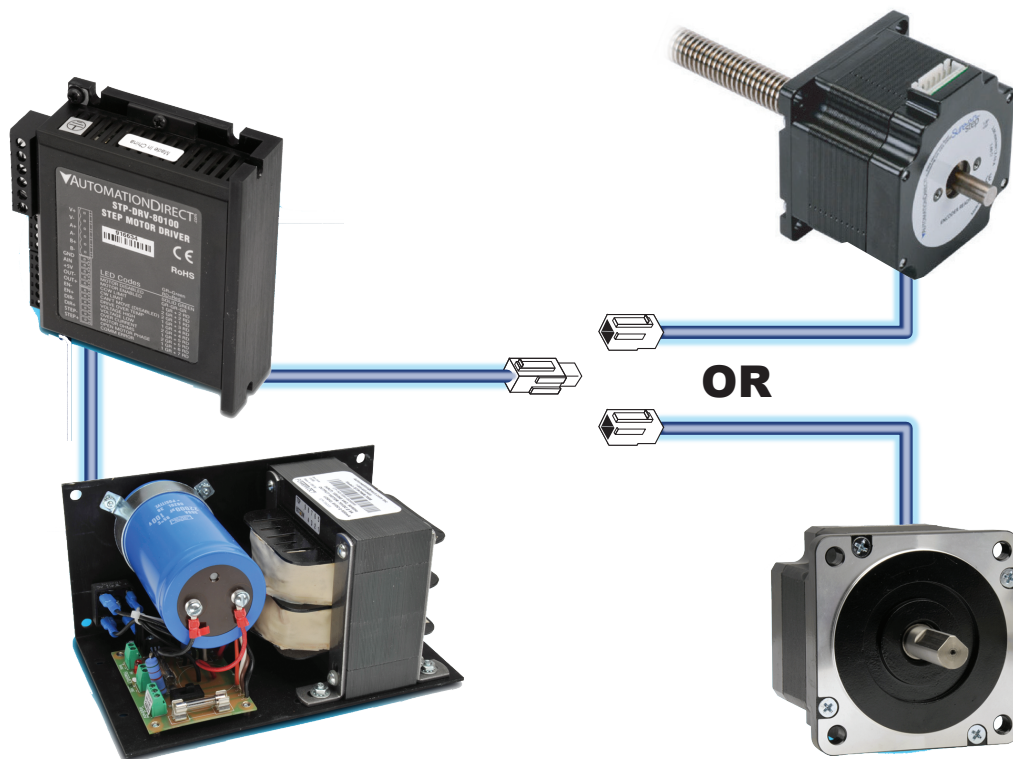

Complete SureStep system in 2 components: Power Supply and Integrated Stepper Motor/Drive. Standard Motor/Drives (pulse and direction input; DIP-switch configuration) and Advanced Motor/Drives (communication/analog control and setup) are available.

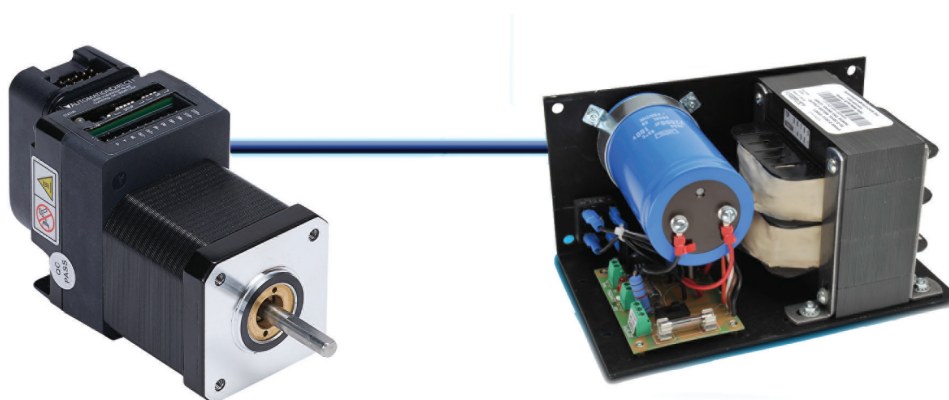



Stepping System Overview

High-performance microstepping drives with high-torque stepping motors

SureStep stepping systems provide simple and accurate control of position and speed. Pulses (or “step” and “direction” signals) from an AutomationDirect PLC or other indexer and motion controller are “translated” by the microstepping drive into precise movement of the stepping motor shaft. The SureStep stepping motors use 2-phase technology with 200 full steps per revolution or 1.8° per full step. Older type stepping motor drives, which operate stepping motors in full step mode, can result in stalling or lost motion due to potential problems with low speed mechanical vibration (usually between 100 to 200 RPM). To minimize this vibration problem, the SureStep microstepping drives use advanced microstepping technology to smooth the motor motion and stepping response. The SureStep family has options for open loop control (no encoder), position monitoring (external encoder feedback), and inclusive position verification (integrated motor/drives with internal encoder). Inclusive position verification provides for stall prevention and detection along with position completion after a temporary stall.

SureStep stepper drives support a wide range of selectable microstep resolutions, from 200 steps per revolution (full step) to 51,200 (full step ÷ 256) steps per revolution, depending on model.

The advanced drives can operate with traditional high-speed inputs, but can also be commanded via 0–5V analog input. They have an internal indexer that can accomplish point-to-point moves controlled via ASCII communication.

FREE configuration software!

SureMotion Pro software is available that makes setting parameters a snap for the advanced drives and advanced integrated motor/drives! SureMotion Pro replaces SureStep Pro configuration software. Download free from our website:

<https://support.automationdirect.com/products/surestep.html>

Standards and Agency Approvals

How fast can my system go?

Maximum Potential Speed Chart (rpm) *					
PLC		SureStep Drive Steps/Rev Selection **			
Model	Max Output (kHz)	400 Steps/Rev	1000 Steps/Rev	2000 Steps/Rev	10,000 Steps/Rev
DL05, DL105	7	1,050	420	210	42
DL06	10	1,500	600	300	60
H0/H2/H4/T1H-CTRIO	25	>2,500***	1,500	750	150
H2-CTRIO2	250	>2,500***			1,500
P2-HSO	1000	>2,500***			
P3-HSO	1000	>2,500***			
BRX	2000	>2,500***			

* These speeds are theoretical maximums. See torque curves of specific motors for their rpm limits.

** Full step (200 steps/rev) will allow higher top speed.

Full stepping, however, can create vibration at low speed.

*** Typical stepper systems do not run faster than 2500 rpm.

Stepping Motor RPM = (A ÷ B) x (60 seconds/minute)

Where: A = PLC output frequency (pulses per second)
 B = microstepping resolution selection (steps/revolution)

Maximum RPM = $\frac{\text{Steps/Sec } A}{\text{Steps/Rev } B} \times \text{Sec/Min}$

Example 1: $1,500 = \frac{10,000}{400} \times 60$
 DL06 with 10 kHz Built-in Pulse Output

Example 2: $3,750 = \frac{25,000}{400} \times 60$
 Hx-CTRIO with 25 kHz Pulse Output



Stepping System Overview

Two or Four components to make a complete system

Choose an integrated motor/drive and power supply

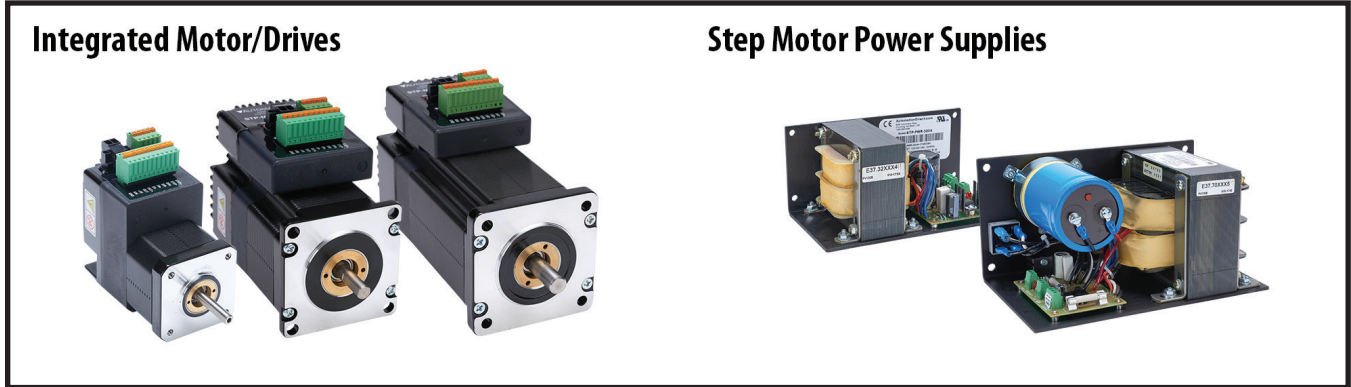

OR ...

Choose a separate drive, motor, motor extension cable and power supply

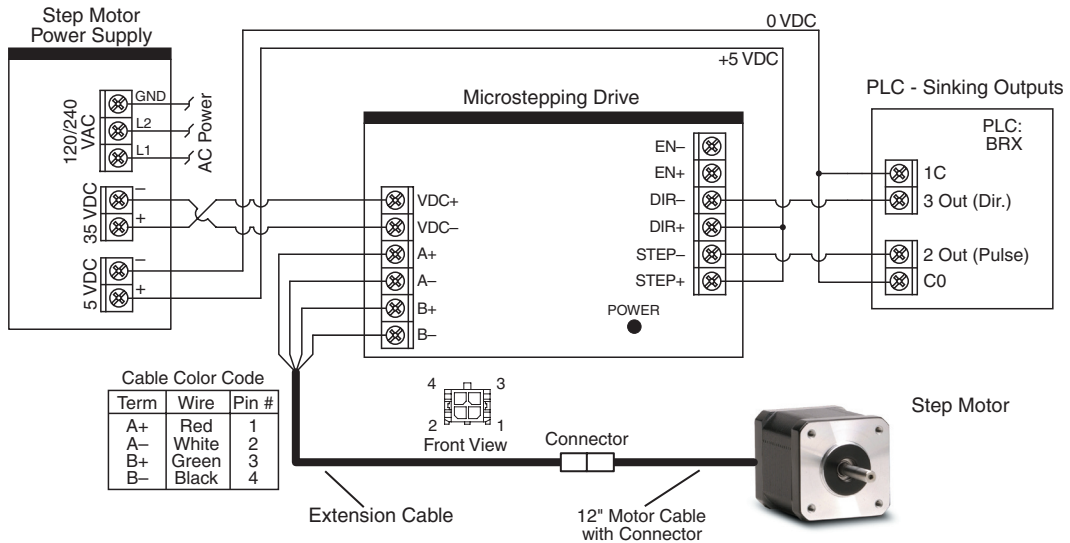
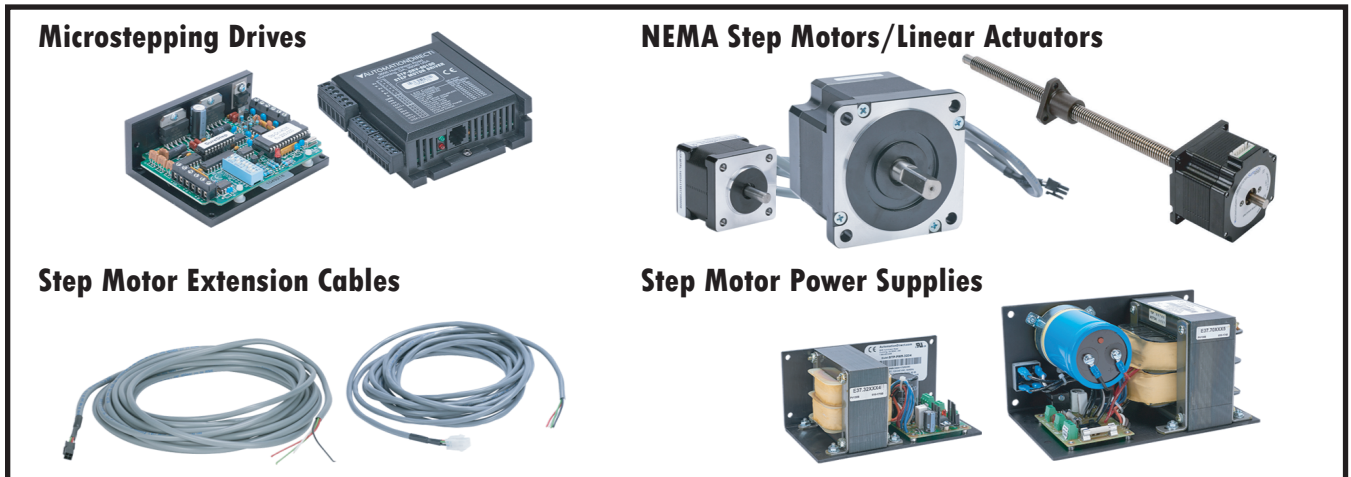



Stepping System Overview

NEMA frame stepping motors

The SureStep stepping family has a wide variety of high-torque motors to handle a wide range of automation applications such as woodworking, assembly, and test machines. The motors are available in both single-shaft and dual-shaft configurations, with or without an encoder. Our square frame or "high-torque" style stepping motors are the latest in bipolar technology, resulting in very high torque to volume ratios. We have NEMA 14, 17, 23, 34, and 42 size motors with holding torque ranging from 8 to 4532 oz-in. Wash down "W" motors (IP65) are also available. Optional 6, 10, or 20-foot extension cables with locking connectors are available to interface any of the stepping motors to the microstepping drive, except the NEMA 23 and NEMA 34 STP-MTRAC-x motors. Those MTRAC motors have an integrated 10-foot pigtail cable. The

extension cables can be easily cut to length, if desired. Integrated motor/drives and separate motors with an "E" in their part number include an encoder for position feedback. The MTRAC motors are designed to work with 115 or 230 VAC powered drives and can withstand high voltages. This allows higher torque, especially at higher speeds.

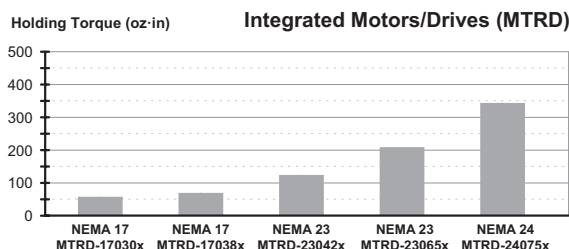
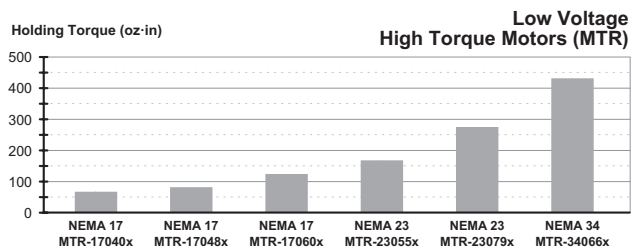
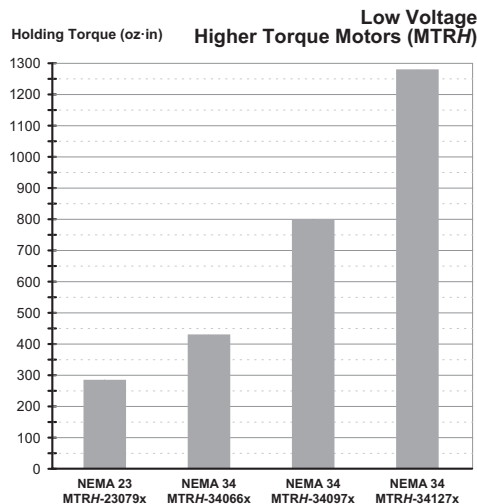
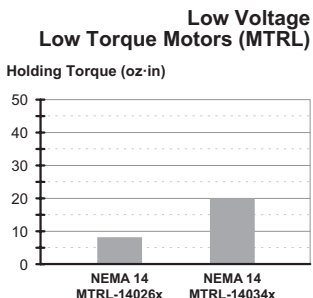

Note that the integrated motor/drive systems have a lower maximum torque due to heat constraints with the drive connected to the motor. For solutions requiring the highest torque, use the systems with our NEMA MTRH (low voltage, higher torque) or MTRAC (high voltage, high torque) motors.

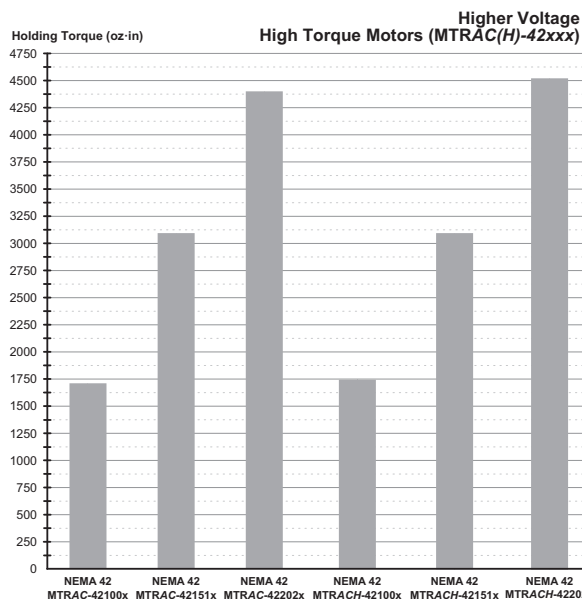
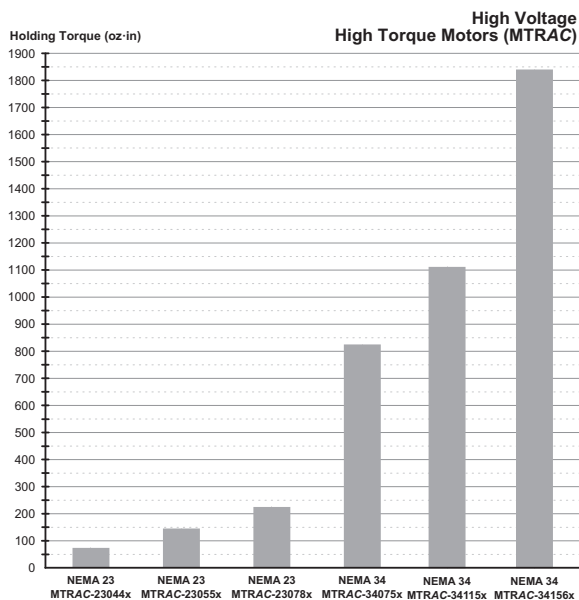

Note: While possessing similar holding torques, the MTRACH motors have much higher torque at high speeds than the MTRAC motors.



Stepping System Overview

NEMA frame stepping motors, continued

SureStep Stepper Linear Actuators combine all the great features of our stepper motors with a lead screw as the motor's shaft. NEMA 17 and 23 frame size motors are available with leads from 1.25mm/rev to 1inch/rev.

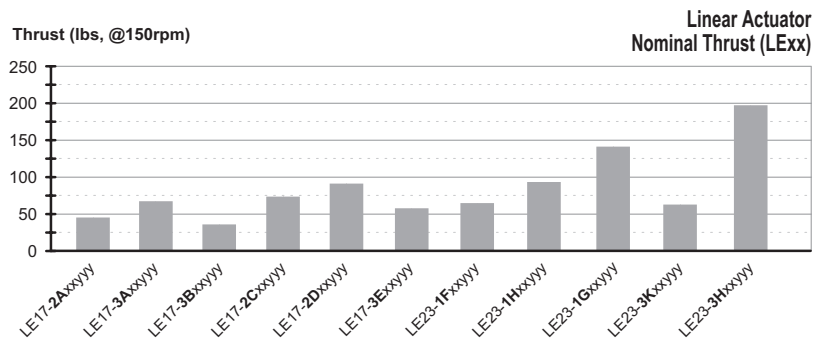

High-performance microstepping drives

SureStep microstepping drives

(STP-DRV-4035, -4830, -4845, -6575, & STP-MTRD-x)

- Standard high-speed pulse input (pulse and direction)
- On-board or removable screw terminals for easy hook-up
- Optically-isolated inputs ready for +5VDC logic from AutomationDirect PLCs, or 5–24 VDC (depending on model)
- No software or add-on resistors required for drive configuration; dipswitch and/or rotary-dial setup
- Dipswitch used for built-in self-test, microstep resolution selection, current level selection, and optional idle current reduction.
- Optional external encoder feedback for integrated models

SureStep high bus voltage microstepping drives

(STP-DRVAC-24025)

- Auto-setup measures motor parameters and configures motor current control and anti-resonance gain settings
- Uses universal AC input 90 to 240 VAC, AC input voltage must be selected by switch
- Switch selectable microstep resolution, 16 settings from 200 to 25600 steps/rev
- Switch configurable running current, anti-resonance, input signal filter, step smoothing filter, and self test
- Motor selection via 16-bit rotary switch

SureStep advanced microstepping drives

(STP-DRV-4850, STP-DRV-80100, & STP-MTRD-xR)

All the features of the standard high-performance drive, plus:

- Software configurable
- 200 - 51,200 microsteps (software selectable)
- High-speed pulse input (Quadrature, cw/ccw, pulse/direction)
- Analog velocity mode (0-5v or potentiometer)
- Internal indexer (point-to-point moves via ASCII command)
- AB quadrature/encoder following for all advanced models
- Advanced "E" integrated models contain a built-in encoder (encoder is not accessible and not available for signaling outside the drive)

Power supplies

- SureStep linear power supplies, 32V @ 4A, 48V @ 5A, 48V @ 10A, 70V @ 5A
- Input and output fuses included on power supplies
- Includes 5 VDC Logic supply for all low voltage signals
- Switching power supplies also available (12V, 24V, 48V)



Choose your SureStep System

1. Choose a motor

Determine the torque and speed required by your application. Then look at the motor speed-torque curves in the Motors and Standard Integrated and Advanced Integrated sections of this catalog chapter, or the thrust-speed curves for Linear Actuators. Choose a standalone or integrated motor or linear actuator that can run your application with plenty of speed and torque/thrust reserve (most stepper systems should have a 100% safety margin for torque/thrust). If encoder feedback is desired, be sure to choose a "D" or "E" model motor, or "ADJ" model actuator. If an IP65 rating is desired, choose a "W" motor (no IP65 linear actuator models available at this time).

Note: If you chose an Integrated motor/drive, you can skip to "Choose a Power Supply". If you chose an STP-MTRAC-23xxx or -34xxx motor, you are done. These motors use the STP-DRVAC-24025 drive, have no motor extension cable (10' leads on the motor), and require no power supply (the drive uses AC input power).

Note: The STP-MTRAC-42xxx motors cannot use the [STP-DRVAC-24025](#) drive as it doesn't provide enough current.

NEMA 14, 17, 23, 34, and 42 mounting flanges

Variety of bipolar step motors to cover a wide range of applications

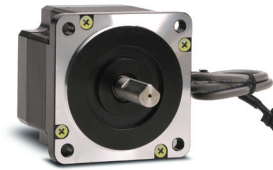

Holding torque ranges from 8 to 4532 oz-in

Single-shaft, Dual-shaft, IP65, high bus voltage, and encoder-mounted models available (Linear series does not have high bus voltage or IP65 models)

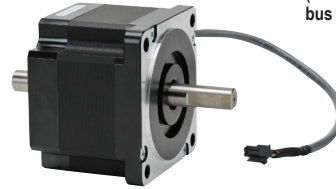

1-ft cable with locking connector on the end (not for linear actuators) (NEMA 23/34 MTRAC motors have 10' leads)

Square frame style produces high torque and achieves best torque-to-volume ratio

NEMA 17, 23 and 24 integrated motor/drives

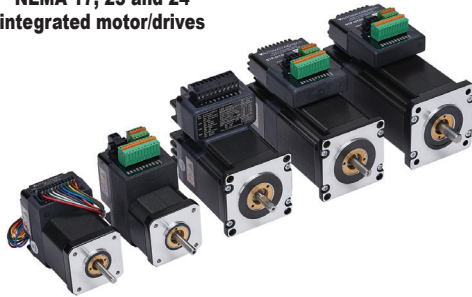

NEMA 17 and 23 linear actuators



NEMA 42 MTRAC(H)



2. Choose a motor extension cable

[If you chose an Integrated motor/drive in Step 1, skip to "Choose a Power Supply"; an extension cable is not required.]

Our 6-, 10-, and 20-ft motor extension cables have a locking connector that mates up to the motor cable. The extension cables allow you to quickly connect the motor to the drive without having to splice wires or cut any cables.

Note: All NEMA 23/34 STP-MTRAC-x motors have integrated 10-foot cables and don't need an extension cable.

20-foot extension cable with locking connector



SureStep Motor / Cable Compatibility	
Motor	Cable
STP-LE17 series linear actuator	STP-LA-EXT17-xx
STP-LE23 series linear actuator	STP-LA-EXT23-xx
STP-MTR-xxxx	STP-EXT-0xx
STP-MTR-xxxxW	STP-EXTW-0xx
STP-MTRAC-23xxx/34xxx	None
STP-MTRAC-42xxx	STP-EXT42-0xx
STP-MTRACH-42xxx	STP-EXT42H-0xx
STP-MTRH-xxxx	STP-EXTH-0xx
STP-MTRH-xxxxW	STP-EXTHW-0xx
STP-MTRL-xxxx	STP-EXTL-0xx

3. Choose a drive

Note: If you chose an Integrated motor/drive in Step 1, skip to "Choose a Power Supply" . . . you have already chosen your drive. If you chose STP-MTRAC-23xxx or STP-MTRAC-34xxx, you are done - these motors use the STP-DRVAC-24025 drive and don't require an extension cable or DC power supply.

Note: The STP-MTRAC-42xxx motors cannot use the STP-DRVAC-24025 drive as it doesn't provide enough current.

The chart below is a quick selection guide. For a full list of features, check out the Technical Info later in this chapter. The requirements for what you will need from a drive are determined by your applications. Deciding whether you plan to operate the drive via high-speed pulses, analog control, encoder following, or communication commands is an important factor. The voltage supplied to the drive as determined by the speed torque curves is another important factor to consider when choosing a drive. If you need to select a drive based on RMS step motor phase current, please see the next page.

- Standard and Advanced Drives and Integrated Motor/Drives can accept high-speed pulse input control.
- Advanced Drives and some Integrated Motor/Drives can also accept serial communication control.
- STP-MTRAC-23xxx and -34xxx and STP-DRVAC motors and drives are designed for use with high voltages. These components are not designed to work at low voltages (12V, 32V, 48V, 70V).

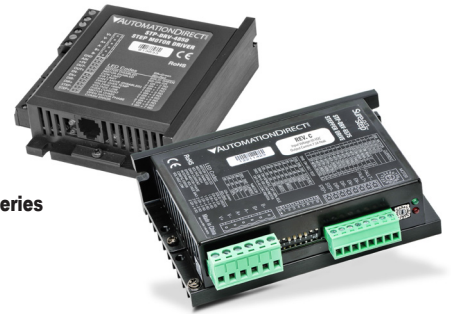

STP-DRV Series

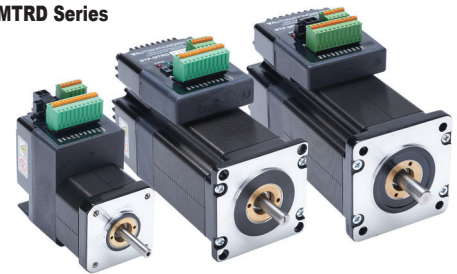

STP-MTRD Series

What you need	STP-DRV-4035	STP-DRV-4845	STP-DRV-4850	STP-DRV-6575	STP-DRV-80100	STP-MTRD-17x(E)	STP-MTRD-23x(E)	STP-MTRD-17xR(E)	STP-MTRD-23xR(E)	STP-MTRD-24xRV(E)
12V Speed-Torque Curve (from Step 1)	-	-	-	-	-	✓	✓	✓	✓	✓
32V Speed-Torque Curve (from Step 1)	✓	✓	✓	✓	✓	✓	✓	✓	✓	✓
48V Speed-Torque Curve (from Step 1)	-	✓	✓	✓	✓	-	✓	-	✓	✓
70V Speed-Torque Curve (from Step 1)	-	-	-	-	✓	-	✓	-	✓	✓
More than 3.5A/motor phase	-	✓	✓	✓	✓	-	-	-	-	-
More than 5A/motor phase ("H" motors)	-	-	-	✓	✓	-	-	-	-	-
Supply voltage	12-32	24-48	24-48	24-65	24-80	12-48	12-70	12-48	12-70	12-70
Digital Input Voltage	5V (12V*, 24V*)	5-24V	5V (12V*, 24V*)	5-24V	5V (12V*, 24V*)	5-24V	5-24V	5-24V	5-24V	5-24V
Internal Indexing (Drive can move from point A to point B with a serial communication command)	-	-	✓	-	✓	-	-	✓	✓	✓
High-speed pulse input	✓	✓	✓	✓	✓	✓	✓	✓	✓	✓
Analog Velocity input	-	-	✓	-	✓	-	-	✓	✓	✓
Position Verification (internal encoder)	-	-	-	-	-	-	-	E models only	E models only	E models only
External encoder	-	-	-	-	-	E models only	E models only	-	-	-
RS-232 communication (ASCII)	-	-	✓	-	✓	-	-	-	-	-
RS-485 communication (ASCII)	-	-	-	-	-	-	-	✓	✓	✓
Variable I/O (I/O can be either a digital input or digital output)	-	-	-	-	-	-	-	-	-	✓

* External dropping resistor required for 12V and 24V I/O use. See Product Data Sheet for wiring details and resistor values.



Choose your SureStep System

3a. Using RMS Step Motor Phase Current to Select an Appropriate Stepper Drive Rated in Peak Phase Current

$$(\text{Drive Amps})_{\text{peak}} = 1.2 \times (\text{Motor Amps})_{\text{RMS}}$$

Generic stepper drives usually have output current specified in peak phase current while stepper motors will have their phase current specified in RMS phase current. This can cause sub-optimal drive to motor pairing unless this is understood. There is no need to understand this difference if you are selecting a system that uses the SureStep drives that are tuned for specific SureStep motors. These drives will have a rotary switch setting (STP-DRV-6575 and STP-DRVAC-24025) or a motor selection in the SureMotion Pro software (STP-DRV-4850 and STP-DRV-80100). These drives when properly paired with a SureStep motor will output 1.2 times the motor rated phase current.

When choosing a drive that only has current selections instead of motor specific selections you will want to select a peak current that is 1.2 times the motor's listed RMS current. The true peak drive current value would be 1.4 times the RMS motor value but this amount of current will cause a lot of motor heating and the torque at higher speeds will actually suffer with due to higher back electro-magnetic force caused by the inductive field of the coils changing polarity quickly.

Example of a SureStep matched stepper system

To use an STP-MTR-23055 motor with a STP-DRV-6575 drive, the drive's rotary switch should be positioned to selection 9 (STP-MTR-23055x). The STP-MTR-23055 has a phase current of 2.8 A (RMS), so the drive will actually output $1.2 \times 2.8 \text{ A (RMS)} = 3.36 \text{ A (peak)}$. You do not need to calculate peak or RMS current with a pre-configured SureStep motor and drive system.

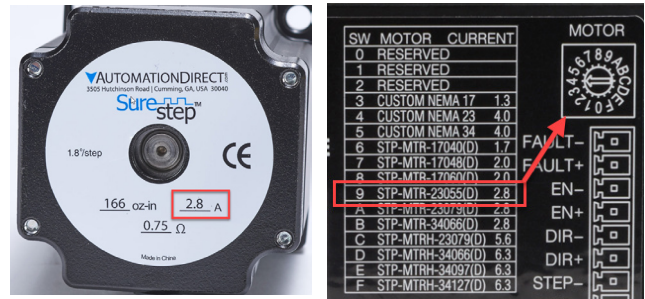

Matched stepper system

Example of an adjustable current stepper drive

To use an STP-MTR-23055 motor with a STP-DRV-4845 drive, you should calculate the correct phase current setting for the drive. The motor phase current is 2.8 A (RMS).

- If you do not understand peak vs RMS current, you would select phase current position #8, the 2.8 A selection on the drive (blue box). This setting will work (and the motor will run very cool) but will provide slightly less than the motor's rated torque.
- If a true peak current value is selected ($1.4 \times 2.8 \text{ A} = 3.92 \text{ A}$) then the rotary switch selection would be set to the C position (red box). This will cause excessive motor heating and a lack of performance at higher speeds.
- The optimal phase current selection for stepper motors is 1.2 times the motor RMS phase current ($1.2 \times 2.8 \text{ A (RMS)} = 3.36 \text{ A (peak)}$). This will be the rotary switch selection A (green box)

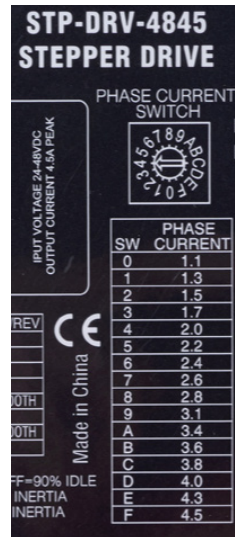

Rotary Switch Position	SW1 & SW2 @100%	SW1 & SW2 @90%	SW1 & SW2 @80%
0	1.1	1.0	0.9
1	1.3	1.2	1.0
2	1.5	1.4	1.2
3	1.7	1.5	1.4
4	2.0	1.8	1.6
5	2.2	2.0	1.8
6	2.4	2.2	1.9
7	2.6	2.3	2.1
8	2.8	2.5	2.2
9	3.1	2.8	2.5
A	3.4	3.1	2.7
B	3.6	3.2	2.9
C	3.8	3.4	3.0
D	4.0	3.6	3.2
E	4.3	3.9	3.4
F	4.5	4.1	3.6

Matching an adjustable stepper drive with any step motor



Choose your SureStep System

4. Choose a power supply

Since all low voltage SureStep (non-integrated) motors can operate at 32V, 48V, and 70V, the selection of a power supply is dependent on the selected speed-torque curve of the motor and on the selection of drive. If using an integrated motor/drive, then the power supply is dictated by the specifications of the integrated product. If using an STP-MTRAC-23xxx or -34xxx drive, no DC power supply is needed since the drive is powered directly from 115 to 230 VAC. Choose a power supply that matches the desired speed-

torque curve and stays within the voltage limit of the selected drive. Each SureStep linear power supply has incoming AC and outgoing DC fusing. The linear supplies have an electronic overload protected 5V supply for all your logic needs. Stepper applications without large fluctuations in load, without aggressive deceleration, and without regeneration (where the load pushes the motor) can often use a switching power supply instead.

Permissible Drive/Power Supply Combinations

DC Powered Drive	Linear Power Supply				Switching Power Supply		
	<i>STP-PWR-3204</i>	<i>STP-PWR-4805</i>	<i>STP-PWR-4810</i>	<i>STP-PWR-7005</i>	<i>PSB12-xxxS</i>	<i>PSB24-xxxS</i>	<i>PSB48-xxxS</i>
STP-DRV-4830 12-48 VDC input (53V max)	√	√	√	-	√	√	√
STP-DRV-4845 24-48 VDC input (60V max)	√	√	√	-	-	√	√
STP-DRV-4850 24-48 VDC input (53V max)	√	√	√	-	-	√	√
STP-DRV-6575 24-65 VDC input (85V max)	√	√	√	-	-	√	√
STP-DRV-80100 24-80 VDC input (88V max)	√	√	√	√	-	√	√
STP-MTRD-17 series 12-48 VDC input (55V max)	√	√	√	-	√	√	√
STP-MTRD-23, -24 series 12-70 VDC input (75V max)	√	√	√	√	√	√	√
Supply current calculation	For systems that use multiple steppers and only one power supply, the power supply current must be at least the sum of 2/3rds of the combined motor currents: $I(ps) \geq 2/3 \times (I_{motor1} + I_{motor2} + I_{motor3} + \dots)$						

Linear Power Supply

120 or 240 VAC, 50/60 Hz power input (switch selectable)

Screw terminal AC input and DC output connections

32V, 48V and 70V linear supplies

Power ON LEDs

unregulated linear supplies perfect for stepper systems

Input and output fusing included



5 VDC ±5% at 500 mA regulated logic power

Switching Power Supply

85-264 VAC (DC input range 120-375 VDC)

Rugged plastic or aluminum housings with integral 35mm DIN rail mounting adapters

Adjustable output voltage



Output voltage status LED

DC Output Overload and Short-Circuit Protected

Note: For detailed information on the switching power supplies, please see: <https://cdn.automationdirect.com/static/specs/rhinopsbc1d2.pdf>



Stepping System Components

SureStep® System



Step Motor Power Supply

or



Step Motor Power Supply

Standard or Advanced
Microstepping Drive

Extension Cable

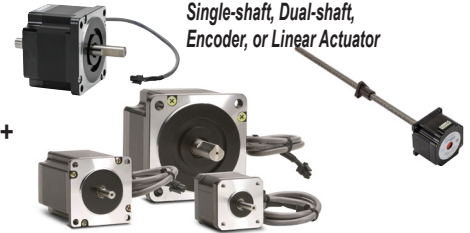

Connectorized Step Motor

or

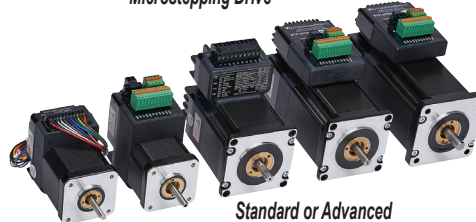
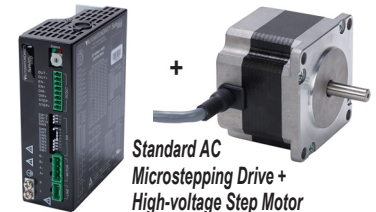
Standard or Advanced
Integrated Motor/DriveStandard AC
Microstepping Drive +
High-voltage Step Motor

SureStep stepping family includes:

- Linear step motor power supplies
- DIP-switch configurable microstepping drives
- Software-configurable advanced microstepping drives
- Motor extension cables
- NEMA 14, 17, 23, 24, 34, and 42 frame size step motors in single shaft, dual-shaft, IP65, high bus voltage, or encoder mounted configurations
- NEMA 17, 23, and 24 frame size integrated motor/drives
- NEMA 17 and 23 linear actuators (6", 9", and 12" lengths)
- Variety of step motor accessories including encoders, control cables, and connector kits
- SureStep PC adapter, USB to RS-485
- SureMotion Pro software for advanced drive and integrated motor/drive systems

Motor features

- Low voltage, high torque, 2-phase, bipolar, 1.8° per step, 4-lead
- High voltage, high torque, 2-phase, bipolar, 1.8° per step, 8-lead
- Available in single-shaft and dual-shaft models
- Connectorized pigtailed or integrated 10' cable (STP-MTRAC only)
- Optional encoder feedback (STP-MTR-xxxxE)
- IP65 versions available (STP-MTR-xxxxW)
- High bus voltage versions available (STP-MTRAC-xxxx)
- Linear actuators have lead screws for motor shafts (STP-LExx-xxxxxx)
- Linear actuators ADJ series available with encoder-ready rear shaft and machined journals on screw ends for easy bearing mounting
- Wide variety of NEMA 14, 17, 23, and 34 motors

Power supply features

- Linear, unregulated DC power supplies
- 120/240 VAC selectable input
- 32V, 48V, 70V DC output models available
- All linear models have additional 5VDC, 500mA regulated logic supply
- Fusing included for both incoming AC and outgoing DC
- 5V supply has electronic overload protection

NOTE: If a switching power supply is desired, we recommend the PSB12-xxxS, PSB24-xxxS, or PSB48-xxxS series.

Standard stepper drive features

(STP-DRV-4035, -4830, -4845, -6575, STP-MTRD-x, STP-DRVAC-24025)

- Low cost, digital step motor driver in compact package
- Operates from Step and Direction signals, or Step CW and Step CCW (jumper selectable).
- Fault output and Enable input
- Optically isolated I/O
- Digital filters prevent position error from electrical noise on command signals; jumper selectable: 150 kHz or 2MHz
- Rotary or DIP switch easily selects from many popular motors
- Electronic damping and anti-resonance
- Automatic idle current reduction to reduce heat when motor is not moving; switch selectable: 50% or 90% of running current
- Switch-selectable step resolution: 200–25,600 steps per revolution depending on drive
- Switch-selectable microstep emulation provides smoother, more reliable motion in full- and half-step modes
- Automatic self test (switch selectable)
- Optional external encoder feedback (integrated models)
- Operates from a 24–65 VDC or 12–40 VDC power supply, depending upon model. STP-DRVAC drive operates off AC voltage.
- Running current from 0.35–7.5A

Advanced stepper drive features

(STP-DRV-4850, STP-DRV-80100, STP-MTRD-xR, & STP-MTRD-xRE)

- Max 5A, 48V and max 10A, 80V models available
- Software configurable
- Programmable microsteps
- Internal indexer (via ASCII commands)
- Self test feature
- Idle current reduction
- Anti-resonance
- Torque ripple smoothing
- Step, analog, and serial communication inputs
- Serial communications allow point-to-point positioning
- AB quadrature/encoder following (integrated models)
- Optional internal encoder feedback (integrated models)
- RS-485 communications (integrated models)
- Four 5 to 24 volt digital "Variable I/O" points (NEMA 24 integrated models)
- Controllable via streaming SCL commands



Stepping System Components

SureStep Power Supply / DC Input Drive Compatibility				
Drive(1)(2)	Recommended Linear Power Supply(1)(2)(5)			
Model #	STP-PWR-3204	STP-PWR-4805	STP-PWR-4810	STP-PWR-7005(3)
STP-DRV-4035	✓	No	No	No
STP-DRV-4830	✓	✓	✓	No
STP-DRV-4845	✓	✓	✓	No
STP-DRV-4850	✓	✓	✓	No
STP-DRV-6575	✓	✓	✓	No
STP-DRV-80100	✓	✓	✓	✓
STP-MTRD-17(4)	✓	✓	✓	No
STP-MTRD-23(4)	✓	✓	✓	✓
STP-MTRD-24(4)	✓	✓	✓	✓

1) Do NOT use a power supply that exceeds the drive's input voltage range.
If using a linear power supply, ensure that the unloaded voltage does not float above the drive's maximum input range.
2) For best performance, use the lowest voltage power supply that supplies the required speed and torque.
3) An unloaded STP-PWR-7005 can float above the allowable input voltages of some drives if it is fed with a high AC input voltage (greater than 120VAC).
4) Integrated motor/drives are included here because they include a drive as well as a motor.
5) STP-DRVAC-x drives are AC powered and cannot be powered by DC power supplies.

SureStep Power Supply / DC Input Drive Compatibility			
Drive(1)(2)	Recommended Switching Power Supply(1)(2)(4)		
Model #	PSB12-xxxS	PSB24-xxxS	PSB48-xxxS
STP-DRV-4035	✓	✓	No
STP-DRV-4830	✓	✓	✓
STP-DRV-4845	No	✓	✓
STP-DRV-4850	No	✓	✓
STP-DRV-6575	No	✓	✓
STP-DRV-80100	No	✓	✓
STP-MTRD-17(3)	✓	✓	✓
STP-MTRD-23(3)	✓	✓	✓
STP-MTRD-24(3)	✓	✓	✓

1) Do NOT use a power supply that exceeds the drive's input voltage range.
2) For best performance, use the lowest voltage power supply that supplies the required speed and torque.
3) Integrated motor/drives are included here because they include a drive as well as a motor.
4) STP-DRVAC-x drives are AC powered and cannot be powered by DC power supplies.

SureStep AC Motor/Drive Compatibility		
Model #	STP-DRVAC-24025	
	Series Wired Motor	Parallel Wired Motor
STP-MTRAC-23044(x)	✓	No
STP-MTRAC-23055(x)	✓	No
STP-MTRAC-23078(x)	✓	No
STP-MTRAC-34075(x)	✓	No
STP-MTRAC-34115(x)	✓	No
STP-MTRAC-34156(x)	✓	No

NOTE: STP-MTRAC-34156(x) motors have a 5/8" front shaft.

SureStep DC Input Drive / Motor Compatibility(3)								
Model # (1)	Rated Amps(2)	Extension Cable	Recommended Drive(1)					
			STP-DRV-4035(1)	STP-DRV-4830	STP-DRV-4845	STP-DRV-4850(1)	STP-DRV-6575(1)	STP-DRV-80100(1)
STP-MTRL-14026(x)	0.35	STP-EXTL-0xx	✓	✓	-	✓	-	-
STP-MTRL-14034(x)	0.8	STP-EXTL-0xx	✓	✓	✓	✓	-	-
STP-MTR-17040(x)	1.7	STP-EXTL-0xx	✓	✓	✓	✓	✓	✓
STP-MTR-17048(x)	2.0	STP-EXTL-0xx	✓	✓	✓	✓	✓	✓
STP-MTR-17060(x)	2.0	STP-EXTL-0xx	✓	✓	✓	✓	✓	✓
STP-MTR-23055(x)	2.8	STP-EXTL-0xx	✓	✓	✓	✓	✓	✓
STP-MTR-23079(x)	2.8	STP-EXTL-0xx	✓	✓	✓	✓	✓	✓
STP-MTR-34066(x)	2.8	STP-EXTL-0xx	✓	✓	✓	✓	✓	✓
STP-MTRAC-42100(x)	4.2	STP-EXT420xx	-	-	✓	✓	✓	✓
STP-MTRAC-42151(x)	6	STP-EXT420xx	-	-	-	-	✓	✓
STP-MTRAC-42202(x)	6	STP-EXT420xx	-	-	-	-	✓	✓
STP-MTRH-23079(x)	5.6	STP-EXTH-0xx	-	-	-	-	✓	✓
STP-MTRH-34066(x)	6.3	STP-EXTH-0xx	-	-	-	-	✓	✓
STP-MTRH-34097(x)	6.3	STP-EXTH-0xx	-	-	-	-	✓	✓
STP-MTRH-34127(x)	6.3	STP-EXTH-0xx	-	-	-	-	✓	✓
STP-MTRACH-42100(x)	6	STP-EXT420xx	-	-	-	-	✓	✓
STP-MTRACH-42151(x)	8	STP-EXT420xx	-	-	-	-	-	✓
STP-MTRACH-42202(x)	8	STP-EXT420xx	-	-	-	-	-	✓

1) The combinations above will perform according to the published speed/torque curves. Using a motor with a current rating higher than the drive's output rating will proportionally limit the motor torque.
2) Listed NEMA42 motor amperages are for Bipolar Series wiring. See the NEMA42 motor specs for amperages with other wiring types.
3) Table not applicable to integrated motor/drives as drives and motors are already paired.

Typical Wiring Diagram

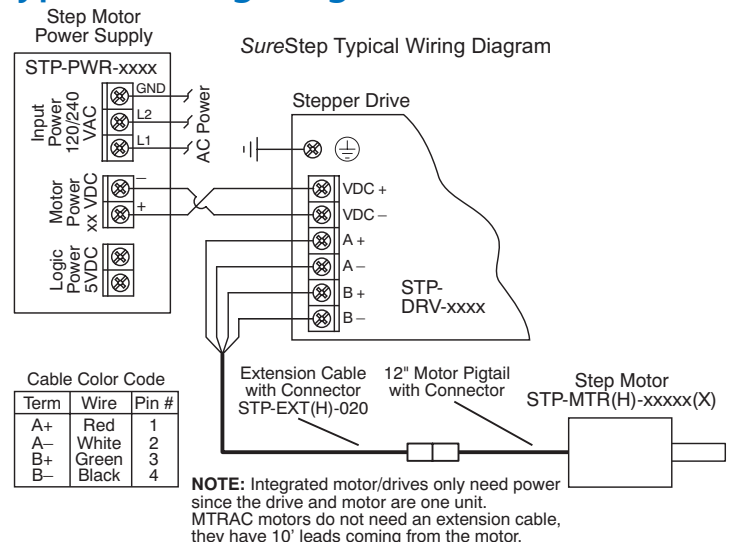

NOTE: STP-MTRAC-23xxx/34xxx motors and STP-DRVAC drives are designed to work with AC input power to the drive. They are not designed to work with DC input power.



Stepping System Drives

SureStep Series – Microstepping Drives Features Comparison											
Drive Model	Standard Microstepping Drives						Advanced Microstepping Drives				
	STP-DRVAC-24025	STP-DRV-4830	STP-DRV-4845	STP-DRV-6575	STP-MTRD-x	STP-DRV-4035	STP-DRV-4850	STP-DRV-80100	STP-MTRD-xR		
Price	\$222.00	\$77.00	\$93.00	\$107.00	See Integrated Motor/Drives section	Retired	\$278.00	\$332.00	See Integrated Motor/Drives section		
Drive Type	Microstepping drive with pulse input				Integrated stepper motor/drive	Micro-stepping drive with pulse input	Advanced microstepping drive with pulse or analog input, serial communication; includes programming/communication cable STP-232RJ11-CBL		Advanced integrated stepper motor/drive with internal encoder		
	enclosed				enclosed	open-frame	enclosed		enclosed		
Output Current	0.6–2.5 A/phase	0.35–3.0 A/phase	0.8–4.5 A/phase	1.0–7.5 A/phase	–	0.4–3.5 A/phase	0.1–5 A/phase	0.1–10 A/phase	–		
Input Voltage	nominal: 120/240 VAC range: 90–240 VAC	nominal: 12–48 VDC range: 10–53 VDC	nominal: 24–48 VDC range: 20–60 VDC	nominal: 24–75 VDC range: 20–85 VDC	nominal: 12–48 VDC (NEMA 17) 12–70 VDC (NEMA 23) range: 10–55 VDC (NEMA 17) 11–74 VDC (NEMA 23)	nominal: 12–32 VDC range: 12–42 VDC	nominal: 24–48 VDC range: 18–53 VDC	nominal: 24–80 VDC range: 18–88 VDC	nominal: 12–48 VDC (NEMA 17) 12–70 VDC (NEMA 23, 24) range: 10–55 VDC (NEMA 17) 11–74 VDC (NEMA 23) 10–75 VDC (NEMA 24)		
Configuration Method	rotary dial, dip switches, jumpers				dip switches		SureMotion Pro software (SM-PRO : free download)				
Amplifier Type	MOSFET, dual H-bridge, 4-quadrant				Dual H-bridge, 4 quadrant	MOSFET, dual H-bridge, bipolar chopper	MOSFET, dual H-bridge, 4-quadrant		Dual H-bridge, 4 quadrant		
Current Control	4-state PWM @ 20 kHz	4-state PWM @ 16 kHz	4-state PWM @ 20 kHz		4-state PWM @ 16 kHz	4-state PWM @ 20 kHz					
Microstep Resolution	dipswitch selectable						software selectable				
	200 to 25,600 steps/rev		200 to 20,000 steps/rev		200 to 25,600 steps/rev	400 to 10,000 steps/rev	200 to 51200 steps/rev				
Modes of Operation	Step & Dir	YES	YES	YES	YES	YES	YES	YES	YES	YES	
	CW/CCW	YES	YES	YES	YES	YES	n/a	YES	YES	YES	
	A/B Quad	n/a	n/a	n/a	n/a	n/a	n/a	YES	YES	YES	
	Oscillator	n/a	n/a	n/a	n/a	n/a	n/a	YES	YES	YES	
	Serial Indexing	n/a	n/a	n/a	n/a	n/a	n/a	YES	YES	YES	
Digital Input Signals	Step/Pulse	step & direction, CW/CCW step				step & direction, CW/CCW step	step & direction	step & direction, CW/CCW step, A/B quadrature, run/stop & direction, jog CW/CCW, CW/CCW limits			
	Direction										
	Enable	motor disable				motor enable	motor disable	motor enable, alarm reset, speed select (oscillator mode)			
Analog Input	n/a	n/a	n/a	n/a	n/a	n/a	speed control		signal range, offset, dead band, and filtering		
Output Signal	fault	n/a	fault	fault	fault	n/a	fault, motion, tach		brake, fault, motion, tach		
Communication Interface	n/a	n/a	n/a	n/a	n/a	n/a	YES (programming/communication cable included)				
Non-volatile Memory Storage	n/a	n/a	n/a	n/a	n/a	n/a	YES				
Idle Current Reduction	YES										
Self Test	YES										
Additional Features	Step pulse noise filter, accepts AC power input	Step pulse noise filter	Load inertia (anti-resonance & damping feature to improve motor performance) Step pulse noise filter			n/a	Anti-resonance (Electronic Damping) Auto setup Microstep emulation Torque ripple smoothing (allows for fine adjustment of phase in the range 0.25 to 1.5 rps) Waveform (command signal) smoothing				

Refer to Specifications Tables for detailed specifications.

Stepping System Motors

SureStep® Stepping Motors

SureStep Series Part Numbers – Bipolar Stepping Motors*					
Bipolar Stepping Motors	Price	Shaft Type	Torque Level	Encoder Mounting	Drawing
STP-MTRL-14026	\$25.00	single	low	not available	PDF
STP-MTRL-14026D	\$29.50	dual		optional	PDF
STP-MTRL-14026E**	\$107.00	dual		pre-installed	PDF
STP-MTRL-14034	\$31.00	single		not available	PDF
STP-MTRL-14034D	\$36.50	dual		optional	PDF
STP-MTRL-14034E**	\$111.00	dual		pre-installed	PDF
STP-MTR-17040	\$22.50	single	high	not available	PDF
STP-MTR-17040D	\$26.50	dual		optional	PDF
STP-MTR-17040E**	\$103.00	dual		pre-installed	PDF
STP-MTR-17040W***	\$146.00	single		not available	PDF
STP-MTR-17048	\$26.50	single		not available	PDF
STP-MTR-17048D	\$31.00	dual		optional	PDF
STP-MTR-17048E**	\$108.00	dual		pre-installed	PDF
STP-MTR-17048W***	\$150.00	single		not available	PDF
STP-MTR-17060	\$43.00	single		not available	PDF
STP-MTR-17060D	\$48.50	dual		optional	PDF
STP-MTR-17060E**	\$125.00	dual		pre-installed	PDF
STP-MTR-17060W***	\$193.00	single		not available	PDF
STP-MTR-23055	\$42.50	single		not available	PDF
STP-MTR-23055D	\$48.50	dual		optional	PDF
STP-MTR-23055E**	\$126.00	dual	pre-installed	PDF	
STP-MTR-23055W***	\$181.00	single	not available	PDF	
STP-MTR-23079	\$55.00	single	not available	PDF	
STP-MTR-23079D	\$60.00	dual	optional	PDF	
STP-MTR-23079E**	\$137.00	dual	pre-installed	PDF	
STP-MTR-23079W***	\$196.00	single	not available	PDF	
STP-MTR-34066	\$129.00	single	high	not available	PDF
STP-MTR-34066D	\$146.00	dual		optional	PDF
STP-MTR-34066W***	\$234.00	single		not available	PDF
STP-MTRH-23079	\$61.00	single		not available	PDF
STP-MTRH-23079D	\$66.00	dual		optional	PDF
STP-MTRH-23079E**	\$144.00	dual		pre-installed	PDF
STP-MTRH-23079W***	\$291.00	single		not available	PDF
STP-MTRH-34066	\$144.00	single		not available	PDF
STP-MTRH-34066D	\$160.00	dual		optional	PDF
STP-MTRH-34066W***	\$331.00	single		not available	PDF
STP-MTRH-34097	\$163.00	single		not available	PDF
STP-MTRH-34097D	\$180.00	dual		optional	PDF
STP-MTRH-34097W***	\$371.00	single		not available	PDF
STP-MTRH-34127	\$192.00	single		not available	PDF
STP-MTRH-34127D	\$212.00	dual	optional	PDF	
STP-MTRH-34127W***	\$406.00	single	not available	PDF	

* For integrated motor/drives part numbers and pricing, see the integrated motor/drives section.

** E model motors come with an AMT112Q-V encoder pre-installed. Requires STP-CBL-EBxx for encoder wiring. To change from the default 400ppr, use AMT-PGRM-17C. See the SureStep Stepping System Encoders section for more details.

*** W models are IP65 washdown rated. All others are IP40.

STP-MTR-xxxxx
(single-shaft)

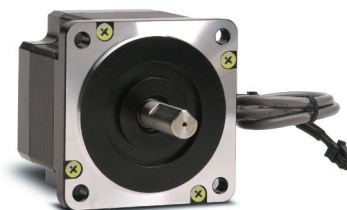

STP-MTR-xxxxxE
(encoder mount)



STP-MTR-xxxxxD
(dual-shaft)

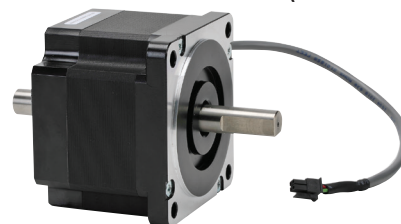

STP-MTR-xxxxxW
(IP65)





Stepping System Motors

SureStep® Stepping Motors

SureStep Series Part Numbers – Bipolar Stepping Motors, <i>continued</i>					
Bipolar Stepping Motors	Price	Shaft Type	Torque Level	Encoder Mounting	Drawing
<i>Motors listing continued from previous page</i>					
STP-MTRAC-23044	\$63.00	single	High voltage High torque	not available	PDF
STP-MTRAC-23044D	\$64.00	dual		optional	PDF
STP-MTRAC-23055	\$71.00	single		not available	PDF
STP-MTRAC-23055D	\$72.00	dual		optional	PDF
STP-MTRAC-23078	\$99.00	single		not available	PDF
STP-MTRAC-23078D	\$100.00	dual		optional	PDF
STP-MTRAC-34075	\$265.00	single		not available	PDF
STP-MTRAC-34075D	\$265.00	dual		optional	PDF
STP-MTRAC-34115	\$274.00	single		not available	PDF
STP-MTRAC-34115D	\$275.00	dual		optional	PDF
STP-MTRAC-34156	\$295.00	single*	not available	PDF	
STP-MTRAC-34156D	\$295.00	dual*	optional	PDF	
STP-MTRAC-42100	\$244.00	single	High voltage Higher torque	not available	PDF
STP-MTRAC-42100D	\$265.00	dual		optional**	PDF
STP-MTRAC-42151	\$409.00	single		not available	PDF
STP-MTRAC-42151D	\$430.00	dual		optional**	PDF
STP-MTRAC-42202	\$501.00	single		not available	PDF
STP-MTRAC-42202D	\$519.00	dual		optional**	PDF
STP-MTRACH-42100	\$244.00	single		not available	PDF
STP-MTRACH-42100D	\$265.00	dual		optional**	PDF
STP-MTRACH-42151	\$409.00	single		not available	PDF
STP-MTRACH-42151D	\$430.00	dual		optional**	PDF
STP-MTRACH-42202	\$501.00	single	not available	PDF	
STP-MTRACH-42202D	\$519.00	dual	optional**	PDF	

* NOTE: STP-MTRAC-34156(x) motors have a 5/8" front shaft.

** NOTE: NEMA 42 "D" motors require an [STP-MTRA-42ENC](#) adapter plate for AMT13/AMT33 encoder mounting.

STP-MTRAC-xxxxx
(single-shaft)



STP-MTRAC-xxxxxD
(dual-shaft)



STP-MTRACH-42xxxD
(dual-shaft)



SureStep® Stepping Motors Mounting Accessories

Mounting Accessories – for NEMA 17 and NEMA 42 SureStep Stepping Motors				
Part Number	Price	Description	Drawing Links	Use With
STP-MTRA-RB-85	\$9.25	Reducer bushing, 8mm OD to 5mm ID, 16mm length, aluminum alloy. Connects NEMA size 17 stepper motors to Koyo TRD-NH and TRD-SH hollow shaft encoders.	n/a	SureStep NEMA 17 motors
STP-MTRA-42ENC	\$9.25	SureStep encoder mounting plate, metal body. For use with SureStep NEMA 42 stepper motors with dual shafts. Encoder mounting screws and mounting plate screws included. Mounting holes for CUI Devices AMT132/AMT332 encoders and US Digital E6 encoders.	PDF	SureStep NEMA 42 motors

STP-MTRA-42ENC





Stepping System Motors

SureStep® Stepping Motors

SureStep Series Specifications – Connectorized Bipolar Stepping Motors													
Bipolar Stepping Motors	Low Voltage Low Torque		Low Voltage High Torque					Low Voltage Higher Torque					
	STP-MTRL-14026(x)	STP-MTRL-14034(x)	STP-MTR-17040(x)	STP-MTR-17048(x)	STP-MTR-17060(x)	STP-MTR-23055(x)	STP-MTR-23079(x)	STP-MTR-34066(x)	STP-MTRH-23079(x)	STP-MTRH-34066(x)	STP-MTRH-34097(x)	STP-MTRH-34127(x)	
NEMA Frame Size	14	14	17	17	17	23	23	34	23	34	34	34	
Maximum Holding Torque*	(lb·in)	0.5	1.25	3.81	5.19	7.19	10.37	17.25	27.12	17.87	27.12	50.00	80.50
	(oz·in)	8	20	61	83	115	166	276	434	286	434	800	1288
	(N·m)	0.06	0.14	0.43	0.59	0.81	1.17	1.95	3.06	2.02	3.06	5.65	9.10
Rotor Inertia	(oz·in ²)	0.06	0.08	0.28	0.37	0.56	1.46	2.60	7.66	2.60	7.66	14.80	21.90
	(kg·cm ²)	0.0003	0.00035	0.05	0.07	0.10	0.27	0.48	1.40	0.48	1.40	2.71	4.01
Rated Current (A/phase)	0.35	0.8	1.7	2.0	2.0	2.8	2.8	2.8	5.6	6.3	6.3	6.3	
Resistance (Ω/phase)	8.5	7.66	1.6	1.4	2.0	0.75	1.1	1.11	0.4	0.25	0.3	0.49	
Inductance (mH/phase)	5.77	6.92	3.0	2.7	3.3	2.4	3.8	6.6	1.2	1.5	2.1	4.1	
Insulation Class	130°C [266°F] Class B; 300V rms												
Basic Step Angle	1.8°												
Shaft Runout (in)	0.002 in [0.051 mm]												
Max Shaft Radial Play @ 1lb load	0.001 in [0.025 mm]												
Perpendicularity	0.003 in [0.076 mm]												
Concentricity	0.003 in [0.076 mm]												
Maximum Radial Load (lb [kg])*	6.0 [2.7]				15.0 [6.8]			39.0 [17.7]	15.0 [6.8]	39.0 [17.7]			
Maximum Thrust Load (lb [kg])*	6.0 [2.7]				13.0 [5.9]			25.0 [11.3]	13.0 [5.9]	25.0 [11.3]			
Storage Temperature Range	-20°C to 100°C [-4°F to 212°F]												
Operating Temperature Range	-20°C to 50°C [-4°F to 122°F] (motor case temperature should be kept below 80°C [176°F])												
Operating Humidity Range	55% to 85% non-condensing												
Product Material	steel motor case; stainless steel shaft(s)												
Environmental Rating	IP40 (IP65 for "W" motors)												
Weight (lb [kg]) (E models)	0.25 [0.11] (0.3 [0.1])	0.35 [0.15] (0.4 [0.2])	0.6 [0.3] (0.7 [0.3])	0.7 [0.3] (0.8 [0.4])	0.9 [0.4] (0.9 [0.4])	1.5 [0.7] (1.5 [0.7])	2.2 [1.0] (2.4 [1.1])	3.9 [1.7]	2.4 [1.1] (2.4 [1.1])	3.9 [1.7]	5.9 [2.7]	8.4 [3.8]	
Agency Approvals	CE												
Design Tips	<p>Allow sufficient time to accelerate the load and size the step motor with a 100% torque safety factor. DO NOT disassemble step motors because motor performance will be reduced and the warranty will be voided. DO NOT connect or disconnect the step motor during operation.</p> <p>Mount the motor to a surface with good thermal conductivity, such as steel or aluminum, to allow heat dissipation. Use a flexible coupling with "clamp-on" connections to both the motor shaft and the load shaft to prevent radial and thrust loading on bearings from minor misalignment.</p>												
Accessory Extension Cable	STP-EXTL-0xx		STP-EXT-0xx STP-EXTW-0xx (for "W" motors)					STP-EXTH-0xx STP-EXTHW-0xx (for "W" motors)					

* For dual-shaft motors (STP-MTR-xxxxD):

The sum of the front and rear Torque Loads, Radial Loads, and Thrust Loads must not exceed the applicable Torque, Radial, and Thrust load ratings of the motor.



Stepping System Power Supplies

SureStep® Power Supplies

SureStep Series Specifications – Stepping System Power Supplies				
Power Supply	STP-PWR-3204	STP-PWR-4805	STP-PWR-4810	STP-PWR-7005
Drawing	PDF	PDF	PDF	PDF
Price	\$150.00	\$183.00	\$237.00	\$233.00
Input Power (fuse protected *)	1-phase, 120/240 VAC, 50/60 Hz, 150 VA Fuse*: 3A	1-phase, 120/240 VAC, 50/60 Hz, 350 VA Fuse*: 5A	1-phase, 120/240 VAC, 50/60 Hz, 650 VA Fuse*: 8A	1-phase, 120/240 VAC, 50/60 Hz, 500 VA Fuse*: 7A
Input Voltage Range (switch selectable)	120/240 VAC ±10% (Voltage range switch is set to 240 VAC from factory)			
Inrush Current	120 VAC < 12 A / 240 VAC < 14 A	120 VAC < 20A / 240 VAC < 24A	120 VAC < 40A / 240 VAC < 50A	
Motor Supply Output (linear unregulated, fuse protected *, and power on LED indicator)	32 VDC @ 4A (fully loaded) 35 VDC @ 1A load 41 VDC @ no load Fuse*: 6A (Electrically isolated from Logic Supply Output)	46.5 VDC @ 5A (fully loaded) 52 VDC @ 1A load 57.5 VDC @ no load Fuse*: 8A	46.5 VDC @ 10A (fully loaded) 50 VDC @ 1A load 57.5 VDC @ no load Fuse*: 15A	70 VDC @ 5A (fully loaded) 79 VDC @ 1A load 86.5 VDC @ no load Fuse*: 8A
Logic Supply Output (regulated and power on LED indicator)	5 VDC ±5% @ 500 mA (Electronically Overload Protected) (Electrically isolated from Motor Supply Output)			
Watt Loss	13W	25W	51W	42W
Storage Temperature Range	-55 to 85 °C [-67 to 185 °F]			
Operating Temperature Range	0 to 50 °C [32 to 122 °F] full rated; derate current 1.1% per degree above 50°C; 70 °C [158 °F] maximum			
Humidity	95% (non-condensing) relative humidity maximum			
Cooling Method	Natural convection (mount power supply to metal surface if possible)			
Mounting	Mount on either wide or narrow side with machine screws per dimension diagrams			
Weight (lb [kg])	6.5 [2.9]	11 [4.9]	18 [8.3]	16 [7.2]
Connections	Screw Terminals			
Agency Approvals	UL (file # E181899), CSA, CE			

* Fuses to be replaced by qualified service personnel only. Use (1-1/4 x 1/4 in) ceramic fast-acting fuses (Edison type ABC from AutomationDirect, or equivalent).

Power Supply Dimensions

STP-PWR-3204 Power Supply

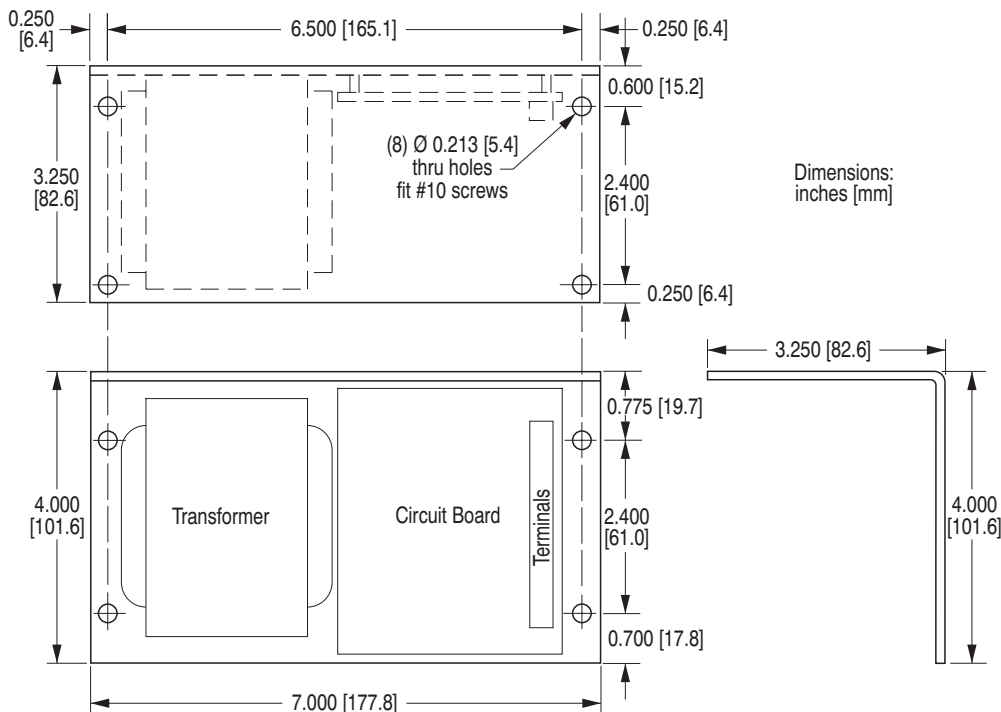



Integrated Microstepping Motors and Drives

SureStep® Integrated Motors System

General integrated motor/drive features

- DC power supply required (12-48 VDC or 12-70 VDC)
- Pulse/Direction or CW Pulse/CCW Pulse
- Digital input filtering
- "E" models include an encoder
- Three optically isolated digital inputs, 5 to 24 volts
- Step input signal smoothing (microstep emulation), performs high resolution stepping by synthesizing coarse steps into fine microsteps
- Dynamic smoothing, software-configurable filtering for use in removing spectral components from command sequence, reduces jerk, limiting excitation of system resonance
- Anti-resonance (electronic damping): raises the system-damping ratio to eliminate midrange instability and allow stable operation throughout the speed range of the motor
- Idle current reduction range of 0-90% of running current after a delay selectable in milliseconds (Standard models = 50/90%, DIP switch selectable)
- Configurable hardware digital noise filter, software noise filter
- Non-volatile storage, configurations are saved in FLASH memory on-board the DSP
- Dynamic current control, software configurable for running current, accel current, idle current, to make motion smoother and the motor run cooler

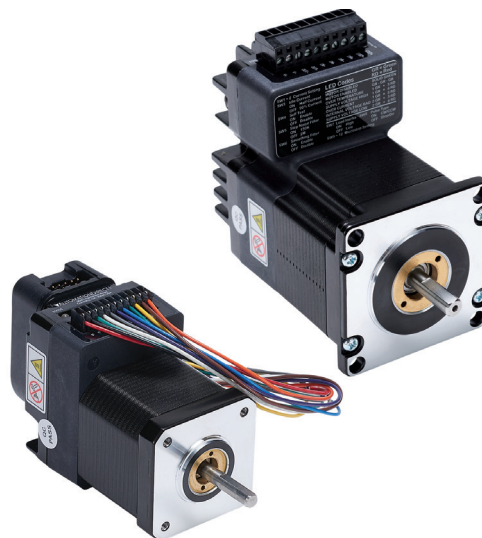

Standard NEMA 17 and 23 motor/drives

Standard integrated motor/drive features

(STP-MTRD-x)

- "E" models have an externally wireable encoder which can provide feedback to an external controller
- Configurable via DIP switches
- Available torque from 68 to 210 oz-in

Advanced integrated motor/drive features

(STP-MTRD-xR)

- Step and Direction, CW/CCW, and AB Quadrature/Encoder following
- Velocity (Oscillator) and position mode
- Control via streaming SCL commands
- RS-485 ASCII (2- or 4-wire) communications
- On "E" models, the internal encoder provides improved position and speed control
- Four "Variable I/O" points, 5 to 24 volts (NEMA 24 models)
- Analog input for speed and position, 0 to 5 VDC
- Configurable via SureMotion Pro software
- Available torque from 54 to 340 oz-in

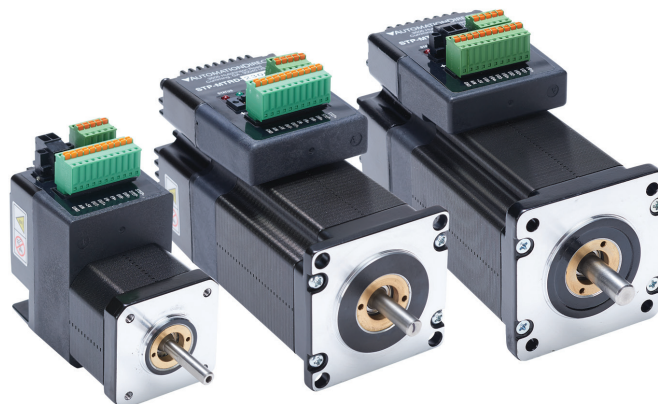

Advanced NEMA 17, 23, and 24 motor/drives

SureStep Series Part Numbers Standard Integrated Motor/Drives			
Integrated Motor/Drive	NEMA Size	Price	Drawing
STP-MTRD-17038	17	\$115.00	PDF
STP-MTRD-17038E	17	\$202.00	PDF
STP-MTRD-23042	23	\$178.00	PDF
STP-MTRD-23042E	23	\$265.00	PDF
STP-MTRD-23065	23	\$187.00	PDF
STP-MTRD-23065E	23	\$272.00	PDF

Note: Standard Integrated motor/drives with an "E" have an external encoder that can be wired to an external controller.

SureStep Series Part Numbers Advanced Integrated Motor/Drives			
Integrated Motor/Drive	NEMA Size	Price	Drawing
STP-MTRD-17030R	17	\$274.00	PDF
STP-MTRD-17030RE	17	\$352.00	PDF
STP-MTRD-17038R	17	\$287.00	PDF
STP-MTRD-17038RE	17	\$384.00	PDF
STP-MTRD-23042R	23	\$295.00	PDF
STP-MTRD-23042RE	23	\$409.00	PDF
STP-MTRD-23065R	23	\$307.00	PDF
STP-MTRD-23065RE	23	\$415.00	PDF
STP-MTRD-24075RV	24	\$415.00	PDF
STP-MTRD-24075RVE	24	\$493.00	PDF

Note: Advanced Integrated motor/drives with an "E" have an internal encoder used for stall prevention (cannot be wired to an external PLC or controller).



Stepping System Accessories

SureStep® Microstepping Drives Accessories

Braking Accessories

As a load rapidly decelerates from a high speed, much of the kinetic energy of that load is transferred back to the motor. This energy is then pushed back to the drive and power supply, resulting in increased system voltage. If there is enough overhauling load on the motor, the DC voltage will go above the drive and/or power supply limits. In general, the more torque the motor is capable of producing then the more energy it can push back into the drive.

When using a regulated/switching power supply, this can trip the overvoltage protection of the power supply or drive, and cause it to shut down.

To solve this problem, AutomationDirect offers a regeneration clamp as an optional accessory. The regen clamp has a built-in 50W braking resistor. The STP-DRVA-RC-050A does not have the ability to use an external resistor.



Regeneration Clamp STP-DRVA-RC-050A

Regeneration Clamp Features

STP-DRVA-RC-050A

- Built-in 50W power resistor for more continuous current handling
- Mounted on a heat sink
- Voltage range: 24–80 VDC; no user adjustments required
- Power: 50W continuous; 800W peak
- Indicators (LED):
Green = power supply voltage is present
Red = clamp is operating (usually when stepper is decelerating)
- Protection: The external power supply is internally connected to an “Input Diode” in the regen clamp that protects the power supply from high regeneration voltages. This diode protects the system from connecting the power supply in reverse. If the clamp circuit fails, the diode will continue to protect the power supply from over-voltage.
- Three drive connections, 7A max per channel, 15A total output current
- Removable terminal blocks (replacement kit STP-CON-4)
- Uses 18-20 AWG wire for connections

SureStep Damper

A step motor inertia damper can smooth out steps in a typical step motor resulting in a quieter and smoother motion when rotating between steps. Reducing the resonance and possible micro oscillations when moving from step to step is the main purpose of a “hockey puck” style damper, but it can also be used as a hand wheel to directly rotate the position of the rotor when power is removed from the motor. The damper is a properly sized machined piece of aluminum encased in plastic. It is sized and weighted for general damping of the respective frame size motor.



Damper

Sure Step Series Specifications – Microstepping Drives Optional Accessories			
Part Number	Price	Description	Drawing
<u>STP-DRVA-RC-050A</u> *	\$61.00	Regen Clamp: 50W, for DC input stepper and servo drives, enclosed	PDF
<u>STP-MTRA-17DMP</u>	\$15.00	SureStep damper, metal body. For use with NEMA 17 stepper motors with 5mm shafts. Mounting set screw included.	PDF
<u>STP-MTRA-23DMP</u>	\$34.50	SureStep damper, metal body. For use with NEMA 23 stepper motors with 1/4 inch shafts. Mounting set screw included.	PDF

* Do not use the regeneration clamp in an atmosphere containing corrosive gases.



Stepping System Accessories

SureStep® Microstepping Drives Accessories

USB to RS-485 Adapter

The STP-USB485-4W is a USB to RS-232/RS-485 converter that can be used in 2-wire or 4-wire serial networks. Serial communication can be wired up via the 9-pin D-sub connector or through the 6-screw terminals.

The STP-USB485-4W can be set for several different configurations. These modes are set up by the 4 DIP switches on the outside of the case (RS-232/RS-485, full/half duplex) and by the 7 jumpers located inside the case (termination/bias resistors).

SureStep Advanced Drives communicate via RS-232 (for control and for configuration via SureMotion Pro).

The Advanced Integrated motor/drives use RS-485. While the Advanced Integrated motor/drives can be wired for either 2- or 4-wire networks, 4-wire is require for use with SureMotion Pro due to the Firmware Download utility and the Status Monitor Screen.

Depending on the host controller's RS-485 implementation, either 2- or 4-wire RS-485 can be used for control. All RS-485 PLCs that have 2-wire capability (Productivity, BRX, Click, DirectLogic, etc.) can control the Advanced Integrated steppers.



SureStep PC Adapter - STP-USB485-4W	
Price	\$130.00
Drawing	PDF
Communications	2-wire RS-232 2- or 4-wire RS-485
Configure With	Internal jumpers and external DIP switches
Compatible Cables	STP-232RJ11-CBL STP-485DB9-CBL-2 USB

Dimensions = in [mm]

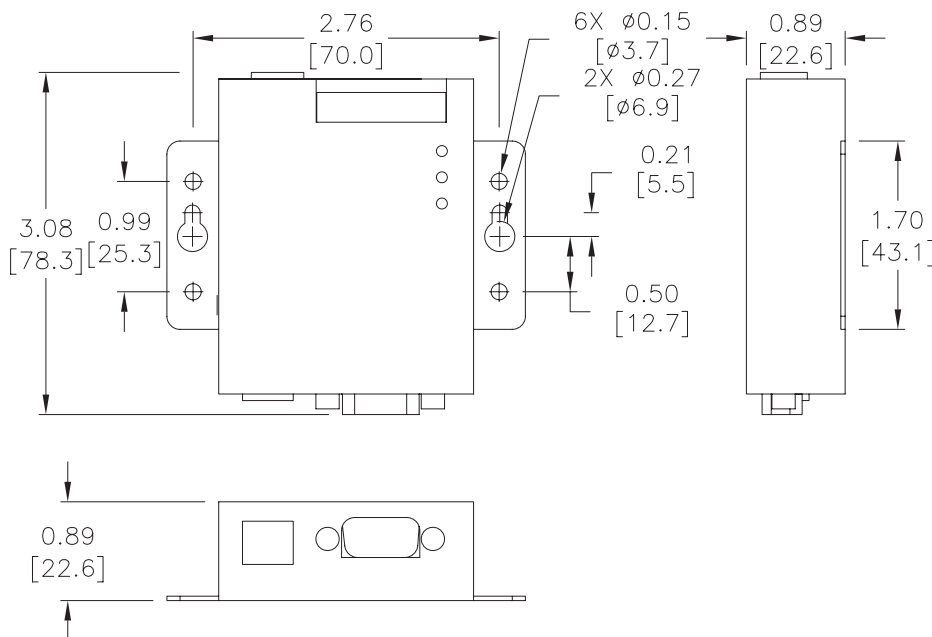



Stepping System Accessories

SureStep® Stepping System Encoders

Replacement Encoders

The [STP-MTRA-ENC1](#) is a replacement for the encoder that comes standard with the [STP-MTRD-17038E](#), [STP-MTRD-23042E](#), and [STP-MTRD-23065E](#) integrated motor/drives. Note that the encoder included with (E) model advanced integrated motor/drives is internal and cannot be replaced.

The [AMT112Q-V](#) is a replacement for the encoder that comes standard with the STP-MTR(x)-xxxxE stand alone step motors.

Installation tool and mounting hardware is included with all replacement encoders. For more information and details on how to wire the replacement encoders, please see the SureStep User Manual.

Optional Encoders

Optional encoders can be purchased separately for standard integrated motor/drives and standalone dual-shaft motors in all NEMA 14, 17, and 23 sizes, and also for STP-MTRAC-34xxxD motors (currently not available for STP-MTRx-34xxxD motors). All (D) model (dual-shaft) step motors come with pre-drilled holes in the rear end cap for easy encoder mounting. Pre-installed encoders on standalone dual-shaft motors and standard integrated motor/drives can be retrofitted with an appropriate optional encoder if desired. Please see the chart on the following page for encoder compatibility.

Features:

- Fixed resolutions include 400ppr or 1000ppr
- Configurable models have up to 4096ppr (default = 400ppr)
- Choose line driver or push-pull (totem) output signals



STP-MTRA-ENC2



AMT112Q-V



STP-MTRA-ENC11

Sure Step Series Specifications – Encoders			
Part Number	Price	Description	Drawing
STP-MTRA-ENC1	\$91.00	SureStep incremental (quadrature) modular encoder, 5VDC, line driver (differential) output, 1000 ppr. For use with SureStep stepper motors with 5mm rear shaft. Installation tool and mounting hardware included.	PDF
STP-MTRA-ENC2	\$79.00	SureStep incremental (quadrature) modular encoder, 5VDC, Push-pull (totem) output, 1000 ppr. For use with SureStep stepper motors with 5mm rear shaft. Installation tool and mounting hardware included.	PDF
STP-MTRA-ENC3	\$89.00	SureStep incremental (quadrature) modular encoder, 5VDC, line driver (differential) output, 400 ppr. For use with SureStep stepper motors with 5mm rear shaft. Installation tool and mounting hardware included.	PDF
STP-MTRA-ENC4	\$76.00	SureStep incremental (quadrature) modular encoder, 5VDC, Push-pull (totem) output, 400 ppr. For use with SureStep stepper motors with 5mm rear shaft. Installation tool and mounting hardware included.	PDF
STP-MTRA-ENC5	\$91.00	SureStep incremental (quadrature) modular encoder, 5VDC, line driver (differential) output, 1000 ppr. For use with SureStep stepper motors with 1/4 inch rear shaft. Installation tool and mounting hardware included.	PDF
STP-MTRA-ENC6	\$79.00	SureStep incremental (quadrature) modular encoder, 5VDC, Push-pull (totem) output, 1000 ppr. For use with SureStep stepper motors with 1/4 inch rear shaft. Installation tool and mounting hardware included.	PDF
STP-MTRA-ENC7	\$89.00	SureStep incremental (quadrature) modular encoder, 5VDC, line driver (differential) output, 400 ppr. For use with SureStep stepper motors with 1/4 inch rear shaft. Installation tool and mounting hardware included.	PDF
STP-MTRA-ENC8	\$76.00	SureStep incremental (quadrature) modular encoder, 5VDC, Push-pull (totem) output, 400 ppr. For use with SureStep stepper motors with 1/4 inch rear shaft. Installation tool and mounting hardware included.	PDF
STP-MTRA-ENC11	\$72.00	SureStep incremental (quadrature) modular encoder, 5 VDC, line driver (differential) output, 1000 ppr. For use with SureStep stepper motors with 3/8in rear shaft. Installation hardware included. Requires STP-CBL-EAxx cable.	PDF
STP-MTRA-ENC12	\$60.00	SureStep incremental (quadrature) modular encoder, 5 VDC, push-pull (totem) output, 1000 ppr. For use with SureStep stepper motors with 3/8in rear shaft. Installation hardware included. Requires STP-CBL-EDxx cable.	PDF
STP-MTRA-ENC13	\$61.00	SureStep incremental (quadrature) modular encoder, 5 VDC, line driver (differential) output, 400 ppr. For use with SureStep stepper motors with 3/8in rear shaft. Installation hardware included. Requires STP-CBL-EAxx cable.	PDF
STP-MTRA-ENC14	\$52.00	SureStep incremental (quadrature) modular encoder, 5 VDC, push-pull (totem) output, 400 ppr. For use with SureStep stepper motors with 3/8in rear shaft. Installation hardware included. Requires STP-CBL-EDxx cable.	PDF



Stepping System Accessories

SureStep® Stepping System Encoders

Sure Step Series Encoder Compatibility						
Part Number	PPR	Bore Diameter	Output Type	Encoder Cable	PLC Compatibility	Motor Compatibility
<u>STP-MTRA-ENC1</u>	1000	5mm	Line Driver	STP-CBL-EAxx	P2-HSI, P3-HSI, BRX*, CLICK C0-1xDxE-D*	STP-MTRx-14xxxD STP-MTRx-14xxxE STP-MTRx-17xxxD STP-MTRx-17xxxE Standard STP-MTRD-xxxxE
<u>STP-MTRA-ENC2</u>			Push-pull (totem)	STP-CBL-EDxx	BRX*, CLICK C0-1xDxE-D*	
<u>STP-MTRA-ENC3</u>	400		Line Driver	STP-CBL-EAxx	P2-HSI, P3-HSI, BRX*, CLICK C0-1xDxE-D*	
<u>STP-MTRA-ENC4</u>			Push-pull (totem)	STP-CBL-EDxx	BRX*, CLICK C0-1xDxE-D*	
<u>STP-MTRA-ENC5</u>	1000	0.25 inch	Line Driver	STP-CBL-EAxx	P2-HSI, P3-HSI, BRX*, CLICK C0-1xDxE-D*	STP-MTRx-23xxxD STP-MTRx-23xxxE STP-MTRAC-23xxxD
<u>STP-MTRA-ENC6</u>			Push-pull (totem)	STP-CBL-EDxx	BRX*, CLICK C0-1xDxE-D*	
<u>STP-MTRA-ENC7</u>	400		Line Driver	STP-CBL-EAxx	P2-HSI, P3-HSI, BRX*, CLICK C0-1xDxE-D*	
<u>STP-MTRA-ENC8</u>			Push-pull (totem)	STP-CBL-EDxx	BRX*, CLICK C0-1xDxE-D*	
<u>STP-MTRA-ENC11</u>	1000	0.375 inch	Line Driver	STP-CBL-EAxx	P2-HSI, P3-HSI, BRX*, CLICK C0-1xDxE-D*	STP-MTRAC-34xxxD
<u>STP-MTRA-ENC12</u>			Push-pull (totem)	STP-CBL-EDxx	BRX*, CLICK C0-1xDxE-D*	
<u>STP-MTRA-ENC13</u>	400		Line Driver	STP-CBL-EAxx	P2-HSI, P3-HSI, BRX*, CLICK C0-1xDxE-D*	
<u>STP-MTRA-ENC14</u>			Push-pull (totem)	STP-CBL-EDxx	BRX*, CLICK C0-1xDxE-D*	

* Requires FC-ISO-C



Stepping System Accessories

SureStep® Microstepping Drives Accessories

SureMotion Pro Drive Configuration Software - for Advanced Stepper Drives and Advanced Integrated Motor/Drives

Free Download

SureMotion Pro configuration software is available as a free download from our website for SureStep advanced components (STP-DRV-4850, -80100, & STP-MTRD-xxxxxR).

- Completely replaces SureStep Pro. Required for integrated motor/drives.
- Used for easy configuration and setup of the drive, including drive, motion control mode, I/O, motor.
- Open, Save, Upload, Download configuration files to Advanced Drives and Drive/Motors.
- Status Monitor screen aids in troubleshooting alarms and faults.
- Self Test Mode verifies motor wiring and functionality.
- SCL Terminal window allows testing/verification of SCL (serial ASCII) commands before PLC programming begins.
- Help files include technical data, application information, advanced setup, serial command instructions.
- Runs on 32-bit/64-bit Windows operating systems.



SureStep Drive Configuration Software - for Advanced Stepper Drives		
Part Number	Price	Description
SM-PRO	\$10.50	SureMotion Pro Windows configuration software, USB drive or free download. For use with SureStep stepper drives with serial port. Requires PC serial port, USB-RS232 or STP-USB485-4W serial adapters.

* Available for purchase on USB or can be [downloaded for free from the AutomationDirect Web site \(www.AutomationDirect.com\)](http://www.AutomationDirect.com).



Stepping System Cables

SureStep® Cables

SureStep Series – Stepping System Cables							
Cable	Price	Purpose	Length	Use With	Cable End Connectors	Drawing	
STP-EXT-006	\$13.00	motor to drive extension	6 ft	STP-MTR-xxxx(x)	pigtail / Molex 43020-0401 connector	PDF	
STP-EXT-010	\$14.50		10 ft			PDF	
STP-EXT-020	\$18.50		20 ft			PDF	
STP-EXTH-006	\$26.50		STP-MTRH-xxxx(x)	6 ft	pigtail / Molex 39-01-2041 connector	PDF	
STP-EXTH-010	\$31.50			10 ft		PDF	
STP-EXTH-020	\$38.00			20 ft		PDF	
STP-EXTHW-006	\$52.00		STP-MTRHW-xxxx(x)	6 ft	Bulgin # PXP4011/06P/6065	PDF	
STP-EXTHW-010	\$63.00			10 ft		PDF	
STP-EXTHW-020	\$95.00			20 ft		PDF	
STP-EXTL-006	\$11.50		motor to drive extension	6 ft	STP-MTRL-xxxx(x)	pigtail / Molex 105308-22004 connector	PDF
STP-EXTL-010	\$14.50			10 ft			PDF
STP-EXTL-020	\$18.00			20 ft			PDF
STP-EXTW-006	\$51.00	STP-MTRW-xxxx(x)		6 ft	Bulgin # PXP4011/06P/6065	PDF	
STP-EXTW-010	\$62.00			10 ft		PDF	
STP-EXTW-020	\$90.00			20 ft		PDF	
STP-EXT42-006	\$26.00	motor to drive extension		6 ft	STP-MTRAC-42xxxx	10-pin / pigtail	PDF
STP-EXT42-010	\$31.00			10 ft			PDF
STP-EXT42-020	\$44.50			20 ft			PDF
STP-EXT42H-006	\$26.00			STP-MTRACH-42xxxx	6 ft		PDF
STP-EXT42H-010	\$31.00				10 ft		PDF
STP-EXT42H-020	\$44.50				20 ft		PDF
STP-232RJ11-CBL*	\$11.00	programming/ communication	10 ft	STP-DRV-4850, STP-DRV-80100	DB9 female / RJ11(6P4C)	PDF	
STP-232HD15-CBL-2**	\$17.00	communication	6.6 ft	STP-DRV-4850, STP-DRV-80100 DL06, D2-250-1, D2-260	HD 15-pin male / RJ12 6-pin plug	n/a	
STP-232RJ12-CBL-2**	\$10.50	communication	6.6 ft	STP-DRV-4850, STP-DRV-80100 DL05, CLICK	RJ11 (6P4C) plug / RJ12 6-pin plug	n/a	
STP-CBL-CA6	\$19.00	control cable	6 ft	STP-MTRD-17038 STP-MTRD-17038E	11-pin / pigtail	PDF	
STP-CBL-CA10	\$23.00	control cable	10 ft		11-pin / pigtail	PDF	
STP-CBL-CA20	\$33.50	control cable	20 ft		11-pin / pigtail	PDF	
STP-CBL-EA6	\$19.00	encoder cable	6 ft	STP-MTRD-xxxxE STP-MTRA-ENC1, STP-MTRA-ENC3 STP-MTRA-ENC5, STP-MTRA-ENC7 STP-MTRA-ENC11, STP-MTRA-ENC13 (for line driver encoders)	10-pin / pigtail	PDF	
STP-CBL-EA10	\$23.00	encoder cable	10 ft		10-pin / pigtail	PDF	
STP-CBL-EA20	\$33.50	encoder cable	20 ft		10-pin / pigtail	PDF	
STP-CBL-EB3	\$60.00	encoder cable	3 ft	AMT112Q-V AMT112S-V (for both line driver and push-pull (totem) encoders)	17-pin / pigtail	PDF	
STP-CBL-EB6	\$83.00	encoder cable	6 ft		17-pin / pigtail	PDF	
STP-CBL-EB10	\$113.00	encoder cable	10 ft		17-pin / pigtail	PDF	
STP-CBL-EB20	\$187.00	encoder cable	20 ft		17-pin / pigtail	PDF	
STP-CBL-ED6	\$34.00	encoder cable	6 ft	STP-MTRA-ENC2, STP-MTRA-ENC4 STP-MTRA-ENC6, STP-MTRA-ENC8 STP-MTRA-ENC12, STP-MTRA-ENC14 (for push-pull (totem) encoders)	5-pin / pigtail	PDF	
STP-CBL-ED10	\$46.00	encoder cable	10 ft		5-pin / pigtail	PDF	
STP-CBL-ED20	\$55.00	encoder cable	20 ft		5-pin / pigtail	PDF	
STP-CON-1	\$18.00	replacement connector kit	n/a	STP-DRV-4845 & -6575	-	n/a	
STP-CON-2	\$18.00	replacement connector kit	n/a	STP-DRV-4850 & 80100	-	n/a	

* Programming/communication cable STP-232RJ11-CBL is available for spare or replacement purposes.
(One cable is included with each software programmable drive.)

** Refer to the ZIPLinks Wiring Solutions section for complete information regarding cables STP-232HD15-CBL-2 and STP-232RJ12-CBL-2.

SureStep® Cables, *continued*

SureStep Series – Stepping System Cables						
Cable	Price	Purpose	Length	Use With	Cable End Connectors	Drawing
STP-CON-3	\$36.50	replacement connector kit	n/a	STP-MTRD-xxxxR	-	n/a
STP-CON-4	\$18.00	replacement connector kit	n/a	STP-DRVA-RC-050A	-	n/a
STP-CON-5	\$18.00	replacement connector kit	n/a	STP-DRV-4830	-	PDF
STP-CON-6	\$23.50	replacement connector kit	n/a	STP-DRVAC-24025	-	n/a
STP-485DB9-CBL-2	\$42.00	4-wire programming cable	6.5 ft	STP-MTRD-xxxxR	DB9 / Phoenix 5-conductor plug	PDF

STP-EXT(x)-0xx Extension Cable Wiring Diagram

EXT & EXTH CABLES

PIN#	COLOR
1	RED
2	WHITE
3	GREEN
4	BLACK

EXTL CABLES

PIN#	COLOR
1	RED
2	WHITE
3	GREEN
4	BLACK

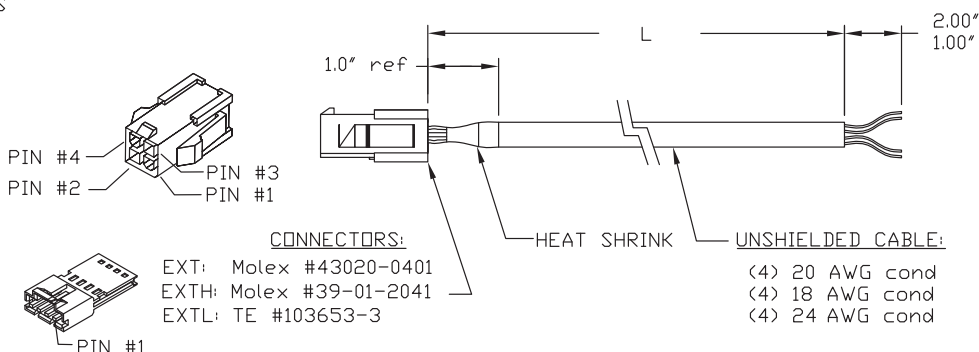

STP-EXTW-0xx and STP-EXTHW-0xx Extension Cable Wiring Diagram

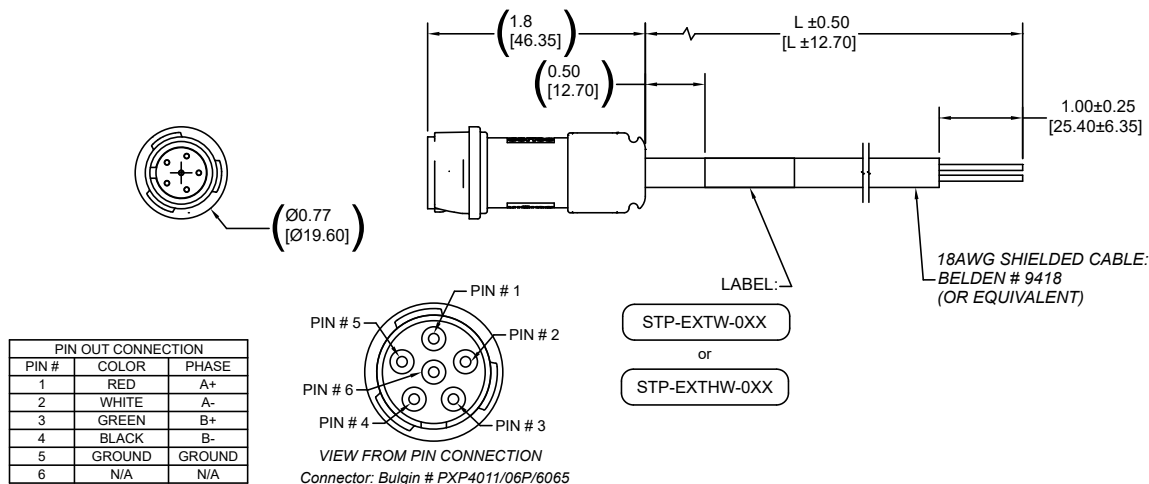

PIN OUT CONNECTION		
PIN #	COLOR	PHASE
1	RED	A+
2	WHITE	A-
3	GREEN	B+
4	BLACK	B-
5	GROUND	GROUND
6	N/A	N/A



Stepping Systems with PLCs

Controller Compatibility

High Speed Pulse Motion Control with AutomationDirect PLCs* and SureStep® Stepping Systems			
PLC Series	Starting at \$199.00	Starting at \$310.00	Starting at \$368.00
	BX-DM1x-10	BX-DM1x-18	BX-DM1x-36
Maximum Number of Axes	2	3	3
Output Signal Type	Sink/Source		
Maximum Pulse Rate (pulses/sec)	250,000		
Position Control	Trapezoidal Profiles (linear and S-curve ramps)		
Velocity Control	Dynamic Velocity (controlled accel/decel)		

High Speed Pulse Motion Control with AutomationDirect PLCs* and SureStep™ Stepping Systems				
1–16 axis control depending on base size and power supply budget **				
PLC Series	CPUs starting at \$361.00		CPUs starting at \$735.00	
		P2000		P3000
I/O Modules Pulse Outputs	P2-HSO		P3-HSO	
Maximum Number of Axes	2 per module, 22 per PLC rack, 44 per PLC system			
Output Signal Type	Line Driver	Sink/Source	Line Driver	Sink/Source
Maximum Pulse Rate (pulses/sec)	1,000,000	500,000	1,000,000	500,000
Position Control	Trapezoidal Profiles (linear and S-curve ramps)			
Velocity Control	Dynamic Velocity (controlled accel/decel)			
Maximum Number of Modules	11 per PLC rack, 22 per PLC system			

High Speed Pulse Motion Control with AutomationDirect PLCs* and SureStep® Stepping Systems			
PLC Series	Starting at Retired	Starting at \$212.00	Starting at \$392.00
	DL105	DL05	DL06
Built-In PLC Pulse Outputs	1 axis pulse output included with the PLC base unit		
Maximum Number of Axes	1 axis control**	1-2 axis control***	1-5 axis control***
Maximum Pulse Rate (pulses/sec)	7,000		10,000
Position Control	Trapezoidal Profiles (linear only)		
Velocity Control	Velocity Levels (no ramps available when changing velocity)		
I/O Modules Pulse Outputs	Not Applicable for DL105	H0-CTRIO2 (1 axis per module)	
Maximum Pulse Rate (pulses/sec)		65,000	
Position Control		Trapezoidal Profiles (linear & S-curve ramps)	
Velocity Control		Dynamic Velocity (controlled accel/decel)	
Maximum Number of Modules		1	4

* Any PLC capable of RS-232 ASCII communication can write serial commands to the STP-DRV-4850, -80100 Drives. Any PLC capable of RS-485 ASCII communication can write serial commands to the Advanced Integrated drives. Most AutomationDirect PLCs will communicate using either RS-232 or RS-485 communications, however we recommend using either Click, Productivity, or BRX (DoMore) as they are modern PLCs. DirectLogic will also work but is older technology.

** When using DC output models only. *** When using either DC output model or H0-CTRIO option module.



Stepping Systems with PLCs

Controller Compatibility (continued)

High Speed Pulse Motion Control with AutomationDirect PLCs* and SureStep™ Stepping Systems				
<i>1–16 axis control depending on base size and power supply budget **</i>				
PLC Series	CPUs starting at Retired		CPUs starting at \$411.00	
	DL205		Do-more	
I/O Modules Pulse Outputs	D2-CTRINT (1 axis per module)	H2-CTRIO2 (2 axes)	T1H-CTRIO (2 axes per module)	H2-CTRIO2 (2 axes)
Maximum Pulse Rate (pulses/sec)	5,000	65,000	25,000	250,000
Position Control	Trapezoidal Profiles (linear and S-curve ramps)			
Velocity Control	Dynamic Velocity (controlled accel/decel)			
Maximum Number of Modules	1	1-8		

* Any PLC capable of RS-232 ASCII communication can write serial commands to the STP-DRV-4850, -80100 Drives. Any PLC capable of RS-485 ASCII communication can write serial commands to the Advanced Integrated drives. Most AutomationDirect PLCs will communicate using either RS-232 or RS-485 communications, however we recommend using either Click, Productivity, or BRX (DoMore) as they are modern PLCs. DirectLogic will also work but is older technology.

** using D2-CITRANT or Hx-CTRIO modules.