

Stepping System Motors

SureStep® Stepping Motors

SureStep Series Part Numbers – Bipolar Stepping Motors*					
Bipolar Stepping Motors	Price	Shaft Type	Torque Level	Encoder Mounting	Drawing
STP-MTRL-14026	\$25.00	single	low	not available	PDF
STP-MTRL-14026D	\$29.50	dual		optional	PDF
STP-MTRL-14026E**	\$107.00	dual		pre-installed	PDF
STP-MTRL-14034	\$31.00	single		not available	PDF
STP-MTRL-14034D	\$36.50	dual		optional	PDF
STP-MTRL-14034E**	\$111.00	dual		pre-installed	PDF
STP-MTR-17040	\$22.50	single	high	not available	PDF
STP-MTR-17040D	\$26.50	dual		optional	PDF
STP-MTR-17040E**	\$103.00	dual		pre-installed	PDF
STP-MTR-17040W***	\$146.00	single		not available	PDF
STP-MTR-17048	\$26.50	single		not available	PDF
STP-MTR-17048D	\$31.00	dual		optional	PDF
STP-MTR-17048E**	\$108.00	dual		pre-installed	PDF
STP-MTR-17048W***	\$150.00	single		not available	PDF
STP-MTR-17060	\$43.00	single		not available	PDF
STP-MTR-17060D	\$48.50	dual		optional	PDF
STP-MTR-17060E**	\$125.00	dual		pre-installed	PDF
STP-MTR-17060W***	\$193.00	single		not available	PDF
STP-MTR-23055	\$42.50	single		not available	PDF
STP-MTR-23055D	\$48.50	dual		optional	PDF
STP-MTR-23055E**	\$126.00	dual	pre-installed	PDF	
STP-MTR-23055W***	\$181.00	single	not available	PDF	
STP-MTR-23079	\$55.00	single	not available	PDF	
STP-MTR-23079D	\$60.00	dual	optional	PDF	
STP-MTR-23079E**	\$137.00	dual	pre-installed	PDF	
STP-MTR-23079W***	\$196.00	single	not available	PDF	
STP-MTR-34066	\$129.00	single	high	not available	PDF
STP-MTR-34066D	\$146.00	dual		optional	PDF
STP-MTR-34066W***	\$234.00	single		not available	PDF
STP-MTRH-23079	\$61.00	single		not available	PDF
STP-MTRH-23079D	\$66.00	dual		optional	PDF
STP-MTRH-23079E**	\$144.00	dual		pre-installed	PDF
STP-MTRH-23079W***	\$291.00	single		not available	PDF
STP-MTRH-34066	\$144.00	single		not available	PDF
STP-MTRH-34066D	\$160.00	dual		optional	PDF
STP-MTRH-34066W***	\$331.00	single		not available	PDF
STP-MTRH-34097	\$163.00	single		not available	PDF
STP-MTRH-34097D	\$180.00	dual		optional	PDF
STP-MTRH-34097W***	\$371.00	single		not available	PDF
STP-MTRH-34127	\$192.00	single		not available	PDF
STP-MTRH-34127D	\$212.00	dual	optional	PDF	
STP-MTRH-34127W***	\$406.00	single	not available	PDF	

* For integrated motor/drives part numbers and pricing, see the integrated motor/drives section.

** E model motors come with an AMT112Q-V encoder pre-installed. Requires STP-CBL-EBxx for encoder wiring. To change from the default 400ppr, use AMT-PGRM-17C. See the SureStep Stepping System Encoders section for more details.

*** W models are IP65 washdown rated. All others are IP40.

**STP-MTR-xxxxx
(single-shaft)**

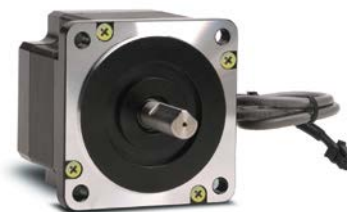

**STP-MTR-xxxxxE
(encoder mount)**



**STP-MTR-xxxxxD
(dual-shaft)**



**STP-MTR-xxxxxW
(IP65)**





Stepping System Motors

SureStep® Stepping Motors

SureStep Series Specifications – Connectorized Bipolar Stepping Motors													
Bipolar Stepping Motors	Low Voltage Low Torque		Low Voltage High Torque						Low Voltage Higher Torque				
	STP-MTRL-14026(x)	STP-MTRL-14034(x)	STP-MTR-17040(x)	STP-MTR-17048(x)	STP-MTR-17060(x)	STP-MTR-23055(x)	STP-MTR-23079(x)	STP-MTR-34066(x)	STP-MTRH-23079(x)	STP-MTRH-34066(x)	STP-MTRH-34097(x)	STP-MTRH-34127(x)	
NEMA Frame Size	14	14	17	17	17	23	23	34	23	34	34	34	
Maximum Holding Torque*	(lb·in)	0.5	1.25	3.81	5.19	7.19	10.37	17.25	27.12	17.87	27.12	50.00	80.50
	(oz·in)	8	20	61	83	115	166	276	434	286	434	800	1288
	(N·m)	0.06	0.14	0.43	0.59	0.81	1.17	1.95	3.06	2.02	3.06	5.65	9.10
Rotor Inertia	(oz·in ²)	0.06	0.08	0.28	0.37	0.56	1.46	2.60	7.66	2.60	7.66	14.80	21.90
	(kg·cm ²)	0.0003	0.00035	0.05	0.07	0.10	0.27	0.48	1.40	0.48	1.40	2.71	4.01
Rated Current (A/phase)	0.35	0.8	1.7	2.0	2.0	2.8	2.8	2.8	5.6	6.3	6.3	6.3	
Resistance (Ω/phase)	8.5	7.66	1.6	1.4	2.0	0.75	1.1	1.11	0.4	0.25	0.3	0.49	
Inductance (mH/phase)	5.77	6.92	3.0	2.7	3.3	2.4	3.8	6.6	1.2	1.5	2.1	4.1	
Insulation Class	130°C [266°F] Class B; 300V rms												
Basic Step Angle	1.8°												
Shaft Runout (in)	0.002 in [0.051 mm]												
Max Shaft Radial Play @ 1lb load	0.001 in [0.025 mm]												
Perpendicularity	0.003 in [0.076 mm]												
Concentricity	0.003 in [0.076 mm]												
Maximum Radial Load (lb [kg])*	6.0 [2.7]			15.0 [6.8]			39.0 [17.7]	15.0 [6.8]	39.0 [17.7]				
Maximum Thrust Load (lb [kg])*	6.0 [2.7]			13.0 [5.9]			25.0 [11.3]	13.0 [5.9]	25.0 [11.3]				
Storage Temperature Range	-20°C to 100°C [-4°F to 212°F]												
Operating Temperature Range	-20°C to 50°C [-4°F to 122°F] (motor case temperature should be kept below 80°C [176°F])												
Operating Humidity Range	55% to 85% non-condensing												
Product Material	steel motor case; stainless steel shaft(s)												
Environmental Rating	IP40 (IP65 for "W" motors)												
Weight (lb [kg]) (E models)	0.25 [0.11] (0.3 [0.1])	0.35 [0.15] (0.4 [0.2])	0.6 [0.3] (0.7 [0.3])	0.7 [0.3] (0.8 [0.4])	0.9 [0.4] (0.9 [0.4])	1.5 [0.7] (1.5 [0.7])	2.2 [1.0] (2.4 [1.1])	3.9 [1.7]	2.4 [1.1] (2.4 [1.1])	3.9 [1.7]	5.9 [2.7]	8.4 [3.8]	
Agency Approvals	CE												
Design Tips	<p>Allow sufficient time to accelerate the load and size the step motor with a 100% torque safety factor. DO NOT disassemble step motors because motor performance will be reduced and the warranty will be voided. DO NOT connect or disconnect the step motor during operation. Mount the motor to a surface with good thermal conductivity, such as steel or aluminum, to allow heat dissipation. Use a flexible coupling with "clamp-on" connections to both the motor shaft and the load shaft to prevent radial and thrust loading on bearings from minor misalignment.</p>												
Accessory Extension Cable	STP-EXTL-0xx		STP-EXT-0xx STP-EXTW-0xx (for "W" motors)					STP-EXTH-0xx STP-EXTHW-0xx (for "W" motors)					

* For dual-shaft motors (STP-MTR-xxxxxD):

The sum of the front and rear Torque Loads, Radial Loads, and Thrust Loads must not exceed the applicable Torque, Radial, and Thrust load ratings of the motor.



Stepping System Motors

SureStep® Motor Running Torque vs. Speed Charts

STP-MTRL-14xxx(x) NEMA 14 Step Motors

STP-MTRL-14026(x) Torque vs Speed (1.8° step motor; 1/2 stepping, RMS phase current)

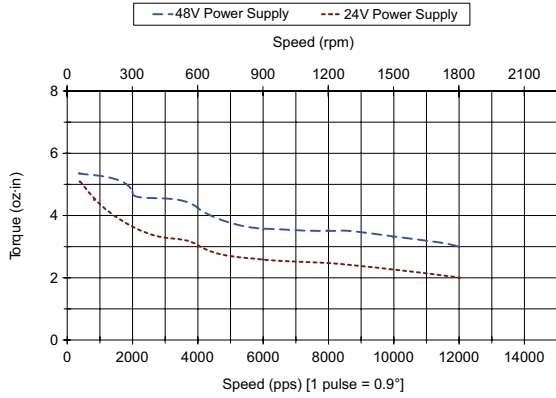

STP-MTRL-14034(x) Torque vs Speed (1.8° step motor; 1/2 stepping, RMS phase current)

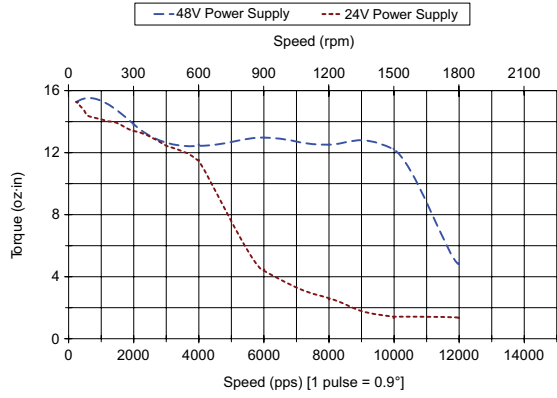

STP-MTR-17xxx(x) NEMA 17 Step Motors

Note: "W" series motors have 5% less running torque than other models

STP-MTR-17040(x) Torque vs Speed (1.8° step motor; 1/2 stepping)

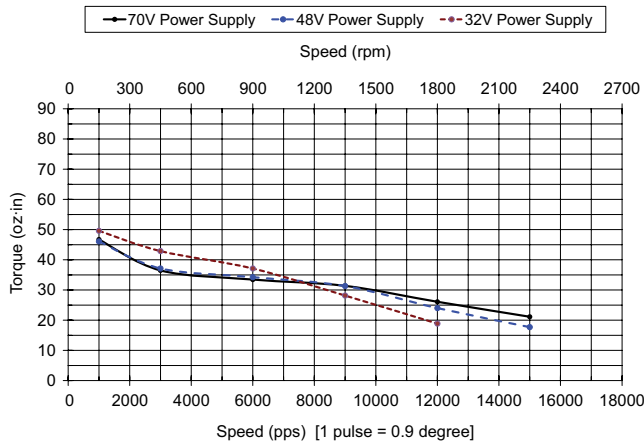

STP-MTR-17060(x) Torque vs Speed (1.8° step motor; 1/2 stepping)

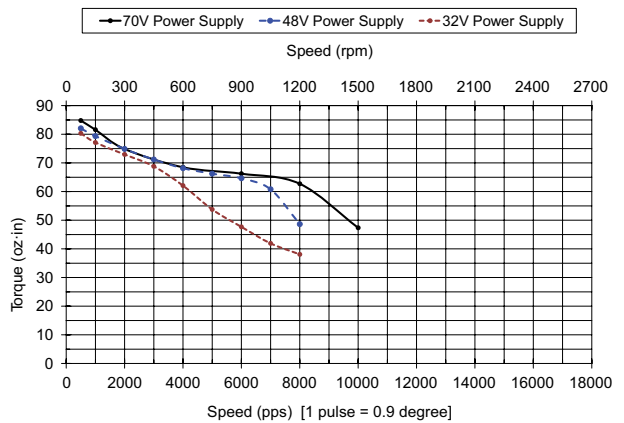

STP-MTR-17048(x) Torque vs Speed (1.8° step motor; 1/2 stepping)

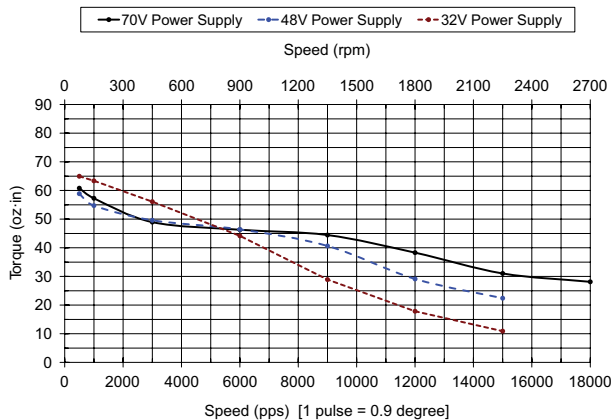

Note: Motor torque vs speed charts for STP-MTRD series integrated motor/drives can be found in the integrated motor/drives section of the full catalog



Stepping System Motors

SureStep® Motor Torque vs. Speed Charts (continued)

STP-MTR(H)-23xxx(x) NEMA 23 Step Motors

Note: "W" series motors have 5% less running torque than other models

STP-MTR-23055(x) Torque vs Speed (1.8° step motor; 1/2 stepping)

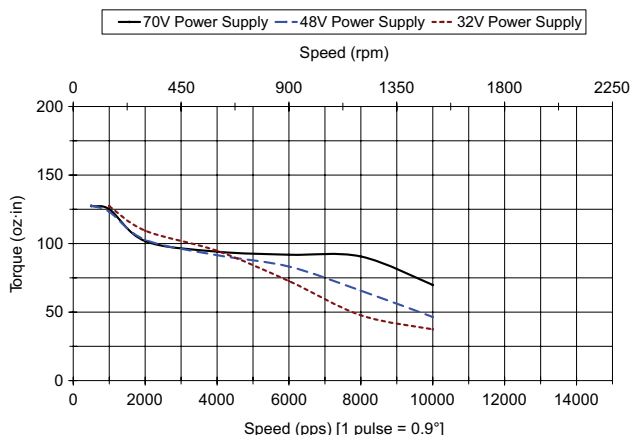

STP-MTRH-23079(x) Torque vs Speed (1.8° step motor; 1/2 stepping)

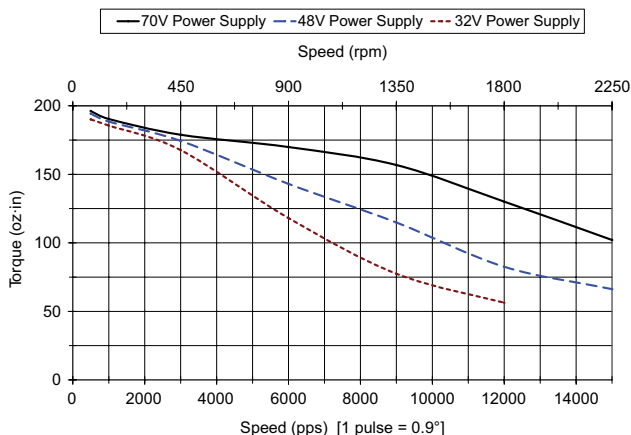

STP-MTR-23079(x) Torque vs Speed (1.8° step motor; 1/2 stepping)

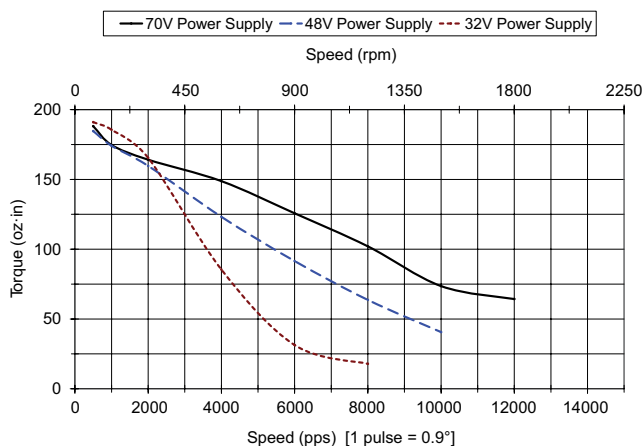

STP-MTRAC-23xxxx Torque vs Speed @ 340VDC bus (1.8° step motor; 1/2 stepping)

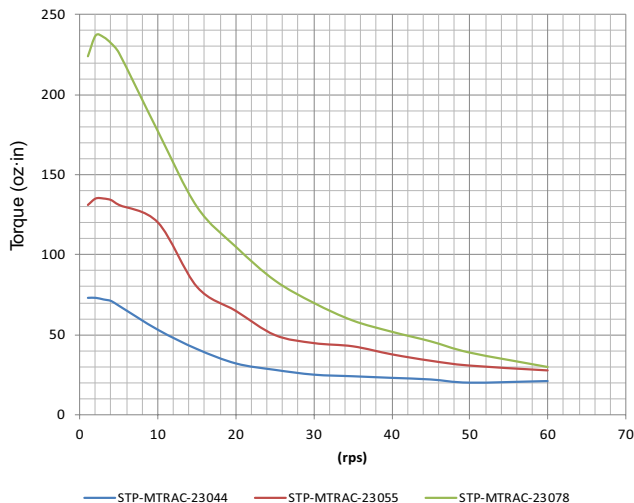



Stepping System Motors

SureStep® Motor Torque vs. Speed Charts (continued)

STP-MTR(H)-34xxx(x) NEMA 34 Step Motors

Note: "W" series motors have 5% less running torque than other models

STP-MTR-34066(x) Torque vs Speed (1.8° step motor; 1/2 stepping)

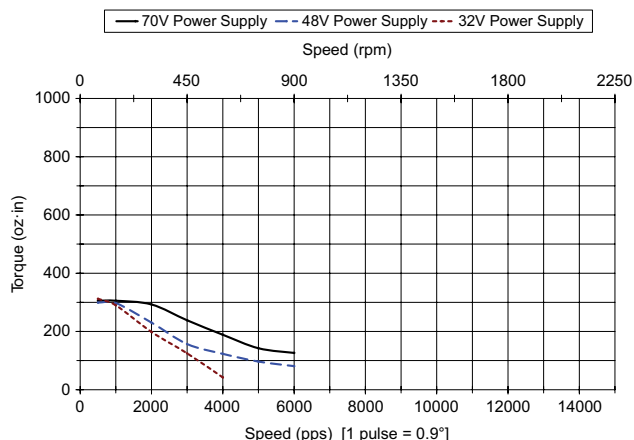

STP-MTRH-34066(x) Torque vs Speed (1.8° motor; 1/2 stepping)

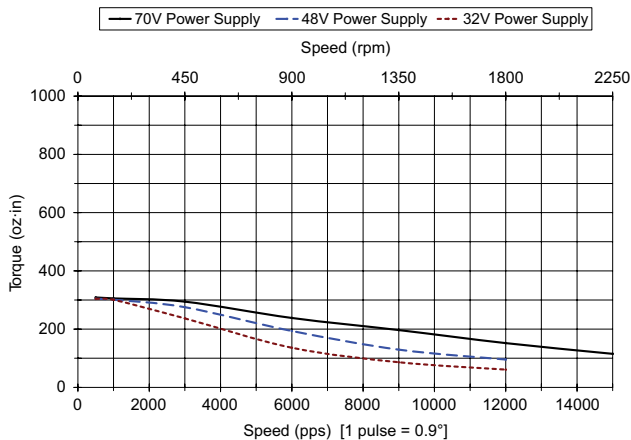

STP-MTRH-34097(x) Torque vs Speed (1.8° step motor; 1/2 stepping)

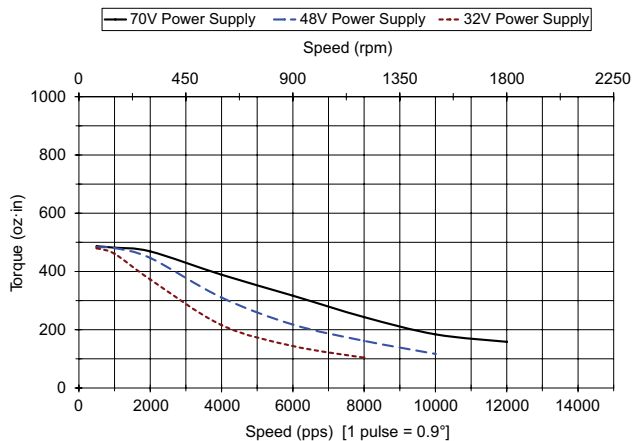

STP-MTRH-34127(x) Torque vs Speed (1.8° step motor; 1/2 stepping)

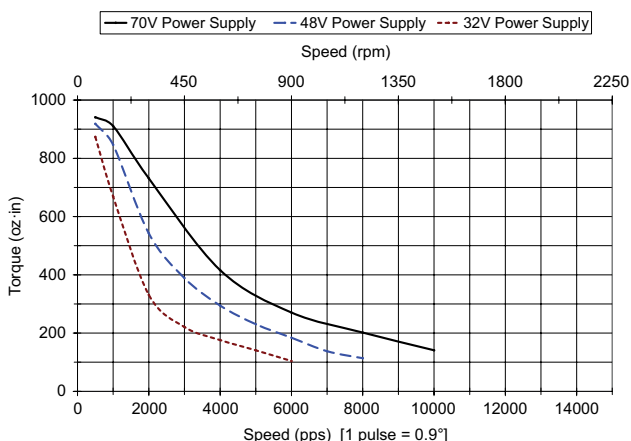

STP-MTRAC-34xxx Torque vs Speed @ 340VDC bus (1.8° step motor; 1/2 stepping)

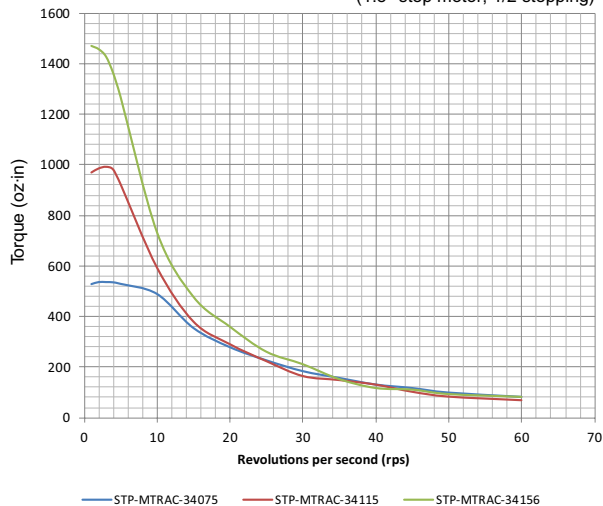



Stepping System Motors

SureStep® Motor Dimensions and Cabling

STP-MTR(x)-14,17,23xxx(X) Motors

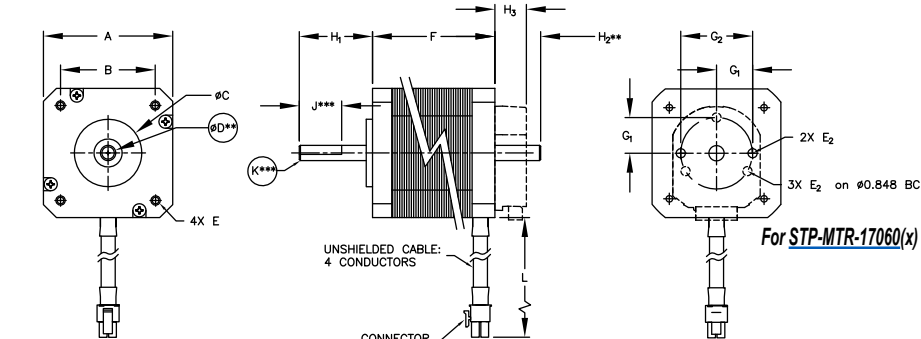

PIN # 1
CONNECTOR: VIEW FROM WIRE ENTRANCE

EXTL MOTORS		
PIN #	COLOR	PHASE
1	RED	A+
2	YELLOW	A-
3	GREEN	B+
4	BLACK	B-

PIN # 1, PIN # 2, PIN # 3, PIN # 4
CONNECTOR: VIEW FROM WIRE ENTRANCE

EXT & EXTH MOTORS		
PIN #	COLOR	PHASE
1	RED	A+
2	WHITE	A-
3	GREEN	B+
4	BLACK	B-

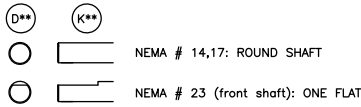

** Dimension H2 applies only to dual-shaft (D) and encoder (E) motors.
Dimension D is the same for both front and rear shafts of dual-shaft and encoder motors.
Dimensions J & K do NOT apply to rear shafts of dual-shaft and encoder motors (all rear shafts are round style).

STP-MTR-xxxxxW Motors

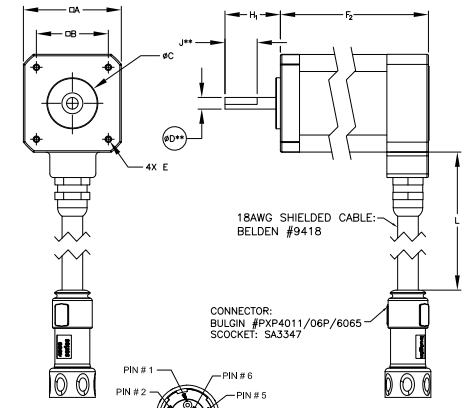

PIN # 1, PIN # 2, PIN # 3, PIN # 4, PIN # 5, PIN # 6
VIEW FROM PIN INSERT

PIN OUT CONNECTION		
PIN #	COLOR	PHASE
1	RED	A+
2	WHITE	A-
3	GREEN	B+
4	BLACK	B-
5	GROUND	GROUND
6	N/A	N/A

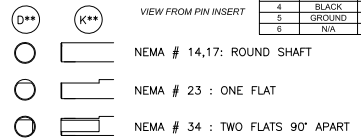

Note: Drawings and dimensions for STP-MTRD series integrated motor/drives can be found in the integrated motor/drives section of the manual

SureStep Series Dimensions & Cabling – NEMA 14, 17, and 23 Connectorized Bipolar Stepping Motors

Dimensions* (in [mm]*)	Low Torque Motors		High Torque Motors					Higher Torque Motors
	STP-MTRL-14026(x)	STP-MTRL-14034(x)	STP-MTR-17040(x)	STP-MTR-17048(x)	STP-MTR-17060(x)	STP-MTR-23055(x)	STP-MTR-23079(x)	STP-MTRH-23079(x)
A	1.39 [35.3]	1.39 [35.3]	1.67 [42.3]			2.25 [57.2]		2.25 [57.2]
B	1.02 [25.9]	1.02 [25.9]	1.22 [31.0]			1.86 [47.2]		1.86 [47.2]
C			Ø 0.87 [22.1]			Ø 1.50 [38.1]		Ø 1.50 [38.1]
D**			Ø 0.20 [5.0]			Ø 0.25 [6.4]		Ø 0.25 [6.4]
E	4-40 thread 0.15 [3.8] min depth		M3 x 0.5 thread 0.15 [3.8] min depth			Ø 0.20 [5.1] through		Ø 0.20 [5.1] through
E2	M2.5 x 0.45 thread	M2.5 x 0.45 thread	M2.5 x 0.45 thread		M2 x 0.4 thread	4-40		4-40
F**	1.02 [25.9]	1.34 [34.0]	1.58 [40.1]	1.89 [48.0]	2.34 [59.5]	2.22 [56.4]	3.10 [78.7]	3.10 [78.7]
F2**	n/a		1.90 [48.3]	2.24 [56.9]	2.67 [67.8]	2.33 [59.1]	3.19 [81.0]	3.19 [81.0]
G1	0.375	0.375	0.375	0.375	0.411	0.906	0.906	0.906
G2	0.75	0.75	0.75	0.75	n/a	1.812	1.812	1.812
H1	0.60 [15.2]	0.60 [15.2]	0.94 [24.0]			0.81 [20.6]		0.81 [20.6]
H2**			0.51 [13.0]					
H3***			0.40					
J**			n/a			0.59 [15.0]		
K**			n/a			0.23 [5.8]		
L			12 [305]					
Conductor	(4) #26 AWG		(4) #20 AWG, (5) #18 AWG (for W motors)					(4) #18 AWG, (5) #18 AWG (for W motors)
Connector	TE # 103653-3		Molex # 43025-0400, PXP4010/06S/6065 (for W motors)					Molex # 39-01-3042, PXP4010/06S/6065 (for W motors)
Pin	TE # 1-104505-3 (LOOSE)		Molex # 43030-0007, Socket: SA3347 (for W motors)					Molex # 39-00-0039, Socket: SA3347 (for W motors)

* mm dimensions are for reference purposes only.
** Dimension H2 applies only to dual-shaft (D) and encoder (E) motors.
Dimension D (shaft diameter) is the same for both front and rear shafts of dual-shaft (D) and encoder (E) motors.
Dimensions J & K do NOT apply to rear shafts of dual-shaft (D) and encoder (E) motors (all rear shafts are round style).
Dimension F2 applies to IP65 (W) motors only.
*** Dimension H3 applies only to "E" models with the encoder pre-mounted.



Stepping System Motors

SureStep® Motor Dimensions and Cabling

STP-MTR(x)-34xxx(X) Motors

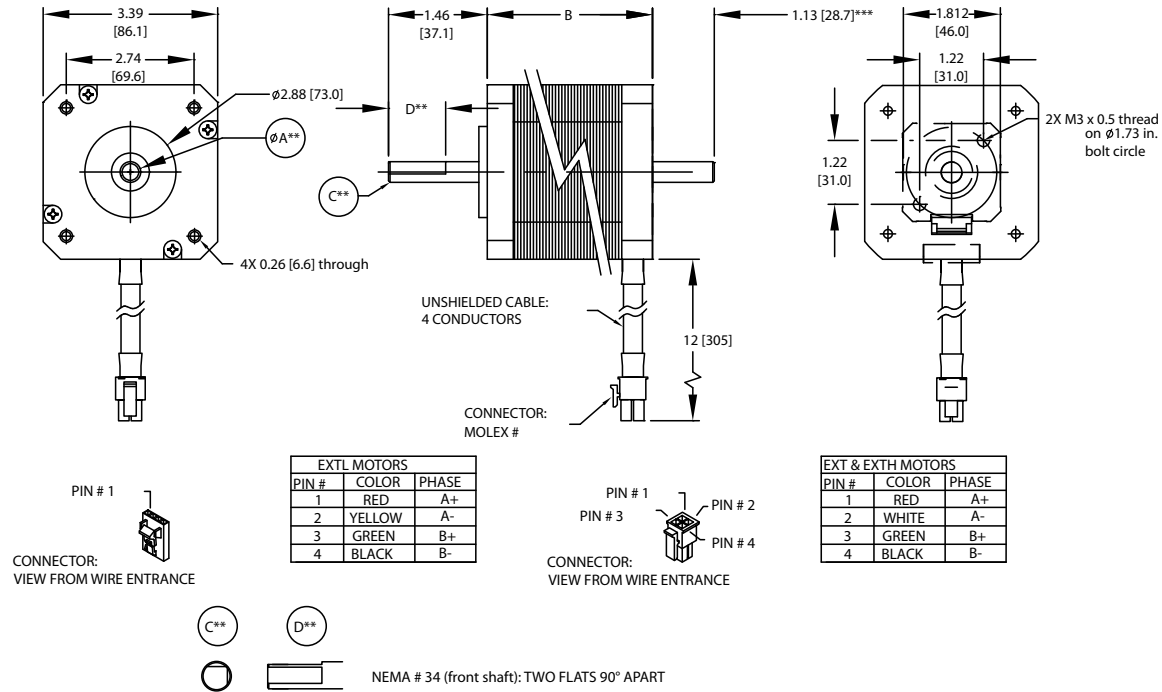

** Dimension A is the same for both front and rear shafts of dual-shaft motors.
 ** Dimensions C & D do NOT apply to rear shafts of dual-shaft motors (all rear shafts are round style).
 *** Dimension applies only to dual-shaft (D) motors.

SureStep Series Dimensions & Cabling – NEMA 34 Connectorized Bipolar Stepping Motors				
Dimensions (in [mm]*)	High Torque Motors		Higher Torque Motors	
	STP-MTR-34066(x)	STP-MTRH-34066(x)	STP-MTRH-34097(x)	STP-MTRH-34127(x)
A**	Ø 0.50 [12.7]			
B	2.64 [67.1]	2.64 [67.1]	3.82 [97.0]	5.00 [127.0]
C**	0.98 [25.0]			
D**	0.45 [11.4]			
Conductor	(4) #20 AWG, (5) #18 AWG (for W motors)		(4) #18 AWG, (5) #18 AWG (for W motors)	
Connector	Molex # 43025-0400, PXP4010/06S/6065 (for W motors)		Molex # 39-01-3042, PXP4010/06S/6065 (for W motors)	
Pin	Molex # 43030-0007, Socket: SA3347 (for W motors)		Molex # 39-00-0039, Socket: SA3347 (for W motors)	

* mm dimensions are for reference purposes only.
 ** Dimension A (shaft diameter) is the same for both front and rear shafts of dual-shaft (D series) motors. Dimensions C & D do NOT apply to rear shafts of dual-shaft (D series) motors (all rear shafts are round style).
 *** This dimension only applies to dual-shaft (D series) motors.



Stepping System Accessories

SureStep® Microstepping Drives Accessories

Braking Accessories

As a load rapidly decelerates from a high speed, much of the kinetic energy of that load is transferred back to the motor. This energy is then pushed back to the drive and power supply, resulting in increased system voltage. If there is enough overhauling load on the motor, the DC voltage will go above the drive and/or power supply limits. In general, the more torque the motor is capable of producing then the more energy it can push back into the drive.

When using a regulated/switching power supply, this can trip the overvoltage protection of the power supply or drive, and cause it to shut down.

To solve this problem, AutomationDirect offers a regeneration clamp as an optional accessory. The regen clamp has a built-in 50W braking resistor. The STP-DRVA-RC-050A does not have the ability to use an external resistor.



Regeneration Clamp [STP-DRVA-RC-050A](#)

Regeneration Clamp Features

[STP-DRVA-RC-050A](#)

- Built-in 50W power resistor for more continuous current handling
- Mounted on a heat sink
- Voltage range: 24–80 VDC; no user adjustments required
- Power: 50W continuous; 800W peak
- Indicators (LED):
Green = power supply voltage is present
Red = clamp is operating (usually when stepper is decelerating)
- Protection: The external power supply is internally connected to an “Input Diode” in the regen clamp that protects the power supply from high regeneration voltages. This diode protects the system from connecting the power supply in reverse. If the clamp circuit fails, the diode will continue to protect the power supply from over-voltage.
- Three drive connections, 7A max per channel, 15A total output current
- Removable terminal blocks (replacement kit STP-CON-4)
- Uses 18-20 AWG wire for connections

SureStep Damper

A step motor inertia damper can smooth out steps in a typical step motor resulting in a quieter and smoother motion when rotating between steps. Reducing the resonance and possible micro oscillations when moving from step to step is the main purpose of a “hockey puck” style damper, but it can also be used as a hand wheel to directly rotate the position of the rotor when power is removed from the motor. The damper is a properly sized machined piece of aluminum encased in plastic. It is sized and weighted for general damping of the respective frame size motor.



Damper

Sure Step Series Specifications – Microstepping Drives Optional Accessories			
Part Number	Price	Description	Drawing
STP-DRVA-RC-050A *	\$61.00	Regen Clamp: 50W, for DC input stepper and servo drives, enclosed	PDF
STP-MTRA-17DMP	\$15.00	SureStep damper, metal body. For use with NEMA 17 stepper motors with 5mm shafts. Mounting set screw included.	PDF
STP-MTRA-23DMP	\$34.50	SureStep damper, metal body. For use with NEMA 23 stepper motors with 1/4 inch shafts. Mounting set screw included.	PDF

* Do not use the regeneration clamp in an atmosphere containing corrosive gases.



Stepping System Accessories

SureStep[®] Microstepping Drives Accessories

Dimensions = in [mm]

STP-DRVA-RC-050A

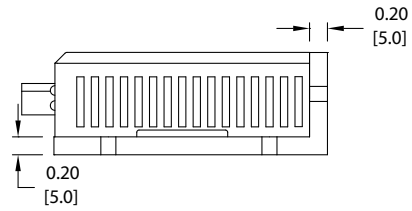
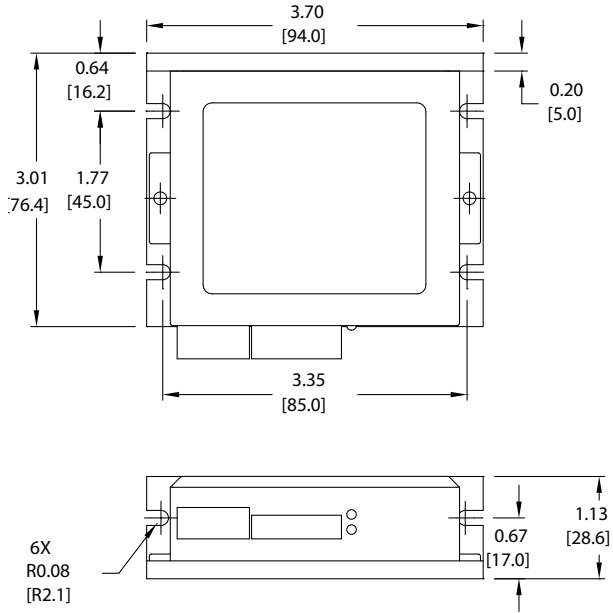



Stepping System Cables

SureStep® Cables

SureStep Series – Stepping System Cables						
Cable	Price	Purpose	Length	Use With	Cable End Connectors	Drawing
STP-EXT-006	\$13.00	motor to drive extension	6 ft	STP-MTR-xxxx(x)	pigtail / Molex 43020-0401 connector	PDF
STP-EXT-010	\$14.50		10 ft			PDF
STP-EXT-020	\$18.50		20 ft			PDF
STP-EXTH-006	\$26.50		6 ft	STP-MTRH-xxxx(x)	pigtail / Molex 39-01-2041 connector	PDF
STP-EXTH-010	\$31.50		10 ft			PDF
STP-EXTH-020	\$38.00		20 ft			PDF
STP-EXTHW-006	\$50.00		6 ft	STP-MTRHW-xxxx(x)	Bulgin # PXP4011/06P/6065	PDF
STP-EXTHW-010	\$55.00		10 ft			PDF
STP-EXTHW-020	\$71.00		20 ft			PDF
STP-EXTL-006	\$11.50		6 ft	STP-MTRL-xxxx(x)	pigtail / Molex 105308-22004 connector	PDF
STP-EXTL-010	\$14.50		10 ft			PDF
STP-EXTL-020	\$18.00		20 ft			PDF
STP-EXTW-006	\$50.00	6 ft	STP-MTRW-xxxx(x)	Bulgin # PXP4011/06P/6065	PDF	
STP-EXTW-010	\$55.00	10 ft			PDF	
STP-EXTW-020	\$71.00	20 ft			PDF	
STP-EXT42-006	\$26.00	motor to drive extension	6 ft	STP-MTRAC-42xxxx	10-pin / pigtail	PDF
STP-EXT42-010	\$31.00		10 ft			PDF
STP-EXT42-020	\$44.50		20 ft			PDF
STP-EXT42H-006	\$26.00		6 ft	STP-MTRACH-42xxxx		PDF
STP-EXT42H-010	\$31.00		10 ft			PDF
STP-EXT42H-020	\$44.50		20 ft			PDF
STP-232RJ11-CBL*	\$11.00	programming/ communication	10 ft	STP-DRV-4850, STP-DRV-80100	DB9 female / RJ11(6P4C)	PDF
STP-232HD15-CBL-2**	\$17.00	communication	6.6 ft	STP-DRV-4850, STP-DRV-80100 DL06, D2-250-1, D2-260	HD 15-pin male / RJ12 6-pin plug	n/a
STP-232RJ12-CBL-2**	\$10.50	communication	6.6 ft	STP-DRV-4850, STP-DRV-80100 DL05, CLICK	RJ11 (6P4C) plug / RJ12 6-pin plug	n/a
STP-CBL-CA6	\$19.00	control cable	6 ft	STP-MTRD-17038 STP-MTRD-17038E	11-pin / pigtail	PDF
STP-CBL-CA10	\$23.00	control cable	10 ft		11-pin / pigtail	PDF
STP-CBL-CA20	\$33.50	control cable	20 ft		11-pin / pigtail	PDF
STP-CBL-EA6	\$19.00	encoder cable	6 ft	STP-MTRD-xxxxE STP-MTRA-ENC1, STP-MTRA-ENC3 STP-MTRA-ENC5, STP-MTRA-ENC7 STP-MTRA-ENC11, STP-MTRA-ENC13 (for line driver encoders)	10-pin / pigtail	PDF
STP-CBL-EA10	\$23.00	encoder cable	10 ft		10-pin / pigtail	PDF
STP-CBL-EA20	\$33.50	encoder cable	20 ft		10-pin / pigtail	PDF
STP-CBL-EB3	\$60.00	encoder cable	3 ft	AMT112Q-V AMT112S-V (for both line driver and push-pull (totem) encoders)	17-pin / pigtail	PDF
STP-CBL-EB6	\$83.00	encoder cable	6 ft		17-pin / pigtail	PDF
STP-CBL-EB10	\$113.00	encoder cable	10 ft		17-pin / pigtail	PDF
STP-CBL-EB20	\$187.00	encoder cable	20 ft		17-pin / pigtail	PDF
STP-CBL-ED6	\$19.00	encoder cable	6 ft	STP-MTRA-ENC2, STP-MTRA-ENC4 STP-MTRA-ENC6, STP-MTRA-ENC8 STP-MTRA-ENC12, STP-MTRA-ENC14 (for push-pull (totem) encoders)	5-pin / pigtail	PDF
STP-CBL-ED10	\$23.50	encoder cable	10 ft		5-pin / pigtail	PDF
STP-CBL-ED20	\$34.50	encoder cable	20 ft		5-pin / pigtail	PDF
STP-CON-1	\$18.00	replacement connector kit	n/a	STP-DRV-4845 & -6575	-	n/a
STP-CON-2	\$18.00	replacement connector kit	n/a	STP-DRV-4850 & 80100	-	n/a

* Programming/communication cable [STP-232RJ11-CBL](#) is available for spare or replacement purposes.
(One cable is included with each software programmable drive.)

** Refer to the [ZIPLinks Wiring Solutions](#) section for complete information regarding cables [STP-232HD15-CBL-2](#) and [STP-232RJ12-CBL-2](#).

SureStep® Cables, *continued*

SureStep Series – Stepping System Cables						
Cable	Price	Purpose	Length	Use With	Cable End Connectors	Drawing
STP-CON-3	\$36.50	replacement connector kit	n/a	STP-MTRD-xxxxR	-	n/a
STP-CON-4	\$18.00	replacement connector kit	n/a	STP-DRVA-RC-050A	-	n/a
STP-CON-5	\$18.00	replacement connector kit	n/a	STP-DRV-4830	-	PDF
STP-CON-6	\$23.50	replacement connector kit	n/a	STP-DRVAC-24025	-	n/a
STP-485DB9-CBL-2	\$42.00	4-wire programming cable	6.5 ft	STP-MTRD-xxxxR	DB9 / Phoenix 5-conductor plug	PDF

STP-EXT(x)-0xx Extension Cable Wiring Diagram

EXT & EXTH CABLES

PIN#	COLOR
1	RED
2	WHITE
3	GREEN
4	BLACK

EXTL CABLES

PIN#	COLOR
1	RED
2	WHITE
3	GREEN
4	BLACK

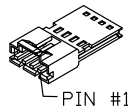
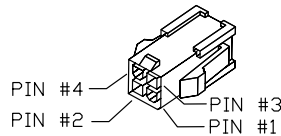

CONNECTORS:

EXT: Molex #43020-0401
 EXTH: Molex #39-01-2041
 EXTL: TE #103653-3

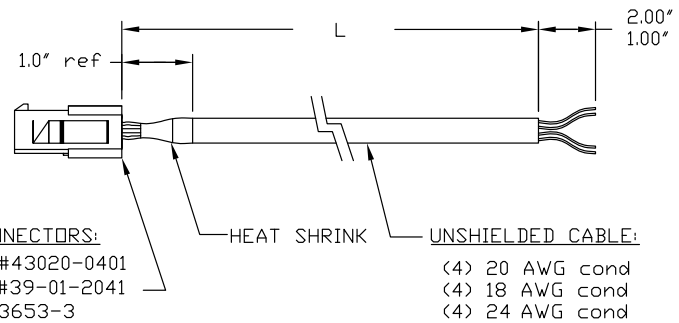

STP-EXTW-0xx and STP-EXTHW-0xx Extension Cable Wiring Diagram

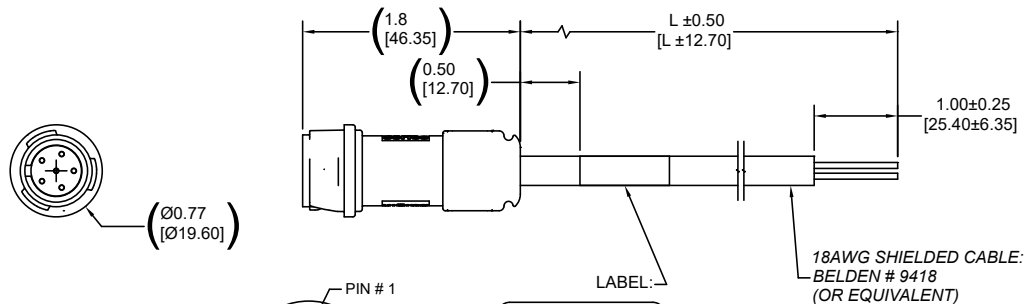

PIN OUT CONNECTION		
PIN #	COLOR	PHASE
1	RED	A+
2	WHITE	A-
3	GREEN	B+
4	BLACK	B-
5	GROUND	GROUND
6	N/A	N/A

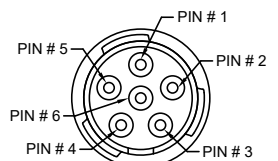

VIEW FROM PIN CONNECTION
 Connector: Bulgin # PXP4011/06P/6065

LABEL:
 STP-EXTW-0XX
 or
 STP-EXTHW-0XX