



Stepping System Cables

SureStep® Cables

SureStep Series – Stepping System Cables						
Cable	Price	Purpose	Length	Use With	Cable End Connectors	Drawing
STP-EXT-006	\$13.00	motor to drive extension	6 ft	STP-MTR-xxxx(x)	pigtail / Molex 43020-0401 connector	PDF
STP-EXT-010	\$14.50		10 ft			PDF
STP-EXT-020	\$18.50		20 ft			PDF
STP-EXTH-006	\$26.50		STP-MTRH-xxxx(x)	6 ft	pigtail / Molex 39-01-2041 connector	PDF
STP-EXTH-010	\$31.50			10 ft		PDF
STP-EXTH-020	\$38.00			20 ft		PDF
STP-EXTHW-006	\$50.00		STP-MTRHW-xxxx(x)	6 ft	Bulgin # PXP4011/06P/6065	PDF
STP-EXTHW-010	\$55.00			10 ft		PDF
STP-EXTHW-020	\$71.00			20 ft		PDF
STP-EXTL-006	\$11.50		STP-MTRL-xxxx(x)	6 ft	pigtail / Molex 105308-22004 connector	PDF
STP-EXTL-010	\$14.50			10 ft		PDF
STP-EXTL-020	\$18.00			20 ft		PDF
STP-EXTW-006	\$50.00	STP-MTRW-xxxx(x)	6 ft	Bulgin # PXP4011/06P/6065	PDF	
STP-EXTW-010	\$55.00		10 ft		PDF	
STP-EXTW-020	\$71.00		20 ft		PDF	
STP-EXT42-006	\$26.00	motor to drive extension	6 ft	STP-MTRAC-42xxxx	10-pin / pigtail	PDF
STP-EXT42-010	\$31.00		10 ft			PDF
STP-EXT42-020	\$44.50		20 ft			PDF
STP-EXT42H-006	\$26.00		6 ft	STP-MTRACH-42xxxx		PDF
STP-EXT42H-010	\$31.00		10 ft			PDF
STP-EXT42H-020	\$44.50		20 ft			PDF
STP-232RJ11-CBL*	\$11.00	programming/ communication	10 ft	STP-DRV-4850, STP-DRV-80100	DB9 female / RJ11(6P4C)	PDF
STP-232HD15-CBL-2**	\$17.00	communication	6.6 ft	STP-DRV-4850, STP-DRV-80100 DL06, D2-250-1, D2-260	HD 15-pin male / RJ12 6-pin plug	n/a
STP-232RJ12-CBL-2**	\$10.50	communication	6.6 ft	STP-DRV-4850, STP-DRV-80100 DL05, CLICK	RJ11 (6P4C) plug / RJ12 6-pin plug	n/a
STP-CBL-CA6	\$19.00	control cable	6 ft	STP-MTRD-17038 STP-MTRD-17038E	11-pin / pigtail	PDF
STP-CBL-CA10	\$23.00	control cable	10 ft		11-pin / pigtail	PDF
STP-CBL-CA20	\$33.50	control cable	20 ft		11-pin / pigtail	PDF
STP-CBL-EA6	\$19.00	encoder cable	6 ft	STP-MTRD-xxxxE STP-MTRA-ENC1, STP-MTRA-ENC3 STP-MTRA-ENC5, STP-MTRA-ENC7 STP-MTRA-ENC11, STP-MTRA-ENC13 (for line driver encoders)	10-pin / pigtail	PDF
STP-CBL-EA10	\$23.00	encoder cable	10 ft		10-pin / pigtail	PDF
STP-CBL-EA20	\$33.50	encoder cable	20 ft		10-pin / pigtail	PDF
STP-CBL-EB3	\$60.00	encoder cable	3 ft	AMT112Q-V AMT112S-V (for both line driver and push-pull (totem) encoders)	17-pin / pigtail	PDF
STP-CBL-EB6	\$83.00	encoder cable	6 ft		17-pin / pigtail	PDF
STP-CBL-EB10	\$113.00	encoder cable	10 ft		17-pin / pigtail	PDF
STP-CBL-EB20	\$187.00	encoder cable	20 ft		17-pin / pigtail	PDF
STP-CBL-ED6	\$19.00	encoder cable	6 ft	STP-MTRA-ENC2, STP-MTRA-ENC4 STP-MTRA-ENC6, STP-MTRA-ENC8 STP-MTRA-ENC12, STP-MTRA-ENC14 (for push-pull (totem) encoders)	5-pin / pigtail	PDF
STP-CBL-ED10	\$23.50	encoder cable	10 ft		5-pin / pigtail	PDF
STP-CBL-ED20	\$34.50	encoder cable	20 ft		5-pin / pigtail	PDF
STP-CON-1	\$18.00	replacement connector kit	n/a	STP-DRV-4845 & -6575	-	n/a
STP-CON-2	\$18.00	replacement connector kit	n/a	STP-DRV-4850 & 80100	-	n/a

* Programming/communication cable [STP-232RJ11-CBL](#) is available for spare or replacement purposes.
(One cable is included with each software programmable drive.)

** Refer to the [ZIPLinks Wiring Solutions](#) section for complete information regarding cables [STP-232HD15-CBL-2](#) and [STP-232RJ12-CBL-2](#).

SureStep® Cables, *continued*

SureStep Series – Stepping System Cables						
Cable	Price	Purpose	Length	Use With	Cable End Connectors	Drawing
STP-CON-3	\$36.50	replacement connector kit	n/a	STP-MTRD-xxxxR	-	n/a
STP-CON-4	\$18.00	replacement connector kit	n/a	STP-DRVA-RC-050A	-	n/a
STP-CON-5	\$18.00	replacement connector kit	n/a	STP-DRV-4830	-	PDF
STP-CON-6	\$23.50	replacement connector kit	n/a	STP-DRVAC-24025	-	n/a
STP-485DB9-CBL-2	\$42.00	4-wire programming cable	6.5 ft	STP-MTRD-xxxxR	DB9 / Phoenix 5-conductor plug	PDF

STP-EXT(x)-0xx Extension Cable Wiring Diagram

EXT & EXTH CABLES

PIN#	COLOR
1	RED
2	WHITE
3	GREEN
4	BLACK

EXTL CABLES

PIN#	COLOR
1	RED
2	WHITE
3	GREEN
4	BLACK

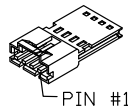
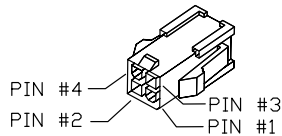

CONNECTORS:

EXT: Molex #43020-0401
 EXTH: Molex #39-01-2041
 EXTL: TE #103653-3

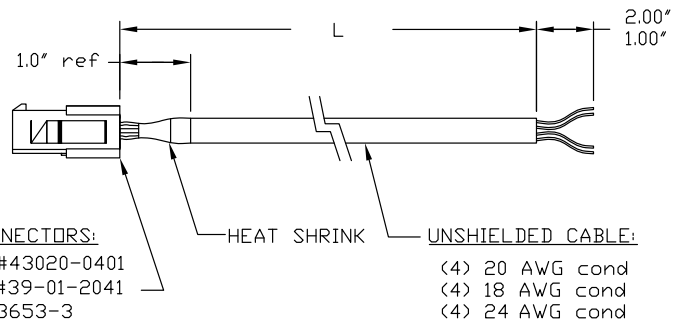

STP-EXTW-0xx and STP-EXTHW-0xx Extension Cable Wiring Diagram

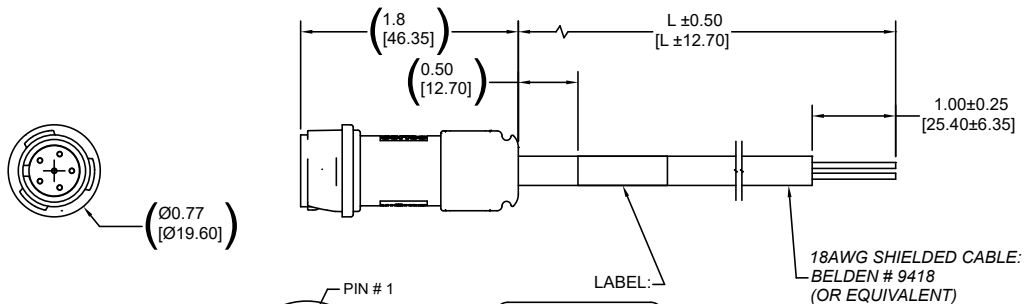

PIN OUT CONNECTION		
PIN #	COLOR	PHASE
1	RED	A+
2	WHITE	A-
3	GREEN	B+
4	BLACK	B-
5	GROUND	GROUND
6	N/A	N/A

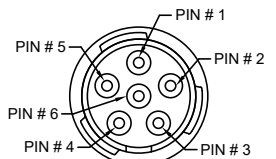

VIEW FROM PIN CONNECTION
 Connector: Bulgin # PXP4011/06P/6065

LABEL:
 STP-EXTW-0XX
 or
 STP-EXTHW-0XX



Stepping System Cables

SureStep® Cables, continued

STP-232RJ11-CBL Programming Cable Wiring Diagram

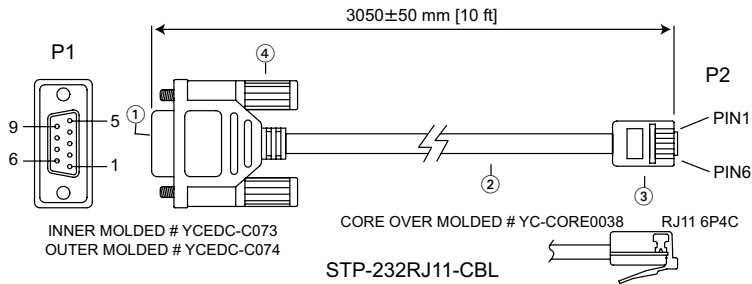

WIRE CONNECTION

(DB9) P1		P2 (RJ11 6P4C)
2	RX	TX
3	TX	RX
4	nc	nc
5	GND	GND

①	DB 9P FEMALE CONNECTOR SHELL: FRONT NICKEL BACK TIN INSULATOR COLOR: BLACK
②	CABLE: CAT-5 UTP 24AWG (7/0.203BA*2PR) 100MHz COLOR: BLACK OD: 4.5mm
③	RJ11 6P4C PLATED GOLD 3U"
④	SCREW: #4-40UNC PD40*175TNP COLOR: BLACK

STP-485DB9-CBL-2 4-wire Programming Cable Wiring Diagram

CONNECTION CHART				
DB-9 CONN PIN	DB9 SIGNAL	WIRE COLOR	PHOENIX PIN	PHOENIX SIGNAL
2	TX+	RED	5	RX+
1	TX-	ORANGE	4	RX-
3	RX+	BLACK	3	TX+
4	RX-	BROWN	2	TX-
5	GND	YELLOW	1	GND
METAL HOUSING	SHIELD	SHIELD	N/C	N/C

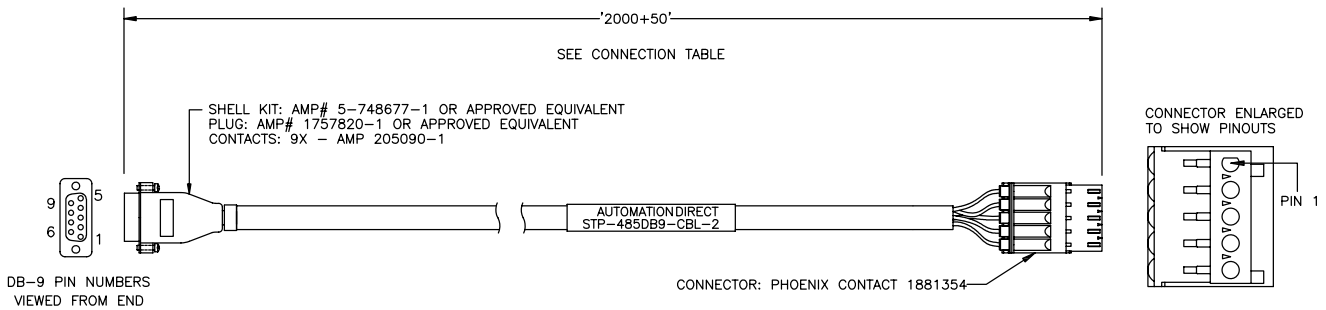

SureStep® Cables, continued

STP-CBL-CAXx Control Cable Wiring Diagram

C 1		
PIN NO.	SIGNAL	WIRE COLOR
1	STEP+	ORANGE
2	STEP-	BROWN
3	DIR+	YELLOW
4	DIR-	GREEN
5	EN+	BLUE
6	EN-	TAN
7	OUT+	GRAY
8	OUT-	WHITE
9	N.C.	PINK
10	V-	BLACK
11	V+	RED
12	N/C	PURPLE - CUT

Note: For Rev A of this cable, STEP+ is Grey/Pink and EN- is Red/Blue

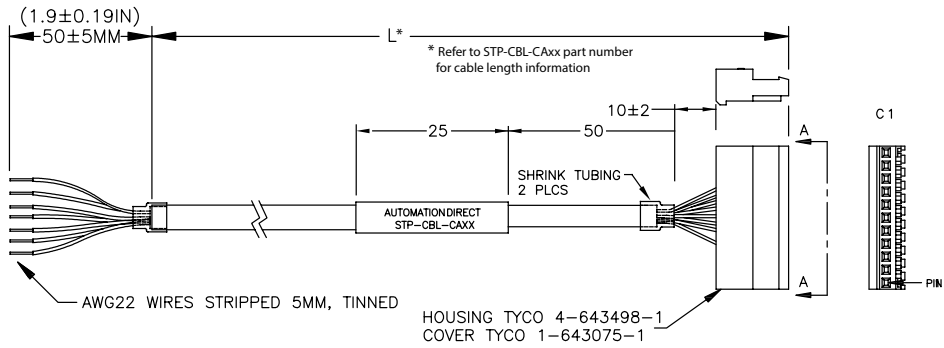

STP-CBL-EAxx Encoder Cable Wiring Diagram

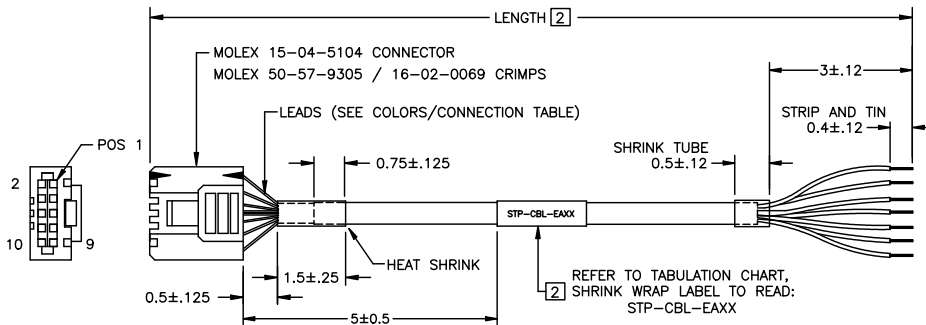

CONN	CONNECTION TABLE		
PIN	LEAD COLOR	SIGNAL	
2	GREEN/WHITE	GROUND	TWISTED PAIR
7	GREEN	POWER+	
3	ORANGE/WHITE	Z-	TWISTED PAIR
4	ORANGE	Z+	
5	BLUE/WHITE	A-	TWISTED PAIR
6	BLUE	A+	
9	BROWN/WHITE	B-	TWISTED PAIR
10	BROWN	B+	
1	N/C	N/A	NO CONNECTION
8	N/C	N/A	

WIRE: 24AWG, CABLE: UL2464.

STP-CBL-EBxx Encoder Cable Wiring Diagram

- NOTE:
- Case_GND is connected internally to GND (BLACK/RED)
 - Ground connected internally to cable shielding-customer ref. only
 - Tolerance: ± 0.2" [5] unless otherwise specified
 - All materials must be ROHS compliant

TABLE INFORMATION	
CABLE NUMBER	CABLE LENGTH L
STP-CBL-EB3	3 Feet
STP-CBL-EB6	6 Feet
STP-CBL-EB10	10 Feet
STP-CBL-EB20	20 Feet

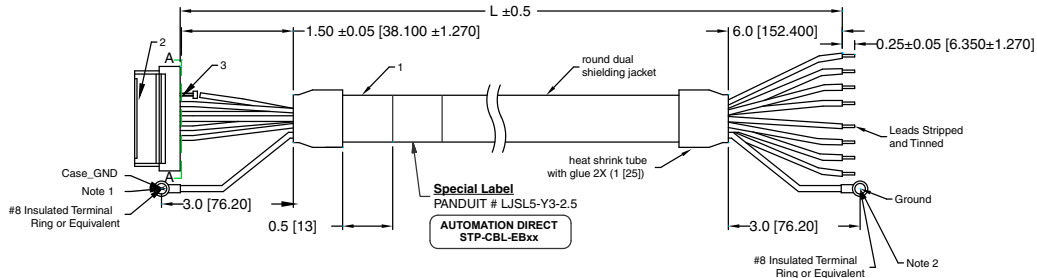

Connector Pinout			
#	Function	Primary Color	Stripe
4	GND	Black	Red
6	+5V	Red	Black
8	B+	Green	Black
9	B-	Black	Green
10	A+	White	Black
11	A-	Black	White
12	Z+	Blue	Black
13	Z-	Black	Blue

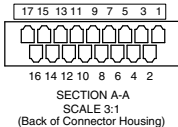

PARTS LIST			
#	PART	DESCRIPTION	QTY
1	CABLE	3M # 3600B/14	1
2	CONNECTOR	JAE # FI-W175	1
3	CRIMP PINS	JAE # FI-C3-A1-15000	8



Stepping System Cables

SureStep® Cables, continued

STP-CBL-EDxx Encoder Cable Wiring Diagram

STP-EDxx CABLES

PIN#	Function	Color
1	Ground	Black
2	Index	Green
3	A Channel	White
4	+5VDC Power	Red
5	B Channel	Brown

TABLE INFORMATION	
CABLE NUMBER	CABLE LENGTH L
STP-CBL-ED6	6 Feet
STP-CBL-ED10	10 Feet
STP-CBL-ED20	20 Feet

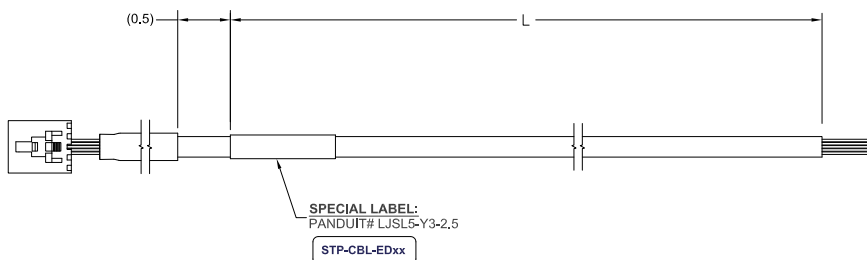

STP-EXT42(H)-xxx Cable Wiring Diagram

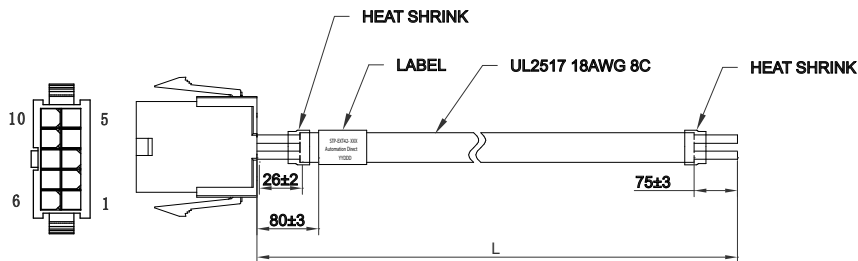

Pin	Wire Description
1	A - White
2	\bar{A} - Orange
3	C - Green
4	\bar{C} - Brown
5	B - Red
6	\bar{B} - Yellow
7	D - Black
8	\bar{D} - Blue
9	GND - Drain wire

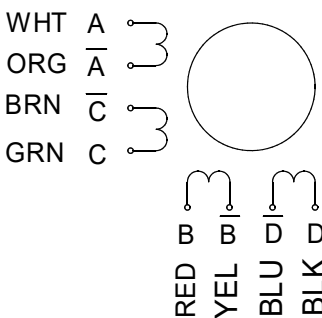

Bi-polar series

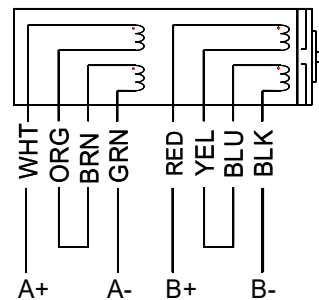

Bi-polar parallel

