

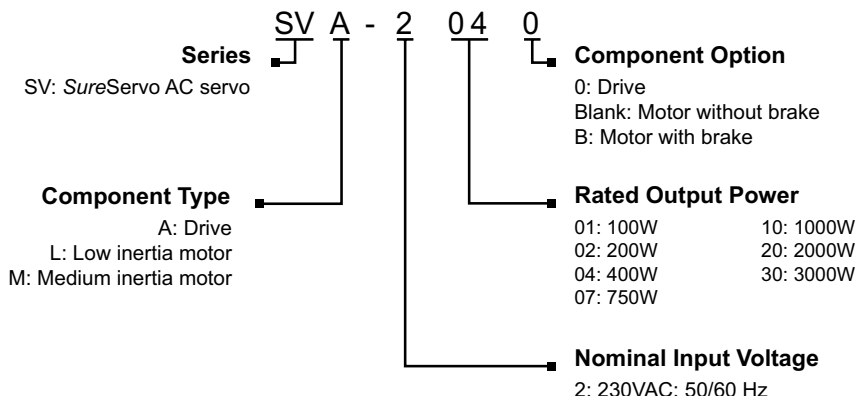

# AC Servo System Configuration

## SureServo series drives and motors part numbering system



Here is what you will need to order a complete servo system:



NOTE: Unit can be programmed via keypad.  
Optional programming software (free download) and optional programming cable available.



NOTE: If you need a gear box for your configuration, you can do it easily online:  
<http://www.sureservo.com/gearbox-selector>



## SureServo AC servo drive, motor, and cable combinations

Inertia & Power		Drive and Motor			Power Cables (from Drive to Motor)				Encoder Feedback Cables				Miscellaneous	
Inertia	Power	Servo Drive	Servo Motor without brake (note)	Servo Motor with brake (note)	10 ft	20 ft	30 ft	60 ft	10 ft	20 ft	30 ft	60 ft	ZIPLink I/O Interface	RS-422/485 Serial Communication Cable
Low inertia	100W	SVA-2040	<a href="#">SVL-201</a>	<a href="#">SVL-201B</a>	SVC-PFL-010	SVC-PFL-020	SVC-PFL-030	SVC-PFL-060	SVC-EFL-010	SVC-EFL-020	SVC-EFL-030	SVC-EFL-060	ZL-RTB50  and  ZL-SVC-CBL50 or ZL-SVC-CBL50-1 or ZL-SVC-CBL50-2	SVC-MDCOM-CBL
	200W		<a href="#">SVL-202</a>	<a href="#">SVL-202B</a>										
	400W		<a href="#">SVL-204</a>	<a href="#">SVL-204B</a>										
	750W		<a href="#">SVL-207</a>	<a href="#">SVL-207B</a>										
	1000W		<a href="#">SVL-210</a>	<a href="#">SVL-210B</a>										
Medium inertia	1000W	SVA-2100	<a href="#">SVM-210</a>	<a href="#">SVM-210B</a>	SVC-PHM-010	SVC-PHM-020	SVC-PHM-030	SVC-PHM-060	SVC-EHH-010	SVC-EHH-020	SVC-EHH-030	SVC-EHH-060	ZL-SVC-CBL50 or ZL-SVC-CBL50-1 or ZL-SVC-CBL50-2	SVC-MDCOM-CBL
	2000W	SVA-2300	<a href="#">SVM-220</a>	<a href="#">SVM-220B</a>	SVC-PHH-010	SVC-PHH-020	SVC-PHH-030	SVC-PHH-060						
	3000W	<a href="#">SVM-230</a>	<a href="#">SVM-230B</a>	SVC-PHH-010	SVC-PHH-020	SVC-PHH-030	SVC-PHH-060							

Note: Each servo motor requires an encoder feedback cable and a power cable.  
The motor power cable includes brake power wires for the optional motor brake.



# AC Servo System Configuration

For all systems:

Order programming software & programming cable if needed. See pages SRV-151 & page SRV-163.

## 100W Low Inertia System

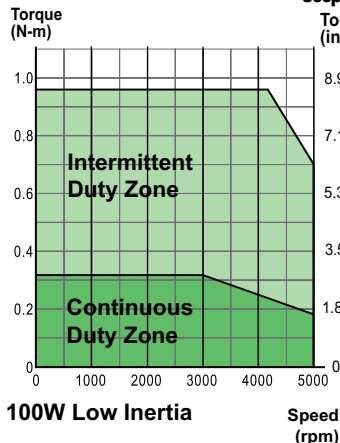

100W Low Inertia

Speed (rpm)



Servo Drive **SVA-2040** Retired

Jm= Motor Inertia = 0.000027 lb-in-s2 (0.000003 kg - m2)

SureServo Motor

2.   
**SVL-201** Retired  
**SVL-201B (w/brake)** Retired

Motor Power Cable (1)

3.   
**SVC-PFL-010 (10')** \$51.00  
**SVC-PFL-020 (20')** \$96.00  
**SVC-PFL-030 (30')** \$121.00  
**SVC-PFL-060 (60')** \$218.00

Motor Encoder Cable (1)

4.   
**SVC-EFL-010 (10')** Retired  
**SVC-EFL-020 (20')** \$141.00  
**SVC-EFL-030 (30')** \$165.00  
**SVC-EFL-060 (60')** \$209.00

Z/PLink I/O Interface

5.   
**ZL-RTB50** \$74.00  
 and one cable below:  
**ZL-SVC-CBL50 (0.5m)** \$48.50  
**ZL-SVC-CBL50-1 (1m)** \$51.00  
**ZL-SVC-CBL50-2 (2m)** \$58.00

## 200W Low Inertia System

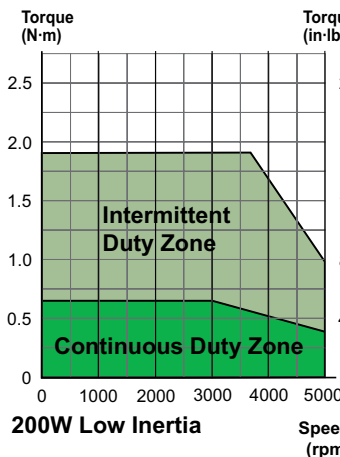

200W Low Inertia

Speed (rpm)



Servo Drive **SVA-2040** Retired

Jm= Motor Inertia = 0.00016 lb-in-s2 (0.000018 kg - m2)

SureServo Motor

2.   
**SVL-202** Retired  
**SVL-202B (w/brake)** Retired

Motor Power Cable (1)

3.   
**SVC-PFL-010 (10')** \$51.00  
**SVC-PFL-020 (20')** \$96.00  
**SVC-PFL-030 (30')** \$121.00  
**SVC-PFL-060 (60')** \$218.00

Motor Encoder Cable (1)

4.   
**SVC-EFL-010 (10')** Retired  
**SVC-EFL-020 (20')** \$141.00  
**SVC-EFL-030 (30')** \$165.00  
**SVC-EFL-060 (60')** \$209.00

Z/PLink I/O Interface

5.   
**ZL-RTB50** \$74.00  
 and one cable below:  
**ZL-SVC-CBL50 (0.5m)** \$48.50  
**ZL-SVC-CBL50-1 (1m)** \$51.00  
**ZL-SVC-CBL50-2 (2m)** \$58.00

## 400W Low Inertia System

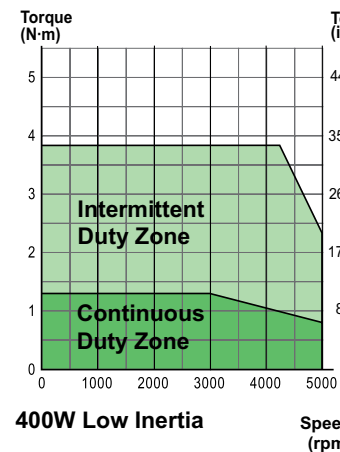

400W Low Inertia

Speed (rpm)



Servo Drive **SVA-2040** Retired

Jm= Motor Inertia = 0.0003 lb-in-s2 (0.000034 kg - m2)

SureServo Motor

2.   
**SVL-204** Retired  
**SVL-204B (w/brake)** Retired

Motor Power Cable (1)

3.   
**SVC-PFL-010 (10')** \$51.00  
**SVC-PFL-020 (20')** \$96.00  
**SVC-PFL-030 (30')** \$121.00  
**SVC-PFL-060 (60')** \$218.00

Motor Encoder Cable (1)

4.   
**SVC-EFL-010 (10')** Retired  
**SVC-EFL-020 (20')** \$141.00  
**SVC-EFL-030 (30')** \$165.00  
**SVC-EFL-060 (60')** \$209.00

Z/PLink I/O Interface

5.   
**ZL-RTB50** \$74.00  
 and one cable below:  
**ZL-SVC-CBL50 (0.5m)** \$48.50  
**ZL-SVC-CBL50-1 (1m)** \$51.00  
**ZL-SVC-CBL50-2 (2m)** \$58.00



# AC Servo System Configuration

For all systems:

## 750W Low Inertia System

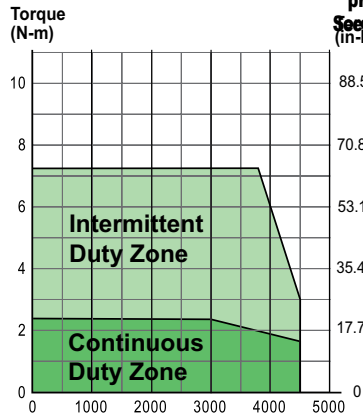

750W Low Inertia

Jm= Motor Inertia = .00096 lb-in-s<sup>2</sup> (0.000108 kg - m<sup>2</sup>)

Order programming software & programming cable if needed. See page SRV-151 & page SRV-163.



Servo Drive **SVA-2100** Retired

SureServo Motor



- 2. **SVL-207** Retired
- SVL-207B (w/brake)** Retired

Motor Power Cable (1)



- 3. **SVC-PFL-010 (10')** \$51.00
- SVC-PFL-020 (20')** \$96.00
- SVC-PFL-030 (30')** \$121.00
- SVC-PFL-060 (60')** \$218.00

Motor Encoder Cable (1)



- 4. **SVC-EFL-010 (10')** Retired
- SVC-EFL-020 (20')** \$141.00
- SVC-EFL-030 (30')** \$165.00
- SVC-EFL-060 (60')** \$209.00

Z/PLink I/O Interface



- 5. **ZL-RTB50** \$74.00
- and one cable below:
- ZL-SVC-CBL50 (0.5m)** \$48.50
- ZL-SVC-CBL50-1 (1m)** \$51.00
- ZL-SVC-CBL50-2 (2m)** \$58.00

## 1 kW Low Inertia System

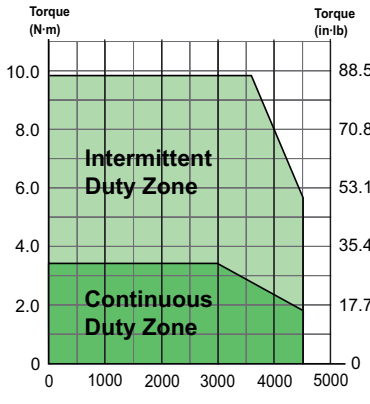

1 kW Low Inertia

Jm= Motor Inertia = .0023 lb-in-s<sup>2</sup> (0.00026 kg - m<sup>2</sup>)



Servo Drive **SVA-2100** Retired

SureServo Motor



- 2. **SVL-210** Retired
- SVL-210B (w/brake)** Retired

Motor Power Cable (1)



- 3. **SVC-PHM-010 (10')** \$160.00
- SVC-PHM-020 (20')** Retired
- SVC-PHM-030 (30')** \$290.00
- SVC-PHM-060 (60')** \$343.00

Motor Encoder Cable (1)



- 4. **SVC-EHH-010 (10')** \$153.00
- SVC-EHH-020 (20')** \$171.00
- SVC-EHH-030 (30')** Retired
- SVC-EHH-060 (60')** \$250.00

Z/PLink I/O Interface



- 5. **ZL-RTB50** \$74.00
- and one cable below:
- ZL-SVC-CBL50 (0.5m)** \$48.50
- ZL-SVC-CBL50-1 (1m)** \$51.00
- ZL-SVC-CBL50-2 (2m)** \$58.00

## 1 kW Medium Inertia System

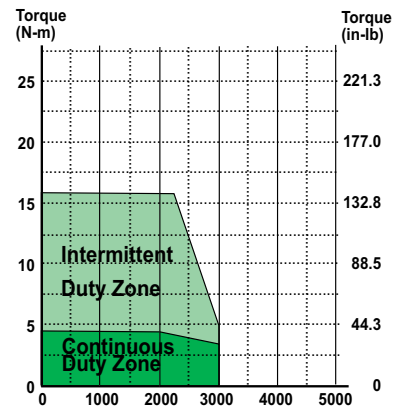

1 kW Medium Inertia

Jm= Motor Inertia = .0053 lb-in-s<sup>2</sup> (0.000598 kg - m<sup>2</sup>)



Servo Drive **SVA-2100** Retired

SureServo Motor



- 2. **SVM-210** Retired
- SVM-210B (w/brake)** Retired

Motor Power Cable (1)



- 3. **SVC-PHM-010 (10')** \$160.00
- SVC-PHM-020 (20')** Retired
- SVC-PHM-030 (30')** \$290.00
- SVC-PHM-060 (60')** \$343.00

Motor Encoder Cable (1)



- 4. **SVC-EHH-010 (10')** \$153.00
- SVC-EHH-020 (20')** \$171.00
- SVC-EHH-030 (30')** Retired
- SVC-EHH-060 (60')** \$250.00

Z/PLink I/O Interface



- 5. **ZL-RTB50** \$74.00
- and one cable below:
- ZL-SVC-CBL50 (0.5m)** \$48.50
- ZL-SVC-CBL50-1 (1m)** \$51.00
- ZL-SVC-CBL50-2 (2m)** \$58.00



# AC Servo System Configuration

For all systems:

## 2 kW Medium Inertia System

Order programming software & programming cable if needed. See [pgs. 151 & 163](#).

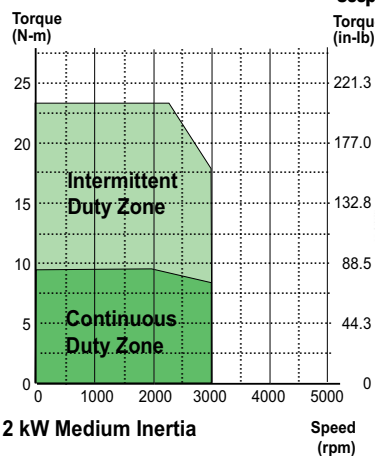

2 kW Medium Inertia

$J_m = \text{Motor Inertia} = .014 \text{ lb-in-s}^2 = (0.00158 \text{ kg} \cdot \text{m}^2)$



Servo Drive  
**SVA-2300 Retired**

**2.** SureServo Motor

**SVM-220** \$1,000.00  
**SVM-220B (w/brake)** \$1,367.00

**3.** Motor Power Cable (1)

**SVC-PHH-010 (10')** \$192.00  
**SVC-PHH-020 (20')** \$253.00  
**SVC-PHH-030 (30')** \$312.00  
**SVC-PHH-060 (60')** Retired

**4.** Motor Encoder Cable (1)

**SVC-EHH-010 (10')** \$153.00  
**SVC-EHH-020 (20')** \$171.00  
**SVC-EHH-030 (30')** Retired  
**SVC-EHH-060 (60')** \$250.00

**5.** ZIPLink I/O Interface

**ZL-RTB50** \$74.00  
and one cable below:  
**ZL-SVC-CBL50 (0.5m)** \$48.50  
**ZL-SVC-CBL50-1 (1m)** \$51.00  
**ZL-SVC-CBL50-2 (2m)** \$58.00

## 3 kW Medium Inertia System

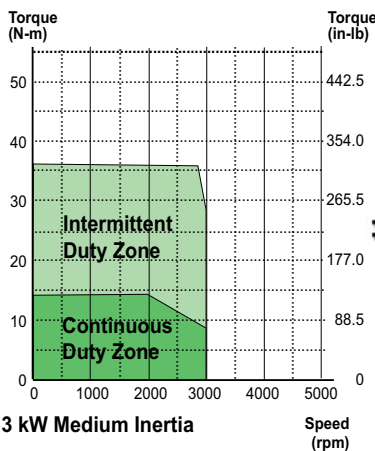

3 kW Medium Inertia

$J_m = \text{Motor Inertia} = 0.038 \text{ lb-in-s}^2 = (0.00433 \text{ kg} \cdot \text{m}^2)$



Servo Drive  
**SVA-2300 Retired**

**2.** SureServo Motor

**SVM-230** Retired  
**SVM-230B (w/brake)** Retired

**3.** Motor Power Cable (1)

**SVC-PHH-010 (10')** \$192.00  
**SVC-PHH-020 (20')** \$253.00  
**SVC-PHH-030 (30')** \$312.00  
**SVC-PHH-060 (60')** Retired

**4.** Motor Encoder Cable (1)

**SVC-EHH-010 (10')** \$153.00  
**SVC-EHH-020 (20')** \$171.00  
**SVC-EHH-030 (30')** Retired  
**SVC-EHH-060 (60')** \$250.00

**5.** ZIPLink I/O Interface

**ZL-RTB50** \$74.00  
and one cable below:  
**ZL-SVC-CBL50 (0.5m)** \$48.50  
**ZL-SVC-CBL50-1 (1m)** \$51.00  
**ZL-SVC-CBL50-2 (2m)** \$58.00



NOTE: All Motor Power Cables include brake power wires for the optional motor brake.

## SureServo Communications Cables for Multi-drop Networks

Product	Price	Description
<a href="#">SVC-MDCOM-CBL</a>	\$43.00	RS-422/485 serial communication cable for use with multidrop networks; 3ft length; IEEE 1394 plug to unterminated wires; compatible with all SureServo systems. Facilitates connection between the SureServo drive serial port and host controllers.
<a href="#">SVC-232RJ12-CBL-2</a> *	\$12.50	ZIPLink SureServo Drives cable with 6-pin RJ12 connector to a 6-pin IEEE 1394 connector, shielded, twisted pair, 2.0 meter (6.6 ft.) length. For RS-232 connection to all SureServo amplifiers.
<a href="#">SVC-485RJ12-CBL-2</a> *	\$15.00	ZIPLink SureServo amplifier communication cable, RJ12 male to 6-pin IEEE 1394 connector, shielded, twisted pair, 2.0 meter (6.6 ft.) length. Cable used in conjunction with ZL-CDM-RJ12xxx distribution module can access a compatible RS-485 device network.
<a href="#">SVC-485HD15-CBL-2</a> *	\$13.50	ZIPLink SureServo Drives cable with a HD 15-pin male to a 6-pin IEEE 1394 connector, shielded, twisted pair, 2.0 meter (6.6 ft.) length. For RS-485 connection to all SureServo amplifiers.



\* Refer to the ZIPLinks Wiring Solutions section for complete information regarding the ZIPLink cables.



# AC Servo System Software

## SureServo Pro configuration software

SureServo Pro is an optional free downloadable configuration software package for the SureServo drives. With SureServo Pro installed, the personal computer may be directly connected to the servo drive's serial port via the PC's RS-232 serial port\*. A six-foot configuration cable (SVC-PCCFG-CBL, \$37.50) is available to make the connection between the drive serial port and PC DB-9 serial port simple.

*\*Note: Use our [USB-RS232](#) converter cable in conjunction with the [SVC-PCCFG-CBL](#) cable on PCs having only USB ports.*

### Features

- Quick Start - The basic setup when you have limited time and just want to get up and running ASAP.
- Maintenance keypad allows the user to operate the servo system from the PC. This is a great aid during start-up to allow the servo to perform some basic motion and to check the I/O.
- Detailed - The complete setup for all the drive parameters
- Tune and check the servo response live using the scope feature.
- Upload and download the drive setup. Save the drive setup as a file for future use.
- Edit the drive setup
- View all drive faults
- Trend drive variables in real time

## Parameter views

The SureServo Pro configuration tool logically organizes over 165 servo drive parameters into five tabbed groups. Each parameter has a factory default that usually allows the servo to run "out-of-the-box".

The parameters can be easily changed with available options or setting ranges displayed. Tuning modes and parameters can also be changed using SureServo Pro. After the parameters have been defined, the complete setup can be stored and archived. Drive configurations can be uploaded, edited, saved, and downloaded as often as necessary.

### Parameter View Example Screen - Basic Parameters

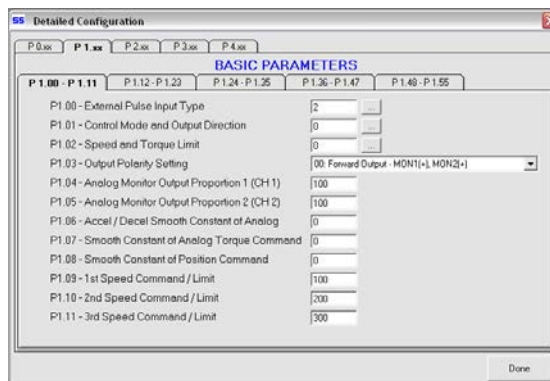

## SureServo Software and Configuration Cables

Product	Price	Description
<b><a href="#">SV-PRO</a></b>	Free	SureServo Pro configuration software for use with all SureServo servo systems. FREE download from <a href="http://www.sureservo.com">www.sureservo.com</a> or <a href="http://www.automationdirect.com">www.automationdirect.com</a> websites.
<b><a href="#">SVC-PCCFG-CBL</a></b>	\$37.50	Six-foot RS-232 communications cable; connects servo drive serial port to PC DB-9 serial port. For PCs having only USB ports, use our <a href="#">USB-RS232</a> converter cable in conjunction with the <a href="#">SVC-PCCFG-CBL</a> cable.
<b><a href="#">SVC-485CFG-CBL-2</a></b>	\$18.50	ZIPLink SureServo amplifier configuration cable, 6-pin IEEE 1394 connector to RJ45 connector, shielded, twisted pair, 2.0 meter (6.6 ft.) length. Use this cable in conjunction with our <a href="#">USB-485M</a> serial adapter to connect any SureServo amplifier to a PC. Eliminates the need to reprogram networked servo drives from RS485 to RS232 when connecting to a PC.

\* Refer to the ZIPLinks Wiring Solutions section for complete information regarding ZIPLink cable [SVC-485CFG-CBL-2](#).

# AC Servo System Software

## SureServo Pro configuration software - Parameter views (continued)

### Parameter View Example Screen - Monitor Parameters

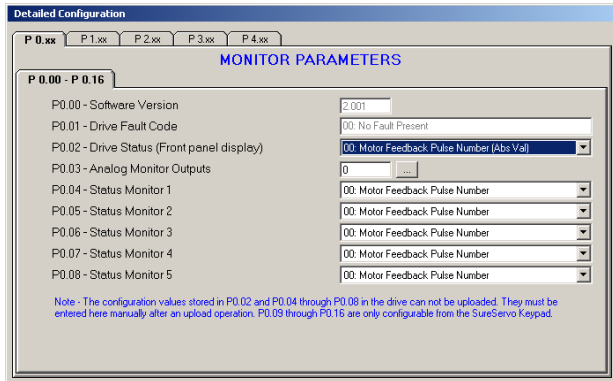

## Maintenance screen

A maintenance keypad allows the user to operate the servo system from the PC. This is a great aid during start-up to allow the servo to perform some basic motion and to check the I/O.

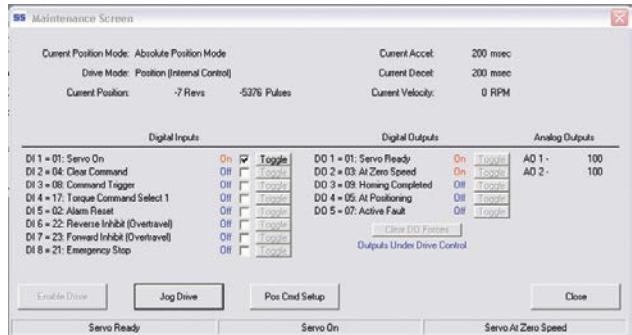

### Parameter View Example Screen - Extended Parameters

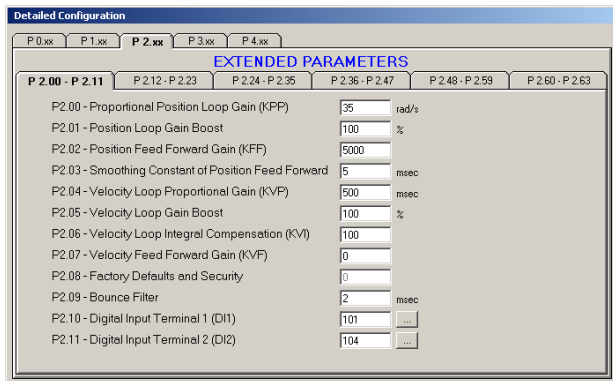

## Scope

SureServo Pro includes a powerful scope function that allows the user to have as many as three channels of data displayed simultaneously. Each channel has a drop-down table to select the data to be displayed. The scope also has a trigger mode and timebase selection. This function is a valuable tool for tuning SureServo drives.

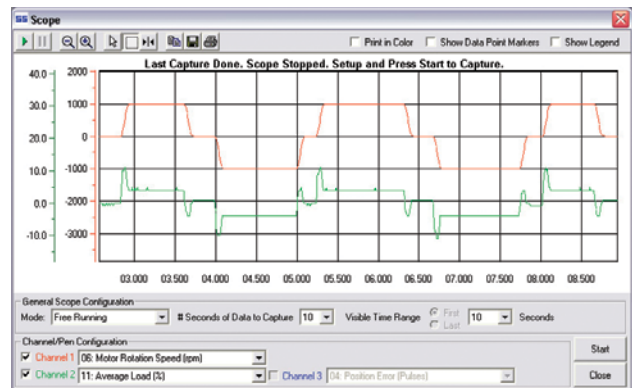

### Parameter View Example Screen - Communication Parameters

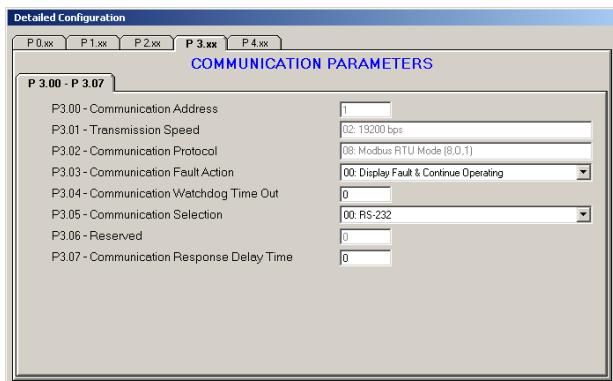

# AC Servo Drive Specifications

## Servo drive overview

### Power On LED

Main power is ON

### Control Power Terminal

Single-phase power 230 VAC, 50/60 Hz is connected to L1 and L2

### Main Power Terminal

Three-phase power 230 VAC, 50/60 Hz is connected to R, S and T

(Single-phase power 230 VAC 50/60 Hz may be connected to R and S for the low inertia systems)

### Motor Output Terminal

The servo motor power cable is connected to U, V and W. Use our factory made and tested cables available in 10, 20, 30 or 60 foot lengths for easy connection.

### Regenerative Resistor Terminal

1. When the internal regenerative resistor is used, the P and D terminal are connected together while the P and C connection is left open.
2. When an external regenerative resistor is used, it is connected across the P and C terminals while the P and D connection is left open. Use our factory approved resistors for "sure" results.

### LED Display

The LED display has 5 full digits and is used to indicate servo status and alarms

### Keypad

#### Five Function keys:

- MODE: Press to select or change mode  
 NEXT: Press to shift left  
 UP: Press to increase values  
 DOWN: Press to decrease values  
 ENTER: Press to enter value

### I/O Interface

50-pin connector for interfacing the host controller (such as DirectLOGIC PLC) and other types of I/O signals.

Use our ZIPLink kit which provides DIN-rail mounted screw terminals for easy connection.

- Command inputs:
  - Pulse and Direction Encoder
  - Follower Analog Velocity/Torque
- (8) Digital Inputs
- (5) Digital Outputs
- (2) Analog Monitors
- Encoder Output (scalable)  
A+, A-, B+, B-, Z+, Z-

### Encoder Interface

20-pin connector for interfacing the servo motor encoder. Use our factory-made and tested cable available in 10, 20, 30 or 60 foot lengths for easy connection.

### Serial Communication Interface

6-pin RS-485/422/232 interface to personal computer with SureServo Pro set-up software or host controller with Modbus RTU/ASCII protocol. Use our factory-made cables for easy connection to the PC or the host controller.

### Ground Terminals



## SureServo systems run "out-of-the-box"... but may be reconfigured for many applications!

The SureServo drives are fully digital and include over 165 programmable parameters. For convenience, the parameters are grouped into five categories:

1. Monitor parameters
2. Basic parameters
3. Extended parameters
4. Communication parameters
5. Diagnostic parameters.

All parameters have commonly used default values which allow you to operate the SureServo system "out-of-the-box". However, the programmability and large variety of parameters make the SureServo systems suitable for a very broad range of applications, including almost all types of general purpose industrial machinery such as assembly, test, packaging, machine tool, and robotics.



# AC Servo Drive Specifications

## Servo drive specifications

General Drive Specifications	
<b>Permissible Frequency</b>	50/60 Hz $\pm$ 5%
<b>Encoder Resolution / Feedback Resolution</b>	2500 lines / 10000 ppr
<b>Control of Main Circuit</b>	SVPWM (Space Vector Pulse Width Modulation) Control
<b>Tuning Modes</b>	Easy / Auto / Manual
<b>Dynamic Brake</b>	Built-in control
<b>Analog Monitor Outputs (2)</b>	Monitor signal can be set by parameters (Output voltage range: $\pm$ 8V; Resolution: 12.8 mV/count)
<b>8 Programmable Digital Inputs (45 selectable functions)</b>	Servo enable, Alarm reset, Gain switching, Pulse counter clear, Fault stop, CW/CCW over-travel Internal parameter selection, Torque limit activation, Velocity limit activation, Control mode selection
<b>Scalable Encoder Output</b>	Encoder signal output A, /A, B, /B, Z /Z, Line Driver
<b>5 Programmable Outputs (9 selectable indicators)</b>	Servo ready, Servo On, Low velocity, Velocity reached, In Position, Torque limiting, Servo fault, Electromagnetic brake control, Home search completed
<b>Communication Interface</b>	RS-232 / RS-485 / RS-422 / Modbus ASCII & RTU up to 115k Baud
<b>Protective Functions</b>	Overcurrent, Overvoltage, Undervoltage, Overload, Excessive velocity/position error, Encoder error, Regeneration error, Communication error
<b>Installation Site</b>	Indoor location (free from direct sunlight), no corrosive liquid and gas (far away from oil mist, flammable gas, dust)
<b>Altitude</b>	1000m [3281 ft] above sea level – maximum
<b>Operating Temperature</b>	0 to 55 °C [32 to 131 °F] (If operating temperature is above 55°C, forced cooling is required). For long-term reliability, the ambient temperature of SureServo systems should be under 45°C (113°F).
<b>Storage Temperature</b>	-20° to 65°C (-4° to 149°F)
<b>Humidity</b>	0 to 90% (non-condensing)
<b>Vibration</b>	9.81 m/s <sup>2</sup> (1G) less than 20Hz, 5.88 m/s <sup>2</sup> (0.6G) 20 to 50 Hz
<b>Protection</b>	IP 20
<b>Agency Approvals</b>	CE; UL Certified (U.S. and Canada)





# AC Servo Drive Specifications

## Servo drive specifications (continued)

Model and Mode Specific Drive Specifications									
AC Servo Model		SVA-2040			SVA-2100			SVA-2300	
Price		Retired			Retired			Retired	
Voltage Phase		Single-phase or Three-phase						Three-phase	
Voltage and Frequency Range		3-phase: 170~255 VAC @ 50/60 Hz $\pm 5\%$ ; 1-phase: 200~255 VAC @ 50/60 Hz $\pm 5\%$						170~255 VAC @ 50/60 Hz $\pm 5\%$	
Main Circuit Input Current	Single Phase	3.4A @ 400W			8.0A @ 1kW			-	
	Three Phase	2.6A @ 400W			6.2A @ 1kW			13.6A @ 3kW	
Main Circuit Inrush Current		44A			77A			87A	
Main Circuit Power Cycling		Maximum 1 power cycle per minute							
Control Circuit Current and Voltage		43 mA @ 200~255 VAC, 1 phase							
Control Circuit Inrush Current		32A maximum							
Cooling System		Natural Air Circulation				Internal Cooling Fan			
Drive Heat Loss *	Motor driven *	SVL-201(B)	SVL-202(B)	SVL-204(B)	SVL-207(B)	SVL-210(B)	SVM-210(B)	SVM-220(B)	SVM-230(B)
	Heat Loss	12W	15W	20W	35W	45W	50W	75W	80W
Weight		1.5 kg [3.3 lb]			2kg [4lb]			3kg [7lb]	
Position Control Mode	Max. Input Pulse Frequency		Max. 500 kpps (Line driver); Max. 200 kpps (Open collector)						
	Pulse Type		Pulse + Direction, A phase + B phase Quadrature, CCW pulse + CW pulse						
	Command Source		External pulse train / Onboard indexer						
	Smoothing Strategy		Low-pass and P-curve filter						
	Electronic Gear		Electronic gear N/M multiple; N: 1~32767, M: 1~32767(1/50<N/M<200)						
	Torque Limit Operation		Set by parameters or by analog input						
	Feed Forward Compensation		Set by parameters						
Velocity Control Mode	Analog Input Command	Voltage Range		Bipolar $\pm 10$ VDC					
		Input Resistance		10 k					
		Time Constant		2.2 $\mu$ s					
		Resolution		(Varies with input voltage) 13 bits @ 0V~1V; 13~10 bits @ 1V~2V; 10 bits @ 2V~10V					
	Speed Control Range		1:5000						
	Command Source		External analog signal / Onboard indexer						
	Smoothing Strategy		Low-pass and S-curve filter						
	Torque Limit Operation		Set by parameters or via analog input						
	Frequency Response Characteristic		Maximum 450 Hz						
	Speed Accuracy (at rated rotation speed)		0.01% or less at 0 to 100% load fluctuation						
0.01% or less at $\pm 10\%$ power fluctuation									
0.01% or less at 0 to 50°C ambient temperature fluctuation									
Torque Control Mode	Analog Input Command	Voltage Range		Bipolar $\pm 10$ VDC					
		Input Resistance		10 k $\Omega$					
		Time Constant		2.2 $\mu$ s					
		Resolution		10 bits					
	Permissible Time for Overload		8 sec. under 200% rated output						
	Command Source		External analog signal / Onboard indexer						
	Smoothing Strategy		Low-pass filter						
Speed Limit Operation		Set by parameters or via analog input							

\* Drive heat loss varies depending upon which motor is connected to the drive.



# AC Servo Motor Specifications

## Servo motor overview

### Motor Power and Brake Connector

1-foot cable with 6-position connector (Not liquid tight)

750W and below

### Encoder Connector

1-foot cable with 9-position connector (Not liquid tight)



### Without Shaft Seal

(not liquid tight)

IP65 Housing

### Low Inertia Motors

- 100W 40 mm flange
- 200W 60 mm flange
- 400W 60 mm flange
- 750W 80 mm flange

### Keyless Shafts

- 100W 8 mm diameter
- 200W 14 mm diameter
- 400W 14 mm diameter
- 750W 19 mm diameter

All SureServo motors have keyless shafts for use with servo-grade clamp or compression couplings.

### Motor Power and Brake Connector

(Liquid tight when using AutomationDirect cables)

### Encoder Connector

(Liquid tight when using AutomationDirect cables)

1 kW and above

### Low and Medium Inertia Motors

- Low Inertia Model
- 1 kW 100 mm flange
- Medium Inertia Models
- 1 kW 130 mm flange
  - 2 kW 180 mm flange
  - 3 kW 180 mm flange

IP65 Housing

### Keyless Shafts

- Low Inertia Model
- 1 kW 22 mm diameter
- Medium Inertia Models
- 1 kW 22 mm diameter
  - 2 kW 35 mm diameter
  - 3 kW 35 mm diameter

### With Shaft Seal

(liquid tight)





# AC Servo Motor Specifications

Motor Specifications												
Inertia Range		Low					Medium					
Model Name: Sxx-xxx		SVL-201	SVL-202	SVL-204	SVL-207	SVL-210	SVM-210	SVM-220	SVM-230			
Price		Retired	Retired	Retired	Retired	Retired	Retired	\$1,000.00	Retired			
Model with brake: Sxx-xxxB		SVL-201B	SVL-202B	SVL-204B	SVL-207B	SVL-210B	SVM-210B	SVM-220B	SVM-230B			
Price		Retired	Retired	Retired	Retired	Retired	Retired	\$1,367.00	Retired			
Rated output power	W	100	200	400	750	1000	1000	2000	3000			
Rated torque	N·m	0.32	0.64	1.27	2.39	3.3	4.8	9.4	14.3			
	lb·in	2.8	5.7	11.2	21.2	29.2	42.5	83.2	126.6			
Maximum torque	N·m	0.95	1.91	3.82	7.16	9.9	15.7	23.5	35.8			
	lb·in	8.4	16.9	33.8	63.4	87.6	138.9	208.0	316.8			
Rated speed	rpm	3000					2000					
Max. speed	rpm	5000			4500		3000					
Rated current	A	1.1	1.7	3.3	5.0	6.8	5.6	13.1	17.4			
Max. current	A	3.0	4.9	9.3	14.1	18.7	17.6	31.4	42.3			
Drive input current	1 phase A	1.0	1.7	3.4	5.9	8.0	8.0	-	-			
	3 phase A	0.8	1.3	2.6	4.7	6.2	6.2	9.1	13.6			
Max. radial shaft load	N	78.4	196		343	490		784				
	lb	18	44		77	110		176				
Max. thrust shaft load	N	39.2	68.6		98			392				
	lb	9	15		22			88				
Brake	Voltage	VDC										
	Current	ADC		0.21		0.38		0.4		0.75		
	Holding Torque	N·m	0.32		1.27		2.55		9.3		7.5	
		lb·in	2.83		11.24		22.57		82.3		66.38	
Rotor inertia w/o brake	kg·m <sup>2</sup>	0.03E-4	0.18E-4	0.34E-4	1.08E-4	2.6E-4	5.98E-4	15.8E-4	43.3E-4			
	lb·in·s <sup>2</sup>	0.27E-4	1.59E-4	3.0E-4	9.56E-4	23.0E-4	52.9E-4	139.8E-4	383.2E-4			
Rotor inertia with brake	kg·m <sup>2</sup>	0.06E-4	0.28E-4	0.44E-4	1.32E-4	3.1E-4	8.8E-4	27.8E-4	56.3E-4			
	lb·in·s <sup>2</sup>	0.53E-4	2.48E-4	3.9E-4	11.7E-4	27.4E-4	77.9E-4	246.0E-4	498.3E-4			
	ms	0.6	0.9	0.7	0.6	1.7	1.4	1.6	0.9			
Static friction torque	N·m	0.02	0.04		0.08	0.49	0.29	0.98				
Torque constant-KT	N·m/A	0.32	0.39	0.4	0.5	0.56	0.91	0.77	0.86			
Voltage constant-KE	V/rpm	33.7E-3	41.0E-3	41.6E-3	52.2E-3	58.4E-3	95.71E-3	81.1E-3	90.5E-3			
Armature resistance	Ω	20.3	7.5	3.1	1.3	2.052	1.98	0.6	0.162			
Armature inductance	mH	32	24	11	6.3	8.4	13.2	6.1	2.3			
Electrical time constant	ms	1.6	3.2	3.2	4.8	4.1	6.7	10.1	14.2			
Motor Type	Brushless, AC, permanent magnet [Neodymium (Nd), Iron (Fe), Boron (B)]											
Insulation class	Class F											
Insulation resistance	>100 MΩ, 500 VDC											
Insulation strength	1500 VAC, 50 Hz, 60 seconds											
Ambient temperature range	0 to 40°C (32°F to 104°F)											
Operating temperature (measured case temperature)	70°C (158°F)											
Maximum operating temperature (measured case temperature)	70°C + 40°C = 110°C (230°F)											
Storage temperature	-20 to 65°C (-4 to 149°F)											
Operating humidity	20 to 90% RH (non-condensing)											
Storage humidity	20 to 90% RH (non-condensing)											
Vibration / Shock	2.5G / 5.0G											
Environmental rating	IP65 motor body; IP40 shaft; IP20 connector					IP65 (requires SureServo cables)						
Weight without brake	kg	0.5	0.9	1.3	2.5	4.7	4.8	12.0	17.0			
	lb	1.1	1.98	2.87	5.5	10.36	10.58	26.46	37.48			
Weight with brake	kg	0.7	1.4	1.8	3.4	6.3	7.5	19.0	24.0			
	lb	1.54	3.09	3.97	7.5	13.89	16.53	41.89	52.9			
Agency Approvals	CE; UL recognized (U.S. and Canada)											

NOTE: U.S. customary units are for reference only.

## Standard wiring examples



This wiring diagram shows basic wiring only, and additional wiring configurations are possible for some I/O. Refer to the "Installation and Wiring" chapter of the User Manual for more detailed wiring information.

### Position (Pr & Pt) Control Modes

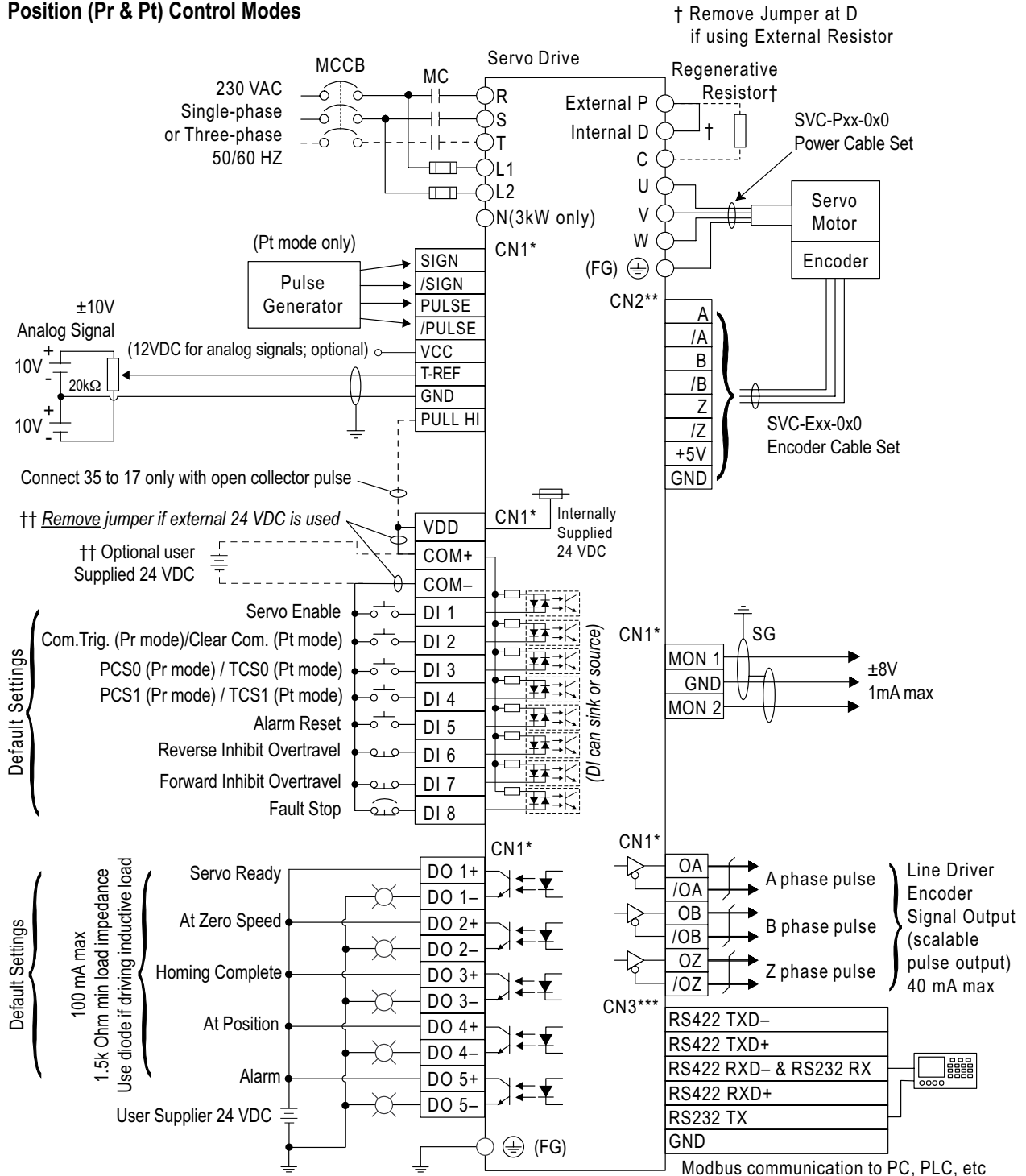

\* Use connection kit part #s ZL-RTB50 & ZL-SVC-CBL-50(-x) for CN1 terminal connections.  
 \*\* Use cable part # SVC-Exx-0x0 for CN2 terminal connections.  
 \*\*\* Use cable part # SVC-MDCOM-CBL for CN3 terminal Modbus network connections.

## Standard wiring examples (continued)



This wiring diagram shows basic wiring only, and additional wiring configurations are possible for some I/O. Refer to the "Installation and Wiring" chapter of the User Manual for more detailed wiring information.

### Velocity and Torque Control Modes

† Remove Jumper at D if using External Resistor

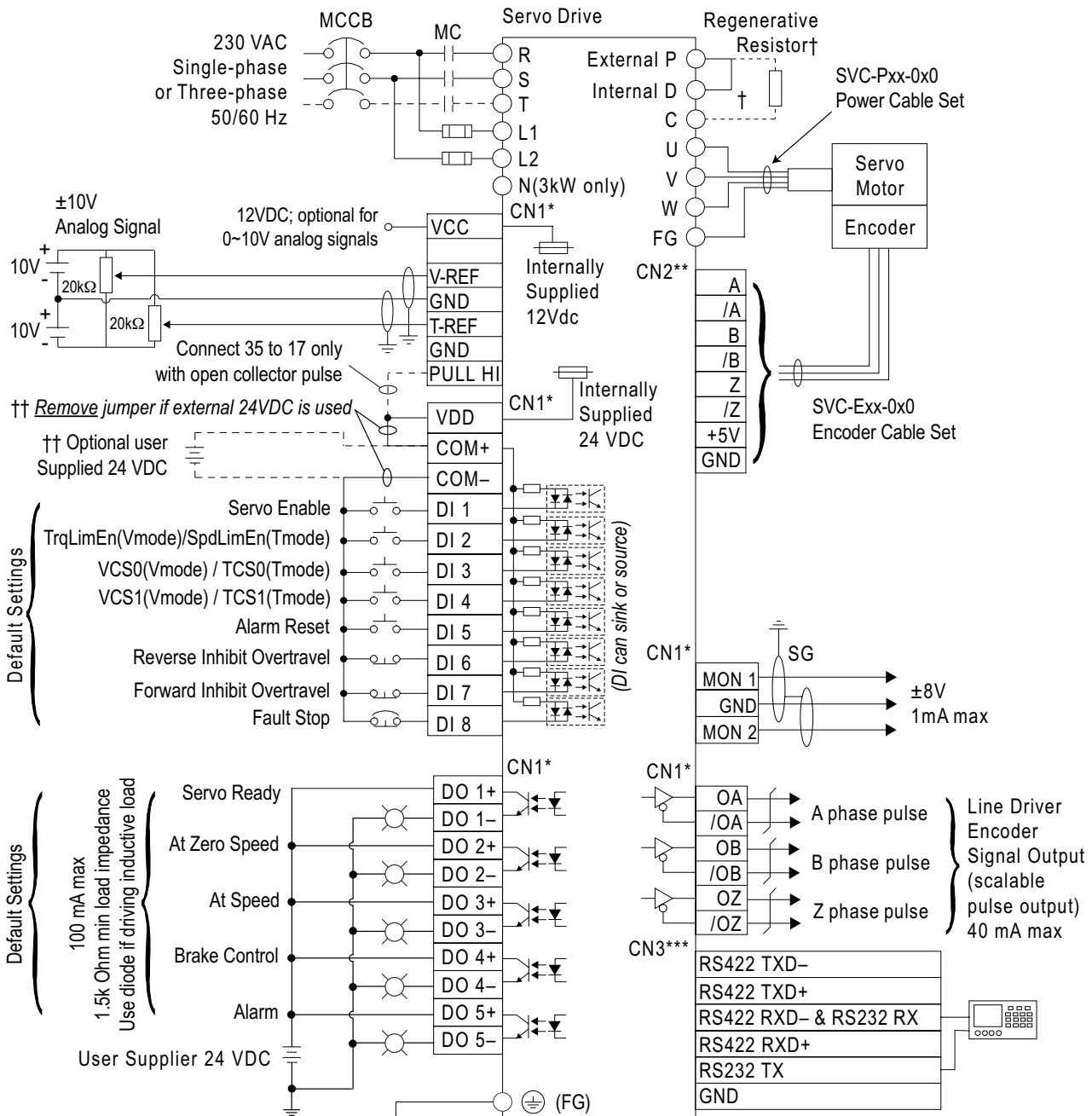

\* Use connection kit part #s ZL-RTB50 & ZL-SVC-CBL-50(-x) for CN1 terminal connections.

\*\* Use cable part # SVC-Exx-0x0 for CN2 terminal connections.

\*\*\* Use cable part # SVC-MDCOM-CBL for CN3 terminal Modbus network connections.



# AC Servo System Dimensions

## Servo drive dimensions

**SVA-2040**



Recommended user supplied mounting screw is M6.  
Tighten to 14 kgf-cm (1.37 N-m).

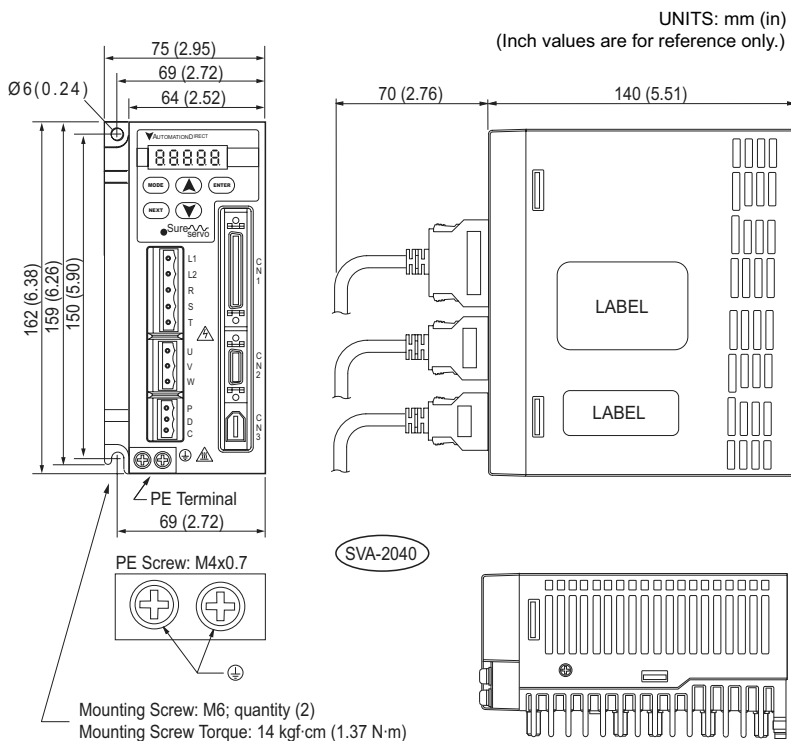

**SVA-2100**



Recommended user supplied mounting screw is M6.  
Tighten to 14 kgf-cm (1.37 N-m).

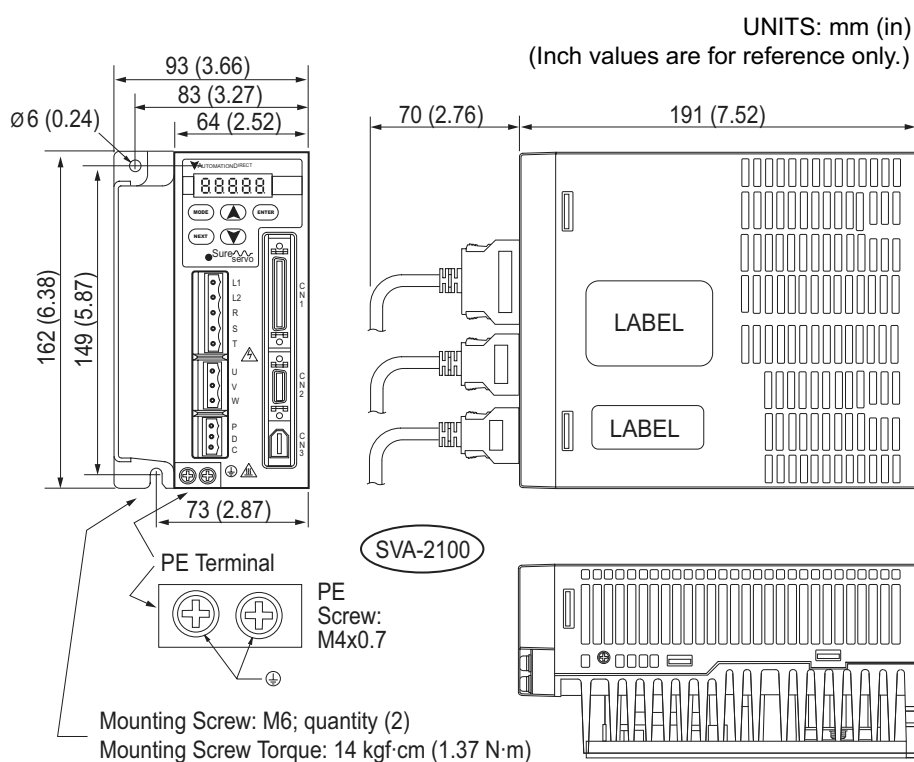



# AC Servo System Dimensions

## Servo drive dimensions (continued)

**SVA-2300**



Recommended user supplied mounting screw is M6. Tighten to 14 kgf-cm (1.37 N-m).

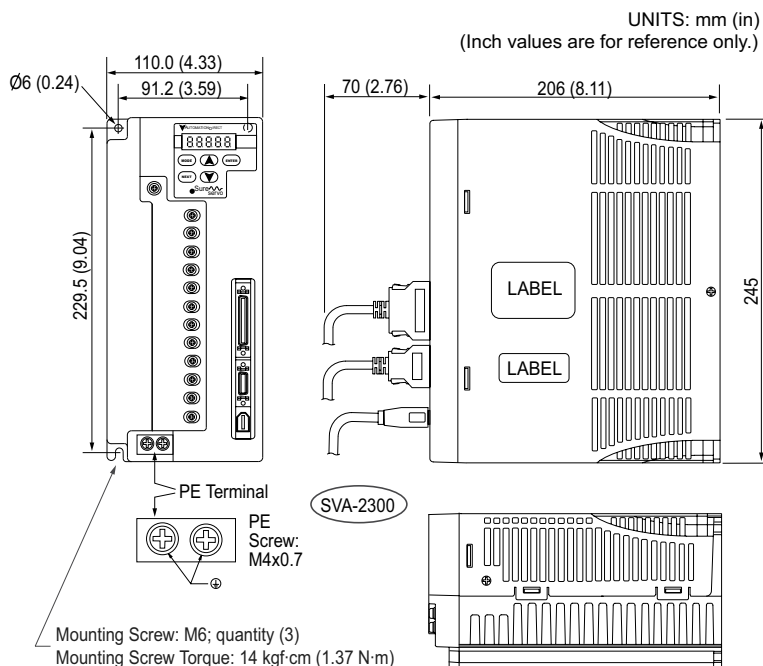

## Servo motor dimensions

Low inertia models **SVL-201(B)**, **SVL-202(B)**, **SVL-SVL-204(B)**, **SVL-207(B)**

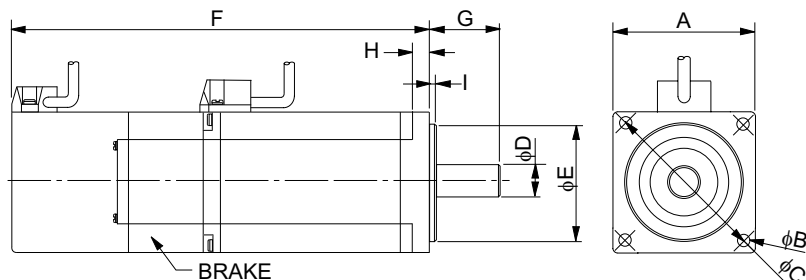

SureServo® Motor Dimensions – 100W-750W Low Inertia				
Dimension	SVL-201(B)	SVL-202(B)	SVL-204(B)	SVL-207(B)
A	40 [1.575]	60 [2.362]	80 [3.15]	
B	4.5 [0.1772]	5.5 [0.2165]	6.6 [0.2598]	
C	46 [1.811]	70 [2.756]	90 [3.543]	
D	8 +0.0/-0.009 (8h6)	14 +0.0/-0.011 (14h6)	19 +0.0/-0.013 (19h6)	
E	30 +0.0/-0.021 (30h7)	50 +0.0/-0.025 (50h7)	70 +0.0/-0.030 (70h7)	
F (w/o brake)	100.1 [3.941]	102.4 [4.032]	124.4 [4.898]	135 [5.315]
F (with brake)	135.7 [5.343]	137 [5.394]	159 [6.26]	171.6 [6.756]
G	25 [0.98]	30 [1.18]	35 [1.38]	
H	5 [0.197]	6 [0.236]	8 [0.315]	
I	2.5 [0.098]	3 [0.118]		
Cable length	300mm (12 inches)			

UNITS: mm [in]. (Inches are for reference only; not included on diameter dimensions for accuracy.)



# AC Servo System Dimensions

## Servo motor dimensions (continued)

### Low inertia models SVL-210(B)

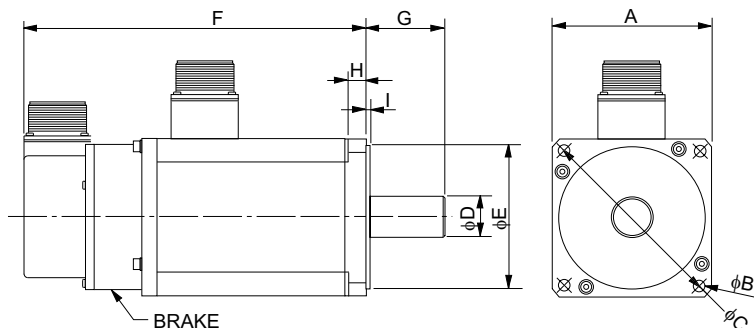

SureServo® Motor Dimensions -1000W Low Inertia	
Dimension	SVL-210(B)
A	100 [3.937]
B	9 [0.3543]
C	115 +0.2/-0.2 [4.528]
D	22 +0.0/-0.013 (22h6)
E	95 +0.0/-0.035 (95h7)
F (w/o brake)	158 [6.22]
F (with brake)	190 [7.48]
G	45 [1.77]
H	17 [0.669]
I	7 [0.28]

UNITS: mm [in] (Inches are for reference only; not included on diameter dimensions for accuracy.)

### Medium inertia models SVM-210(B), SVM-220(B), SVM-230(B)

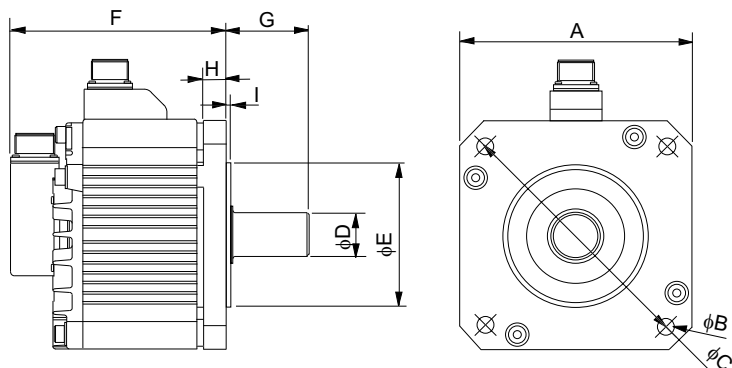

SureServo® Motor Dimensions -1000W-3000W Medium Inertia			
Dimension	SVM-210(B)	SVM-220(B)	SVM-230(B)
A	130 [5.118]	180 [7.087]	
B	9 [0.3543]	13.5 [0.5315]	
C	145 +0.2/-0.2 [5.709]	200 +0.2/-0.2 [7.874]	
D	22 +0.0/-0.013 (22h6)	35 +0.0/-0.016 (35h6)	
E	110 +0.0/-0.035 (110h7)	114.3 +0/-0.035 (114.3h7)	
F (w/o brake)	143 [5.63]	164 [6.457]	212 [8.35]
F (with brake)	181 [7.126]	213 [8.386]	258 [10.16]
G	55 [2.17]	75 [2.95]	
H	15 [0.591]	20 [0.787]	
I	4 [0.157]		

UNITS: mm [in] (Inches are for reference only; not included on diameter dimensions for accuracy.)





# AC Servo System Accessories

## Accessories

### External Regeneration Resistors

Use external resistors to provide additional regenerative capacity and to dissipate heat away from the servo drive.

Part Number	Resistance	SureServo Drives	Price
<b>GS-25P0-BR</b>	40Ω	SVA-2040	Retired
<b>GS-2010-BR-ENC</b>	20Ω	SVA-2100, SVA-2300	\$358.00



Resistor GS-25P0-BR

### AC Line Filters

Input EMI filters reduce electromagnetic interference or noise on the input side of the servo drive. They are required for CE compliance and recommended for installations prone to or sensitive to electromagnetic interference.

SureServo® Drives	AC Input Power	EMI Filter Rating	EMI Filter Part Number	Price
<b>SVA-2040</b>	Single-Phase	250V, 1-phase, 20A	<a href="#">20DRT1W3S</a>	\$73.00
	Three-Phase	250V, 3-phase, 10A	<a href="#">10TDT1W4C</a>	\$85.00
<b>SVA-2100</b>	Single-Phase	250V, 1-phase, 20A	<a href="#">20DRT1W3S</a>	\$73.00
	Three-Phase	250V, 3-phase, 10A	<a href="#">10TDT1W4C</a>	\$85.00
<b>SVA-2300</b>	Three-Phase	250V, 3-phase, 26A	<a href="#">26TDT1W4C</a>	Retired



AC Line Filter 10TDT1W4C



Note: These EMI Filters are electrically compatible with the SureServo drives. However, they are intended to be mounted next to the servo drive. Do not mount the filter under the drive. The drive mounting holes on these units are intended to be used only with AutomationDirect's line of VFDs.

### Edison Fuses & Fuji Contactors

SureServo® Drives	Input Type	Input Voltage	Edison Fuse - Class CC	Price*	Contactor**	Price
<b>SVA-2040</b>	Main Input Power	230V 3-Phase	<a href="#">HCTR4</a>	\$158.00	SC-E02-xxx	varies
<b>SVA-2100</b>			<a href="#">HCTR7-5</a>	\$176.00	SC-E03-xxx	varies
<b>SVA-2300</b>			<a href="#">HCTR15</a>	\$149.00	SC-E04-xxx	varies
<b>SVA-2040</b>	Main Input Power	230V 1-phase	<a href="#">HCTR4</a>	\$158.00	SC-E02-xxx	varies
<b>SVA-2100</b>			<a href="#">HCTR10</a>	\$158.00	SC-E03-xxx	varies
<b>SVA-2040</b> <b>SVA-2100</b> <b>SVA-2300</b>	Control Input Power	230V 1-phase	<a href="#">HCTR2-5</a>	\$162.00		

\* Fuses are sold in packages of 10.

\*\* Note: For contactors, xxx = coil voltage (for example, SC-E02P-220VAC).



Fuji Contactor SC-E02-xxx



Edison Fuse HCTRx

### SureServo Connector Kit (replacement)

This kit contains replacement input, output, and brake connectors for SureServo drives.

Part Number	Description	SureServo Drives	Price
<b>SVA-CON-1</b>	SureServo connector kit, replacement, includes (1) input power connector, (1) output power connector and (1) brake resistor connector.	SVA-2040 SVA-2100	\$22.00



SVA-CON-1