



Linear Motion Products

Product Overview

Actuator Overview

SureMotion linear motion offers both motor-ready actuator assemblies, and a versatile assortment of sliding components and accessories to provide a wide variety of motion control solutions.

Linear Slide Actuator Comparisons

Actuator Series Comparisons						
Actuator Series	Actuator Type	Drive Type	Max Load Capacity (lb)	Max Speed (in/s)	Travel (in)	Relative Price
LARSD2	Twin Round Shaft	Ball Screw	920	6	12, 24	\$\$\$\$
LACP2	Compact Slide	Lead Screw	125	20	6, 12, 24, 36	\$\$
LAVL2	Value Slide	Lead Screw	110	15	6, 12, 18, 24	\$

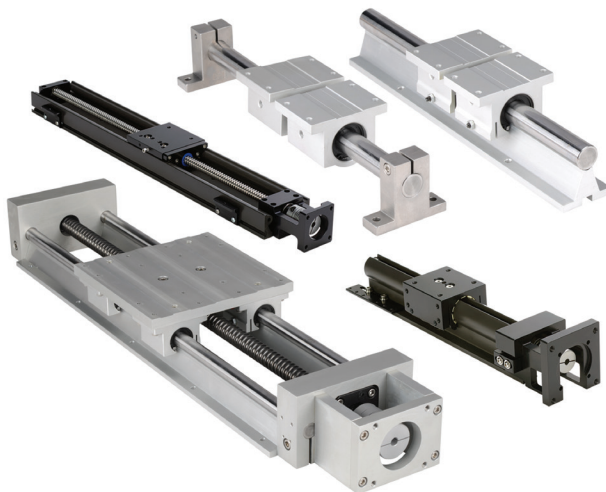

Available Multi-Axis Configurations

X-Y Axis Configurations

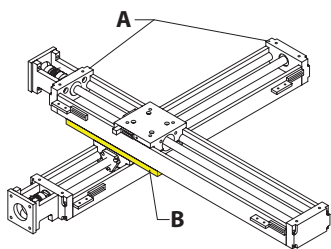

A. (2) LAVL2-60Txxxx
B. (1) LAVLACC-004

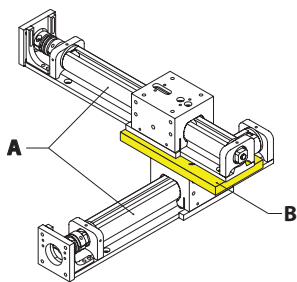

A. (2) LACP2-16Txxxx
B. (1) LACPACC-004

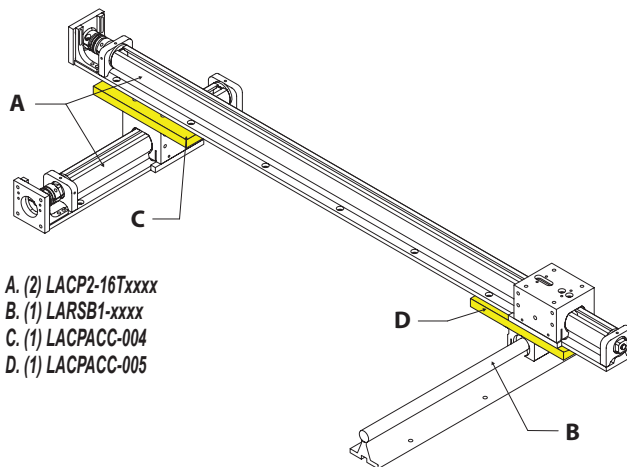

A. (2) LACP2-16Txxxx
B. (1) LARSB1-xxxx
C. (1) LACPACC-004
D. (1) LACPACC-005

X-Z Axis Configuration

X-Y-Z Axis Configuration

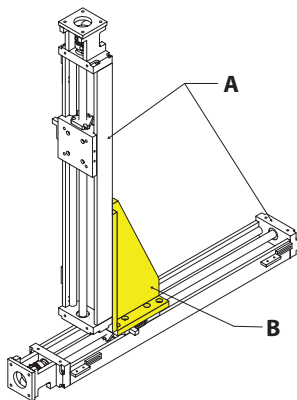

A. (2) LAVL2-60Txxxx
B. (1) LAVLACC-005

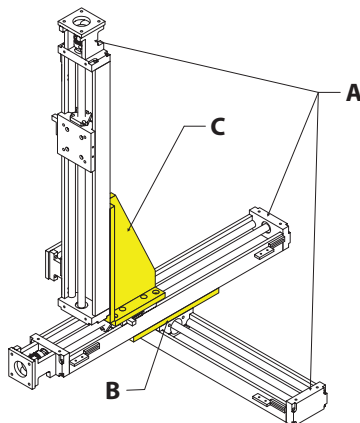

A. (3) LAVL2-60Txxxx
B. (1) LAVLACC-004
C. (1) LAVLACC-005

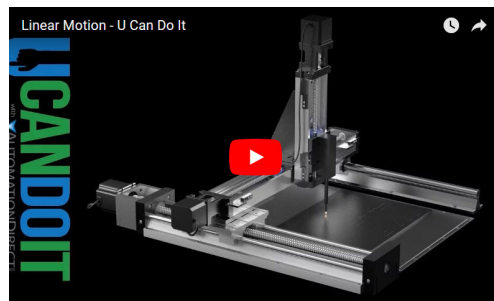

Click on the above video link for a short visual example of how our products can be used.



Linear Motion Products

Twin Round Shaft Slide Actuators

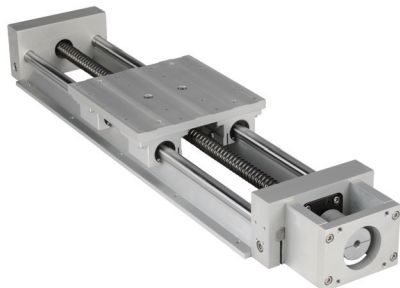

LARSD2-08T12BP2C

Description

Continuously-supported round rail slide with ball screw actuation provides a very robust precision linear motion. Units are complete except for a drive motor.

Features

- High-accuracy ball screw
- Continuously-supported guide rails
- Replacement components available
- Ready for NEMA 23 motor
- AISI 1566 Carbon Steel, 60 RC Round Shafts
- AISI 1045 Carbon Steel , 56 RC Ball Screw

Applications

- Positioning systems
- Heavy loads

Twin Round Shaft Slide Actuator Specifications									
Part Number	Price	Drive Type	Drive Pitch	Drive Screw Efficiency (%)	Payload Inertia Factor (in ²)	Constant System Inertia (lbm-in ²)	Travel	Weight (lb)	Fits Motor
LARSD2-08T12BP2C	\$3,157.00	Ball screw	0.2 in	83	0.001	0.11	12in	10.5	NEMA 23
LARSD2-08T24BP2C	\$3,409.00					0.16	24in	14.0	

System Inertia Calculation:

- To calculate the inertia reflected to the motor in a particular actuator, multiply the carriage payload by the payload inertia factor and then add the constant system inertia value for that actuator. The constant system inertia value for each system includes the inertia of the shaft coupler, carriage, and lead/ball screw.
- The payload must be in units of lb_m.

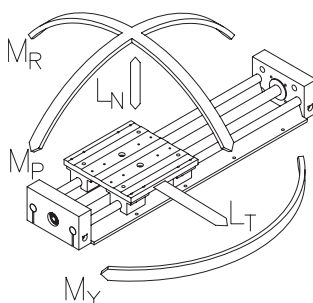

Load rating diagram

Twin Round Shaft Slide Actuator Load/Moment Ratings							
Part Number	Actuator Thrust	Load (lb)			Moment (lb-in)		
		Normal – LN		Transverse	Roll	Pitch	Yaw
		Down	Up	LT	MR	MP	MY
LARSD2-08TxxBP2C	200	920	644	920	1046	1210	1730



Linear Motion Products

Twin Round Shaft Slide Actuators

Dimensions (in [mm])

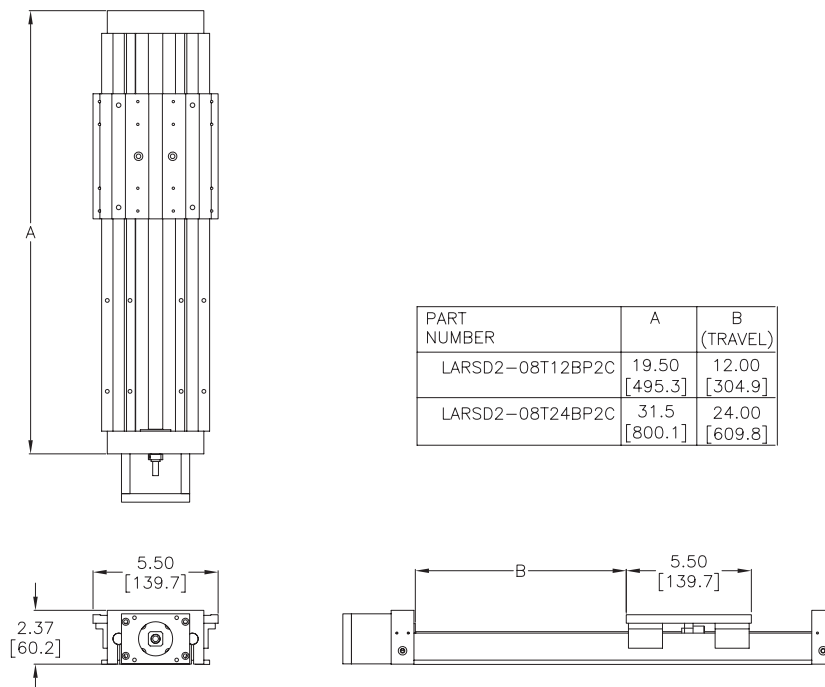

LARSD2-08TxxBP2C

See our website www.AutomationDirect.com for complete Engineering drawings.

Accessories

Twin Round Shaft Slide Actuator Accessories			
Part Number	Price	Description	Weight (lb)
LARSACC-010	\$31.50	SureMotion linear ball bushing, open type, 1/2 inch inside diameter, with seals, self-aligning.	0.5
LARSACC-013*	\$842.00	SureMotion repair kit, for use with LARSD2-08T12BP2C actuators. Ballscrew, ballnut, end bearings and grease tube included.	3.0
LARSACC-014*	\$829.00	SureMotion repair kit, for use with LARSD2-08T24BP2C actuators. Ballscrew, ballnut, end bearings and grease tube included.	5.0
LARSACC-015*	\$316.00	SureMotion motor adapter, NEMA 23 frame. For use with LARSD2-08 series actuators. 1/4 x 1/4 inch coupler included.	1.0
LARSACC-016*	\$380.00	SureMotion motor adapter, NEMA 34 frame. For use with LARSD2-08 series actuators. 1/2 x 1/4 inch coupler included.	1.0

* Repair kits and NEMA 23/34 motor adapter contain replacement components that are the same as the original components in the actuator assemblies.

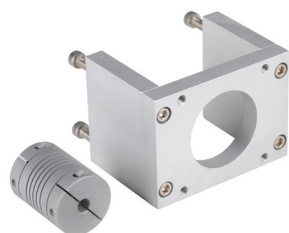

LARSACC-015(16)



LARSACC-013(014)

Some accessories not shown see www.AutomationDirect.com for additional product photos.



Linear Motion Products

Compact Slide Actuators - Generation 2

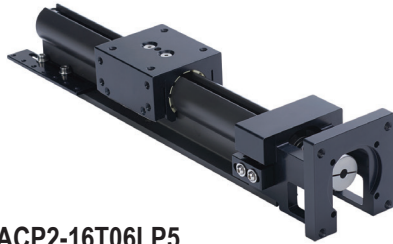

LACP2-16T06LP5

Description

Self-contained linear actuator designed for light loads in a very small package. The base is a single piece design with integrated slide surfaces, and is hard anodized all over.

Generation 2 actuators have a reduced part count for more reliable operation, integral wireway through the body and more robust motor mount that fits both NEMA 17 and 23 motors.

Features

- Compact design
- Replacement components available
- Ready for NEMA 17 motor (NEMA 23 motor requires new coupling)
- End-of-travel switch mounts
- AISI 6061-T6 Aluminum Alloy base, Hard Anodized on all surfaces to a depth of 0.0005 to 0.0015"
- AISI 303 Stainless Steel Lead Screw

Applications

- Space-limiting applications
- Light loads
- Speeds up to 20 inches per second

Compact Slide Actuator Specifications									
Part Number	Price	Drive Type	Drive Pitch	Drive Screw Efficiency (%)	Payload Inertia Factor (in ²)	Constant System Inertia (lbm-in ²)	Travel	Weight (lb)	Fits Motor
LACP2-16T06LP5	\$1,485.00	Lead screw	0.5 in	52	0.0063	0.016	6in	1.8	NEMA 17
LACP2-16T12LP5	\$1,566.00					0.017	12in	2.3	
LACP2-16T24LP5	\$2,065.00					0.020	24in	3.5	
LACP2-16T36LP5	\$2,460.00					0.024	36in	4.5	
LACP2-16T06L1	\$1,485.00					1in	44	0.025	
LACP2-16T12L1	\$1,566.00	0.023	12in	2.3					
LACP2-16T24L1	\$2,065.00	0.026	24in	3.5					
LACP2-16T36L1	\$2,460.00	0.030	36in	4.5					

System Inertia Calculation:

- To calculate the inertia reflected to the motor in a particular actuator, multiply the carriage payload by the payload inertia factor and then add the constant system inertia value for that actuator. The constant system inertia value for each system includes the inertia of the shaft coupler, carriage, and lead/ball screw.
- The payload must be in units of lb_m.

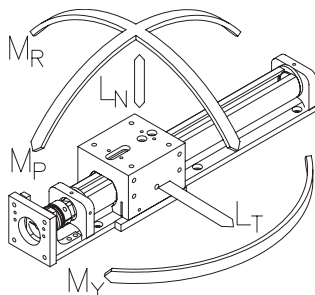

Load rating diagram

Compact Slide Actuator Load/Moment Ratings							
Part Number	Actuator Thrust	Load (lb)*			Moment (lb-in)**		
		Normal – LN		Transverse LT	Roll MR	Pitch MP	Yaw MY
		Down	Up				
LACP2-16TxxLP5	51	125	60	125	12	15	33
LACP2-16TxxL1	28	125	60	125	12	15	33

* 30lb is the recommended maximum load capacity if the carriage is not externally supported against rolling. The higher load capacities are possible if the carriage is externally supported.

** It is recommended that offset loads be located 5 inches or less from the center of the carriage. When the loads are offset at greater distances, the carriage can vibrate during travel.



Linear Motion Products

Compact Slide Actuators - Generation 2

Dimensions (in [mm])

PART NUMBER	A	B (TRAVEL)
LACP2-16T06LP5	11.57 [293.8]	6.40 [162.6]
LACP2-16T12LP5	17.57 [446.2]	12.40 [315.0]
LACP2-16T24LP5	29.57 [751.0]	24.40 [619.8]
LACP2-16T36LP5	41.57 [1055.8]	36.40 [924.6]
LACP2-16T06L1	11.57 [293.8]	6.40 [162.6]
LACP2-16T12L1	17.57 [446.2]	12.40 [315.0]
LACP2-16T24L1	29.57 [751.0]	24.40 [619.8]
LACP2-16T36L1	41.57 [1055.8]	36.40 [924.6]

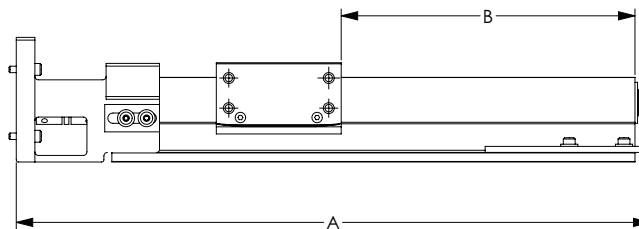
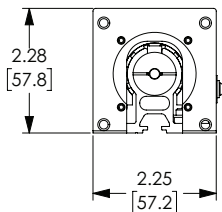
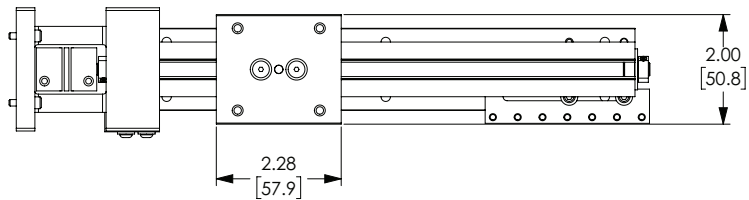

LACP2-16TxxLxx

See our website www.AutomationDirect.com for complete Engineering drawings.

Accessories

Compact Slide Actuator Accessories			
Part Number	Price	Description	Weight (lb)
LAVLACC-003*	\$316.00	SureMotion motor adapter, NEMA 23 frame. For use with LAVL2-60 series actuators. 1/4 inch x 5 mm coupler included.	1.0
LACPACC-0021	\$856.00	SureMotion repair kit, for use with LACP-16TxxLP5 actuators. Nut, bushings, end bearings and oil syringe included.	0.5
LACPACC-0031	\$856.00	SureMotion repair kit, for use with LACP-16TxxL1 actuators. Nut, bushings, end bearings and oil syringe included.	0.5
LACPACC-004	\$96.00	SureMotion mounting plate, XY type. For use with LACP2-16 series actuators.	0.5
LACPACC-005	\$122.00	SureMotion mounting plate, XY type. For use with LACP2-16 and LARSB1 series actuators.	0.5
LACPACC-0062	\$856.00	SureMotion repair kit, for use with LACP2-16TxxLP5 actuators. Nut, bushings, end bearings and oil syringe included.	1.0
LACPACC-0072	\$856.00	SureMotion repair kit, for use with LACP2-16TxxL1 actuators. Nut, bushings, end bearings and oil syringe included.	1.0

* Use the coupling and motor mount screws from this kit to adapt any LACP2 actuator assembly to accept a NEMA 23 motor.

1 These repair kits contain parts to rebuild Generation 1 (LACP series) actuator assemblies.

2 These repair kits contain parts to rebuild current Generation 2 (LACP2 series) actuator assemblies.



LAVLACC-003



LACPACC-002(003)



LACPACC-004(005)

Some accessories not shown see www.AutomationDirect.com for additional product photos.



Linear Motion Products

Value Linear Slide Actuators - Generation 2



LAVL2-60T06LP2

Features

- Maintenance-free Rails and Rail Bushings
- Small footprint
- Adjustable carriage pre-load
- Replacement components available
- Ready for NEMA 17 motor
- T-slots enable limit switches to be positioned anywhere
- AISI 6061-T6 Aluminum Alloy base, hard anodized on all surfaces to a depth of 0.0005 to 0.0015"
- AISI 304 Stainless Steel Lead Screw
- Acetal NTA3 Lead Nut
- Drylin® Rail Bushings

Description

Low-cost linear actuator using the latest in sliding element technology. The base is a single piece design with integrated slide surfaces, and is hard anodized all over. This versatile unit can be mounted horizontally, vertically, or inverted without loss of load capacity.

Generation 2 actuators have a reduced part count for more reliable operation, integral sensor mount grooves on both sides and a more robust motor mount.

Applications

- Harsh or wet environments
- X-Y-Z positioning systems

Value Linear Slide Actuator Specifications

Part Number	Price	Drive Type	Drive Pitch	Drive Screw Efficiency (%)	Payload Inertia Factor (in ²)	Constant System Inertia (lbm-in ²)	Travel	Weight (lb)	Fits Motor
LAVL2-60T06LP2	\$1,038.00	Lead screw	0.2 in	47	0.001	0.017	6in	2.0	NEMA 17
LAVL2-60T12LP2	\$1,304.00					0.020	12in	2.8	
LAVL2-60T18LP2	\$1,578.00					0.023	18in	3.5	
LAVL2-60T24LP2	\$1,842.00					0.027	24in	4.2	
LAVL2-60T06LP5	\$1,038.00		0.5 in	57	0.0063	0.019	6in	2.0	
LAVL2-60T12LP5	\$1,304.00					0.022	12in	2.8	
LAVL2-60T18LP5	\$1,578.00					0.025	18in	3.5	
LAVL2-60T24LP5	\$1,842.00					0.028	24in	4.2	

NOTE: The Lead Screw is lubricated at the factory with PTFE oil. It should be re-lubed periodically. Rails and bushing lubrication not required.

System Inertia Calculation:

- To calculate the inertia reflected to the motor in a particular actuator, multiply the carriage payload by the payload inertia factor and then add the constant system inertia value for that actuator. The constant system inertia value for each system includes the inertia of the shaft coupler, carriage, and lead/ball screw.
- The payload must be in units of lb_m.

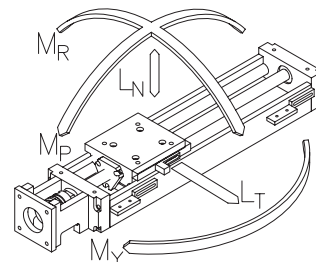

Load rating diagram

Value Linear Slide Actuator Load/Moment Ratings

Part Number	Actuator Thrust	Load (lb)			Moment (lb-in)*		
		Normal – LN		Transverse LT	Roll MR	Pitch MP	Yaw MY
		Down	Up				
LAVL2-60TxxLP2	70	110	110	110	50	32	32
LAVL2-60TxxLP5	50	110	110	110	50	32	32

* It is recommended that offset loads be located 5 inches or less from the center of the carriage. When the loads are offset at greater distances, the carriage can vibrate during travel.



Linear Motion Products

Value Linear Slide Actuators - Generation 2

Dimensions (in [mm])

PART NUMBER	A	B (TRAVEL)
LAVL2-60T06LP2	11.61 [294.8]	6.03 [153.1]
LAVL2-60T12LP2	17.61 [447.2]	12.03 [305.6]
LAVL2-60T18LP2	23.61 [599.6]	18.03 [458.0]
LAVL2-60T24LP2	29.61 [752.0]	24.03 [610.3]
LAVL2-60T06LP5	11.61 [294.8]	6.03 [153.1]
LAVL2-60T12LP5	17.61 [447.2]	12.03 [305.6]
LAVL2-60T18LP5	23.61 [599.6]	18.03 [458.0]
LAVL2-60T24LP5	29.61 [752.0]	24.03 [610.3]

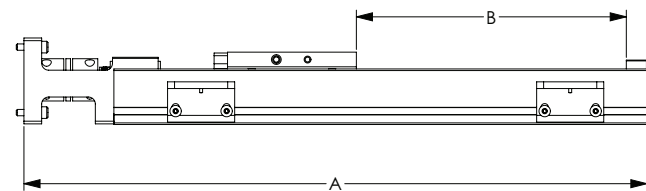
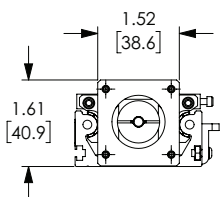
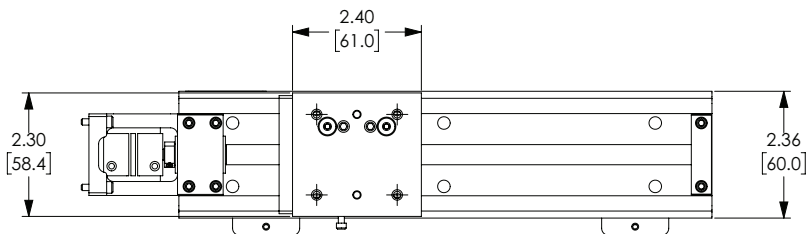

LAVL2-60TxxLPx

See our website www.AutomationDirect.com for complete Engineering drawings.

Accessories

Value Linear Slide Actuator Accessories			
Part Number	Price	Description	Weight (lb)
LAVLACC-001*	\$380.00	SureMotion repair kit, for use with LAVL-60TxxLP2 actuators. Nut, bushings, end bearings and oil syringe included.	0.5
LAVLACC-002*	\$380.00	SureMotion repair kit, for use with LAVL-60TxxLP5 actuators. Nut, bushings, end bearings and oil syringe included.	0.5
LAVLACC-003	\$316.00	SureMotion motor adapter, NEMA 23 frame. For use with LAVL2-60 series actuators. 1/4 inch x 5 mm coupler included.	1.0
LAVLACC-004	\$147.00	SureMotion mounting plate, XY type. For use with LAVL2-60 series actuators.	0.5
LAVLACC-005	\$331.00	SureMotion mounting plate, XZ type. For use with LAVL2-60 series actuators.	1.0
LAVLACC-006*	\$380.00	SureMotion repair kit, for use with LAVL2-60TxxLP2 actuators. Nut, bushings, end bearings and oil syringe included.	1.0
LAVLACC-007*	\$380.00	SureMotion repair kit, for use with LAVL2-60TxxLP5 actuators. Nut, bushings, end bearings and oil syringe included.	1.0

* Repair kits contain replacement components that are the same as the original components in the actuator assemblies.



Some accessories not shown see www.AutomationDirect.com for additional product photos.



Linear Motion Products

Round-Shaft Slide Elements

Description

Round-shaft sliding elements can be combined with other elements to build a huge variety of machine mechanisms. Available in both end- and continuously-supported shafts.

Features

- Linear ball bearings
- High quality clear anodized aluminum blocks
- AISI 1566 Carbon Steel, 60 RC Round Shafts



NOTE: Pillow blocks are shipped without lubrication and should be lubricated prior to use. A lubrication port is available.

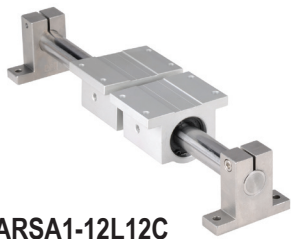

LARSACC-001/007



LARSACC-002/008

Slide Rail Systems Load Ratings

Part Number	Normal (lb)		Transverse (lb)
	Down	Up	
Pillow Blocks / Bushings for LARSA1			
LARSACC-001/007	230		
LARSACC-002/008	470		
LARSACC-003/009	850		
LARSA1 Linear Slide Assemblies			
LARSA1-08LxxC	460		
LARSA1-12LxxC	940		
LARSA1-16LxxC	1700		
Pillow Blocks / Bushings for LARSB1			
LARSACC-004/010	230	161	230
LARSACC-005/011	470	268	470
LARSACC-006/012	850	485	850
LARSB1 Linear Slide Assemblies			
LARSB1-08LxxC	460	322	460
LARSB1-12LxxC	940	536	940
LARSB1-16LxxC	1700	970	1700

End-Supported Slide Rail Systems				
Part Number	Price	Shaft Diameter	Overall Length (in)	Weight (lb)
LARSA1-08L12C	\$354.00	1/2	12	1.5
LARSA1-08L24C	\$366.00	1/2	24	2.0
LARSA1-08L36C	\$393.00	1/2	36	2.7
LARSA1-12L12C	\$447.00	3/4	12	3.0
LARSA1-12L24C	\$473.00	3/4	24	4.5
LARSA1-12L36C	\$498.00	3/4	36	6.0
LARSA1-16L12C	\$597.00	1	12	6.0
LARSA1-16L24C	\$637.00	1	24	8.5
LARSA1-16L36C	\$671.00	1	36	11.0

Closed Type Pillow Blocks and Bushings				
Part Number	Price	Fits Shaft Diameter (in)	Weight (lb)	Image
LARSACC-001	\$69.00	1/2	0.3	
LARSACC-002	\$89.00	3/4	0.6	
LARSACC-003	\$125.00	1	1.2	
LARSACC-007	\$27.00	1/2	0.1	
LARSACC-008	\$31.50	3/4	0.2	
LARSACC-009	\$51.00	1	0.3	

(2) single pillow blocks included
 * Bushings and pillow blocks are replacement components that are the same as the original components in the slide assemblies.

Continuously-Supported Slide Rail Systems				
Part Number	Price	Shaft Diameter	Overall Length (in)	Weight (lb)
LARSB1-08L12C	\$366.00	1/2	12	2.0
LARSB1-08L24C	\$456.00	1/2	24	3.0
LARSB1-08L36C	\$568.00	1/2	36	4.5
LARSB1-12L12C	\$458.00	3/4	12	4.0
LARSB1-12L24C	\$597.00	3/4	24	6.2
LARSB1-12L36C	\$733.00	3/4	36	9.0
LARSB1-16L12C	\$594.00	1	12	6.5
LARSB1-16L24C	\$768.00	1	24	10.5
LARSB1-16L36C	\$925.00	1	36	14.5

Open Type Pillow Blocks and Bushings				
Part Number	Price	Fits Shaft Diameter (in)	Weight (lb)	Image
LARSACC-004*	\$76.00	1/2	0.3	
LARSACC-005*	\$97.00	3/4	0.6	
LARSACC-006*	\$138.00	1	1.2	
LARSACC-010	\$31.50	1/2	0.1	
LARSACC-011	\$39.50	3/4	0.2	
LARSACC-012	\$65.00	1	0.3	

*Preload Adjustment available

(2) single pillow blocks included
 * Bushings and pillow blocks are replacement components that are the same as the original components in the slide assemblies.



Linear Motion Products

Round-Shaft Slide Elements

Dimensions (in [mm])

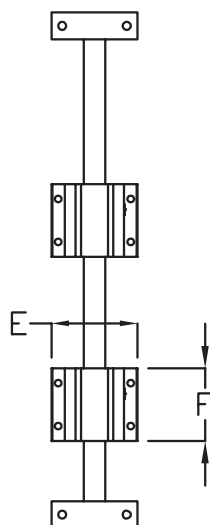
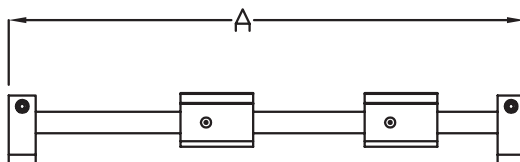
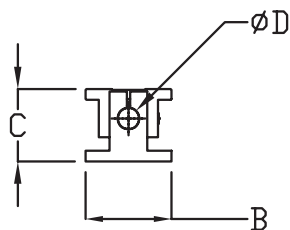

PART #	A	B	C	ØD	E	F
LARSA1-08L12C	12.0 [304.8]	2.00 [50.8]	1.70 [42.9]	0.50 [12.7]	2.00 [50.8]	1.69 [42.9]
LARSA1-08L24C	24.0 [609.6]					
LARSA1-08L36C	36.0 [914.4]					
LARSA1-12L12C	12.0 [304.8]	2.50 [63.5]	2.19 [55.6]	0.75 [19.0]	2.75 [69.9]	2.06 [52.4]
LARSA1-12L24C	24.0 [609.6]					
LARSA1-12L36C	36.0 [914.4]					
LARSA1-16L12C	12.0 [304.8]	3.06 [77.8]	2.69 [68.3]	1.00 [25.4]	3.25 [82.6]	2.81 [71.5]
LARSA1-16L24C	24.0 [609.6]					
LARSA1-16L36C	36.0 [914.4]					
LARSB1-08L12C	12.0 [304.8]	1.50 [38.1]	1.81 [46.0]	0.50 [12.7]	2.00 [50.8]	1.50 [38.1]
LARSB1-08L24C	24.0 [609.6]					
LARSB1-08L36C	36.0 [914.4]					
LARSB1-12L12C	12.0 [304.8]	1.75 [44.5]	2.44 [61.9]	0.75 [19.0]	2.75 [69.9]	1.88 [47.6]
LARSB1-12L24C	24.0 [609.6]					
LARSB1-12L36C	36.0 [914.4]					
LARSB1-16L12C	12.0 [304.8]	2.13 [54.0]	2.94 [74.6]	1.00 [25.4]	3.25 [82.6]	2.63 [66.7]
LARSB1-16L24C	24.0 [609.6]					
LARSB1-16L36C	36.0 [914.4]					

LARSA1-xxLxxC
& LARSB1-xxLxxC*

*LARSA1-xxLxxC is shown in drawing. LARSB1-xxLxxC has different appearance, but same dimensions as shown in this table.

See our website www.AutomationDirect.com for complete Engineering drawings.