



# Linear Motion Products

## Value Linear Slide Actuators - Generation 2



### Description

Low-cost linear actuator using the latest in sliding element technology. The base is a single piece design with integrated slide surfaces, and is hard anodized all over. This versatile unit can be mounted horizontally, vertically, or inverted without loss of load capacity.

Generation 2 actuators have a reduced part count for more reliable operation, integral sensor mount grooves on both sides and a more robust motor mount.

### LAVL2-60T06LP2

#### Features

- Maintenance-free Rails and Rail Bushings
- Small footprint
- Adjustable carriage pre-load
- Replacement components available
- Ready for NEMA 17 motor
- T-slots enable limit switches to be positioned anywhere
- AISI 6061-T6 Aluminum Alloy base, hard anodized on all surfaces to a depth of 0.0005 to 0.0015"
- AISI 304 Stainless Steel Lead Screw
- Acetal NTA3 Lead Nut
- Drylin® Rail Bushings

#### Applications

- Harsh or wet environments
- X-Y-Z positioning systems

Value Linear Slide Actuator Specifications									
Part Number	Price	Drive Type	Drive Pitch	Drive Screw Efficiency (%)	Payload Inertia Factor (in <sup>2</sup> )	Constant System Inertia (lbm-in <sup>2</sup> )	Travel	Weight (lb)	Fits Motor
<a href="#">LAVL2-60T06LP2</a>	\$1,038.00	Lead screw	0.2 in	47	0.001	0.017	6in	2.0	NEMA 17
<a href="#">LAVL2-60T12LP2</a>	\$1,304.00					0.020	12in	2.8	
<a href="#">LAVL2-60T18LP2</a>	\$1,578.00					0.023	18in	3.5	
<a href="#">LAVL2-60T24LP2</a>	\$1,842.00					0.027	24in	4.2	
<a href="#">LAVL2-60T06LP5</a>	\$1,038.00		0.5 in	57	0.0063	0.019	6in	2.0	
<a href="#">LAVL2-60T12LP5</a>	\$1,304.00					0.022	12in	2.8	
<a href="#">LAVL2-60T18LP5</a>	\$1,578.00					0.025	18in	3.5	
<a href="#">LAVL2-60T24LP5</a>	\$1,842.00					0.028	24in	4.2	

NOTE: The Lead Screw is lubricated at the factory with PTFE oil. It should be re-lubed periodically. Rails and bushing lubrication not required.

#### System Inertia Calculation:

- To calculate the inertia reflected to the motor in a particular actuator, multiply the carriage payload by the payload inertia factor and then add the constant system inertia value for that actuator. The constant system inertia value for each system includes the inertia of the shaft coupler, carriage, and lead/ball screw.
- The payload must be in units of lb<sub>m</sub>.

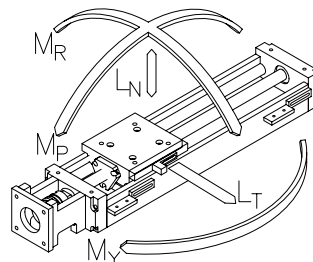

Load rating diagram

Value Linear Slide Actuator Load/Moment Ratings							
Part Number	Actuator Thrust	Load (lb)			Moment (lb-in)*		
		Normal – LN		Transverse LT	Roll MR	Pitch MP	Yaw MY
		Down	Up				
LAVL2-60TxxLP2	70	110	110	110	50	32	32
LAVL2-60TxxLP5	50	110	110	110	50	32	32

\* It is recommended that offset loads be located 5 inches or less from the center of the carriage. When the loads are offset at greater distances, the carriage can vibrate during travel.



# Linear Motion Products

## Value Linear Slide Actuators - Generation 2

Dimensions (in [mm])

PART NUMBER	A	B (TRAVEL)
LAVL2-60T06LP2	11.61 [294.8]	6.03 [153.1]
LAVL2-60T12LP2	17.61 [447.2]	12.03 [305.6]
LAVL2-60T18LP2	23.61 [599.6]	18.03 [458.0]
LAVL2-60T24LP2	29.61 [752.0]	24.03 [610.3]
LAVL2-60T06LP5	11.61 [294.8]	6.03 [153.1]
LAVL2-60T12LP5	17.61 [447.2]	12.03 [305.6]
LAVL2-60T18LP5	23.61 [599.6]	18.03 [458.0]
LAVL2-60T24LP5	29.61 [752.0]	24.03 [610.3]

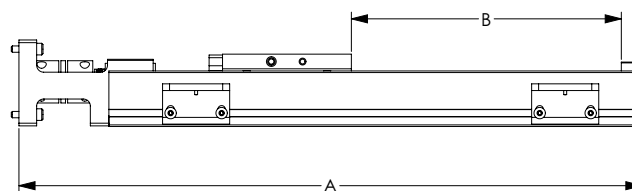
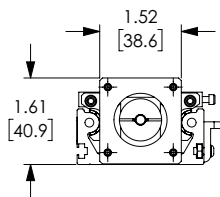
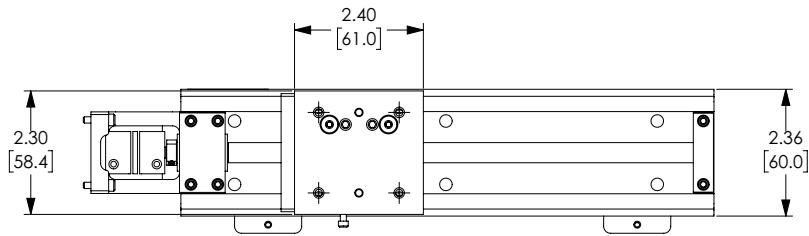

LAVL2-60TxxLPx

See our website [www.AutomationDirect.com](http://www.AutomationDirect.com) for complete Engineering drawings.

### Accessories

Value Linear Slide Actuator Accessories			
Part Number	Price	Description	Weight (lb)
<a href="#">LAVLACC-001*</a>	\$380.00	SureMotion repair kit, for use with LAVL-60TxxLP2 actuators. Nut, bushings, end bearings and oil syringe included.	0.5
<a href="#">LAVLACC-002*</a>	\$380.00	SureMotion repair kit, for use with LAVL-60TxxLP5 actuators. Nut, bushings, end bearings and oil syringe included.	0.5
<a href="#">LAVLACC-003</a>	\$316.00	SureMotion motor adapter, NEMA 23 frame. For use with LAVL2-60 series actuators. 1/4 inch x 5 mm coupler included.	1.0
<a href="#">LAVLACC-004</a>	\$147.00	SureMotion mounting plate, XY type. For use with LAVL2-60 series actuators.	0.5
<a href="#">LAVLACC-005</a>	\$331.00	SureMotion mounting plate, XZ type. For use with LAVL2-60 series actuators.	1.0
<a href="#">LAVLACC-006*</a>	\$380.00	SureMotion repair kit, for use with LAVL2-60TxxLP2 actuators. Nut, bushings, end bearings and oil syringe included.	1.0
<a href="#">LAVLACC-007*</a>	\$380.00	SureMotion repair kit, for use with LAVL2-60TxxLP5 actuators. Nut, bushings, end bearings and oil syringe included.	1.0

\* Repair kits contain replacement components that are the same as the original components in the actuator assemblies.



Some accessories not shown see [www.AutomationDirect.com](http://www.AutomationDirect.com) for additional product photos.

# Linear Motion Slides and Components to Create up to 3 Axes of Motion

SureMotion linear slide actuators easily mate to SureStep motors, SureServo motors and other NEMA motors. Everything you need to mount your SureStep motor is included!

SureMotion linear actuators provide high performance linear motion. Available in lead screw or ball screw controlled versions. Coupling and hardware to mount small NEMA frame and SureServo motors are available as well as hardware to attach units together to create motion in 2 or 3 axes of movement.

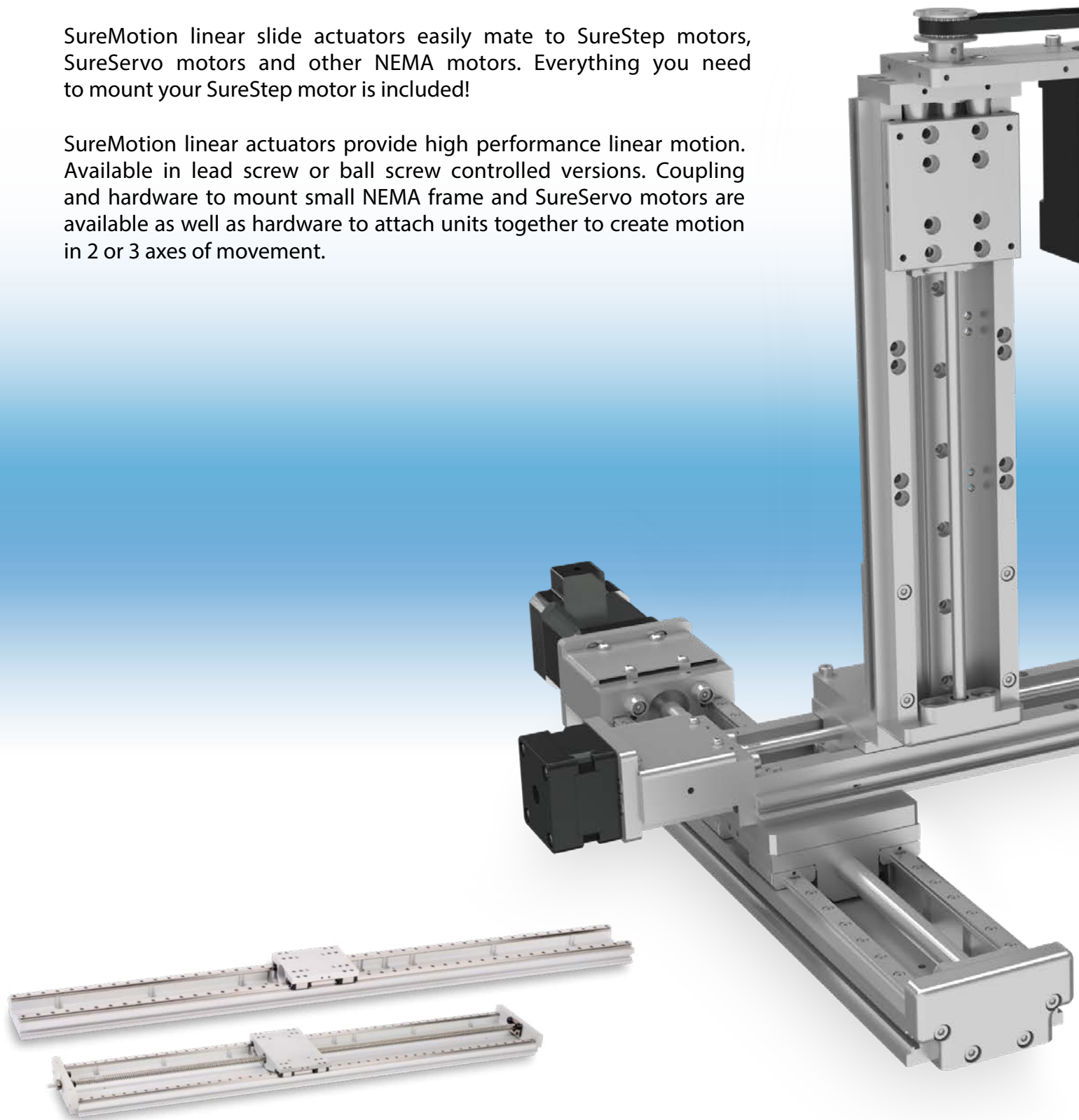

# Sure motion

**LAHP units can be attached to each other to provide up to 3 axes of motion and from 52mm to 910mm of travel.**

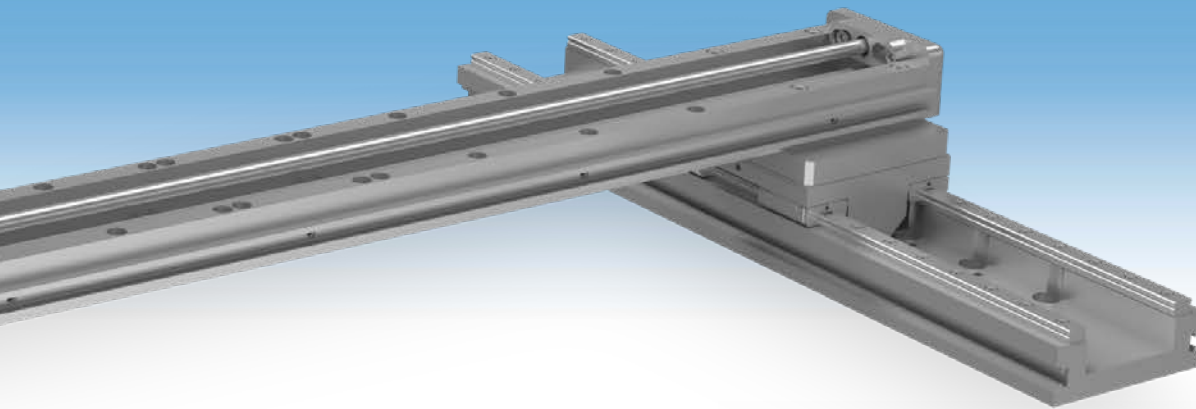

**18 models, with travels from 6 to 36 inches**

**Ready to mount NEMA 17, 23 or 34 motors**





# Linear Motion Products

## Product Overview

### Actuator Overview

SureMotion linear motion offers both motor-ready actuator assemblies, and a versatile assortment of sliding components and accessories to provide a wide variety of motion control solutions.

#### Linear Slide Actuator Comparisons

Actuator Series Comparisons						
Actuator Series	Actuator Type	Drive Type	Max Load Capacity (lb)	Max Speed (in/s)	Travel (in)	Relative Price
LARSD2	Twin Round Shaft	Ball Screw	920	6	12, 24	\$\$\$\$
LACP2	Compact Slide	Lead Screw	125	20	6, 12, 24, 36	\$\$
LAVL2	Value Slide	Lead Screw	110	15	6, 12, 18, 24	\$



#### Available Multi-Axis Configurations

##### X-Y Axis Configurations

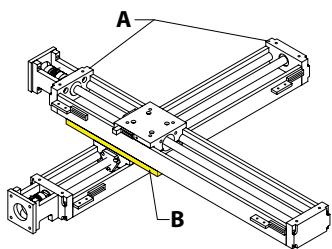

A. (2) LAVL2-60Txxxx  
B. (1) LAVLACC-004

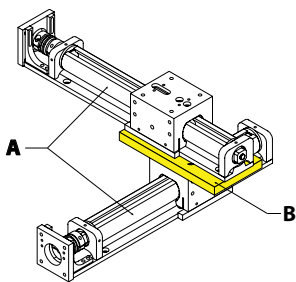

A. (2) LACP2-16Txxxx  
B. (1) LACPACC-004

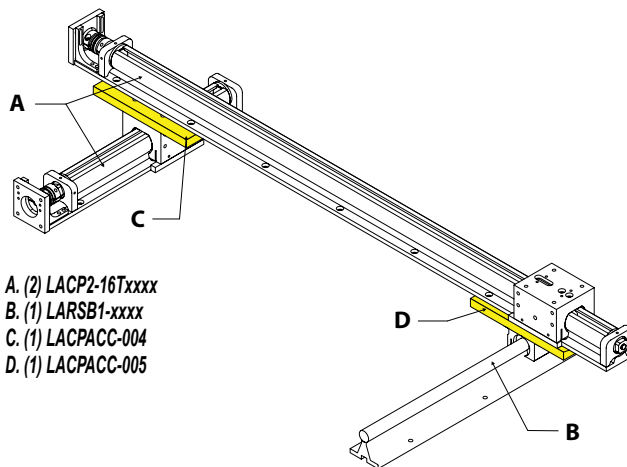

A. (2) LACP2-16Txxxx  
B. (1) LARSB1-xxxx  
C. (1) LACPACC-004  
D. (1) LACPACC-005

##### X-Z Axis Configuration

##### X-Y-Z Axis Configuration

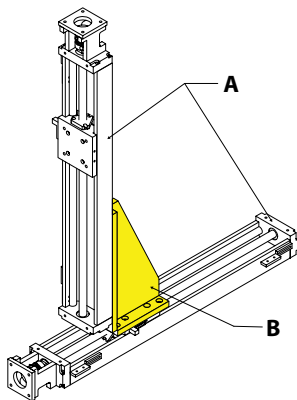

A. (2) LAVL2-60Txxxx  
B. (1) LAVLACC-005

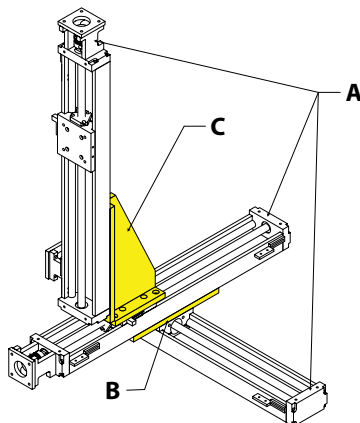

A. (3) LAVL2-60Txxxx  
B. (1) LAVLACC-004  
C. (1) LAVLACC-005



Click on the above video link for a short visual example of how our products can be used.