

# SureFrame<sup>®</sup> Aluminum T-Slotted Rail

## 10 Series Fractional T-Slotted Aluminum Rail

SureFrame™ T-slotted aluminum rails are extruded exclusively for AutomationDirect, with features, quality, and performance you expect. SureFrame T-slotted rails are compatible with other popular brands.

- Cut to length in 0.001 inch increments
- Minimum cut length: 6"
- Maximum cut length: 90"
- Cut accuracy: +/- 0.006"
- Corrosion and UV resistant



Properties	
<b>Material</b>	Aluminum 6063-T6
<b>Finish</b>	Clear or Black Anodize
<b>Hardness</b>	Webster Model B 11-12
<b>Straightness</b>	0.0125 inch/ft [1.042 mm/m]
<b>Twist</b>	0.25°/ft [0.25°/305mm]

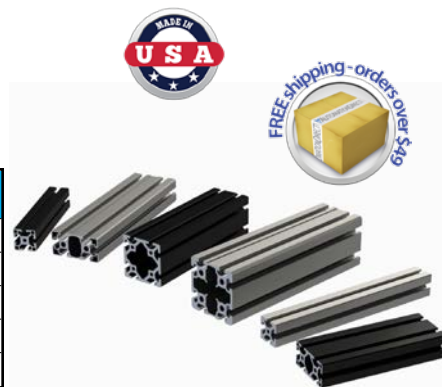

10 Series (inch)								
Slot Size 6 Core Hole Ø 0.20"					Drop Lock T-Slot Drop Lock feature improves connection strength and vibration resistance			
Part Number	Part Image	Price per inch	Profile Size	Weight Class	Weight lbs/ft [kg/m]	Moment of Inertia Lx	Moment of Inertia Ly	Drawing Link
<a href="#"><u>1010C</u></a>		\$0.24	1 x 1in	Standard	0.529 [0.787]	0.045 in <sup>4</sup> [1.872 cm <sup>4</sup> ]	0.045 in <sup>4</sup> [1.872 cm <sup>4</sup> ]	<a href="#"><u>PDF</u></a>
<a href="#"><u>1010B</u></a>		\$0.49						<a href="#"><u>PDF</u></a>
<a href="#"><u>1020C</u></a>		\$0.41	1 x 2in		0.952 [1.417]	0.084 in <sup>4</sup> [3.494 cm <sup>4</sup> ]	0.308 in <sup>4</sup> [12.813 cm <sup>4</sup> ]	<a href="#"><u>PDF</u></a>
<a href="#"><u>1020B</u></a>		\$0.75						<a href="#"><u>PDF</u></a>
<a href="#"><u>2020C</u></a>		\$0.61	2 x 2in		1.482 [2.205]	0.543 in <sup>4</sup> [22.589 cm <sup>4</sup> ]	0.543 in <sup>4</sup> [22.589 cm <sup>4</sup> ]	<a href="#"><u>PDF</u></a>
<a href="#"><u>2020B</u></a>		\$0.99						<a href="#"><u>PDF</u></a>

Extruded T-slotted rails have a thru Core Hole feature that can be used to attach various components to the end of the profile using:

- Self-tapping / thread-forming screws (no tapping needed)
- A tap to thread the core hole for a threaded fastener

*Please Note: Prices on aluminum are closely tied to the market price. This allows us to offer the best savings possible if conditions are favorable; however, it also means that our prices may increase if market conditions warrant.*





# Aluminum T-Slotted Rail

## Deflection Calculations

Using the calculations below, find your approximate deflection\* for a specific extrusion. See table below for variations.

**As always when calculating, use diligence and work only in either imperial or metric units at one time.**

- "E" = Modulus of Elasticity
- "F" = Force
- "I" = Moment of Inertia
- "L" = Length
- "W" = Weight

Aluminum 6063-T6 Properties	
Yield Strength	29,007 psi [200 MPa]
Tensile Strength	33,359 psi [230 MPa]
Modulus of Elasticity	10,000,000 psi [68.9 GPa]

*\*for reference only*

### Supported Loads

CONCENTRATED LOAD AT CENTER (simply supported)

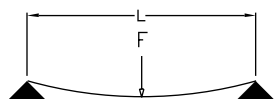

$$\text{MAX DEFLECTION} = \frac{FL^3}{48 EI}$$

UNIFORMLY DISTRIBUTED LOAD (simply supported)

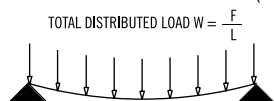

$$\text{MAX DEFLECTION} = \frac{5}{84} \frac{WL^4}{EI}$$

CONCENTRATED LOAD AT CENTER (between fixed supports)

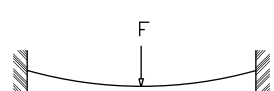

$$\text{MAX DEFLECTION} = \frac{FL^3}{192 EI}$$

UNIFORMLY DISTRIBUTED LOAD (between fixed supports)

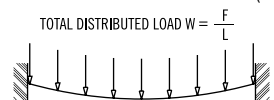

$$\text{MAX DEFLECTION} = \frac{WL^4}{384 EI}$$

### Cantilever Loads

CONCENTRATED LOAD AT CENTER (simply supported)

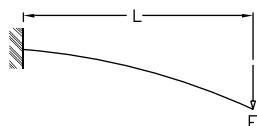

$$\text{MAX DEFLECTION} = \frac{FL^3}{3 EI}$$

UNIFORMLY DISTRIBUTED LOAD (simply supported)

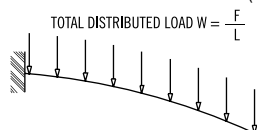

$$\text{MAX DEFLECTION} = \frac{WL^4}{8 EI}$$

# FATH® T-Slotted Rail Accessories

## T-Slot Nuts

- Designed to fit into the T-slot cavity of extruded aluminum rails.
- Hammer nuts provide safe electrostatic discharging (ESD) connection.
- No machining required.
- Material: zinc plated steel



T-Slot Nuts Selection				
Part Image	Nut Type	Installation	Holds Position Without Screw	ESD Connection
	Double Economy T-Nut		No	No
	Economy T-Nut			
	Hammer Nut		No	Yes
	Slide-In Nut		Yes	No
	Roll-In Nut with Leaf Spring			
	Roll-In Nut with Spring Loaded Ball			

## 10 Series T-Slot Nuts

Fits Slot Size

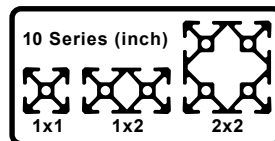

Part Number	Part Image	Price	Nut Type	Thread Size	Pack Quantity	Drawing Link
<a href="#">161113</a>		\$13.00	Roll-In Nut	8-32 UNF	10	<a href="#">PDF</a>
<a href="#">161124</a>		\$9.50	Hammer Nut			<a href="#">PDF</a>
<a href="#">161112</a>		\$13.00	Roll-In Nut	10-32 UNF		<a href="#">PDF</a>
<a href="#">151038</a>		\$11.00	Hammer Nut	10-32 UNF		<a href="#">PDF</a>
<a href="#">148804</a>		\$4.00	Double Economy T-Nut	1/4-20 UNC	4	<a href="#">PDF</a>
<a href="#">151037</a>		\$5.50	Economy T-Nut		10	<a href="#">PDF</a>
<a href="#">151039</a>		\$15.00	Roll-In Nut		<a href="#">PDF</a>	

# FATH® T-Slotted Rail Accessories

## Fasteners



- Choose from 4 Head types in numerous lengths
- Hex socket head
- Select desired T-Slot nut style with corresponding thread size.
- Material: Black zinc plated or bright zinc plated steel, prevents corrosion better than typical black oxide coatings



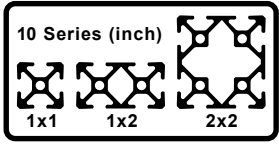

10 Series Fasteners									
		Fits  Slot Size 6							
Part Number	Part Image	Price	Thread	Screw Length	Head Type	Color	Pack Quantity	Drawing Link	
<a href="#">162994</a>		\$8.00	#8-32 UNF	3/8 in	Button head socket cap screw	Flat black	10	<a href="#">PDF</a>	
<a href="#">161073</a>		\$7.75		1/2 in	Flat head socket cap screw			<a href="#">PDF</a>	
<a href="#">162993</a>		\$7.50	#10-32 UNF	3/8 in	Button head socket cap screw			<a href="#">PDF</a>	
<a href="#">162995</a>		\$7.75		1/2 in	Socket head cap screw			<a href="#">PDF</a>	
<a href="#">161046</a>		\$4.75			5/8 in			Button head socket cap screw	<a href="#">PDF</a>
<a href="#">161047</a>		\$5.00		3/4 in	<a href="#">PDF</a>				
<a href="#">161048</a>		\$5.75		1/4-20 UNC	1/2 in			Flat head socket cap screw	<a href="#">PDF</a>
<a href="#">151040</a>		\$4.25						Button head socket cap screw	<a href="#">PDF</a>
<a href="#">151041</a>		\$5.25	9/16 in		Flanged button head socket cap screw			Gloss black	<a href="#">PDF</a>
<a href="#">161049</a>		\$4.50	5/8 in		Flat head socket cap screw			Flat black	<a href="#">PDF</a>
<a href="#">161075</a>		\$6.25		Button head socket cap screw	<a href="#">PDF</a>				
<a href="#">161050</a>		\$4.75		Socket head cap screw	<a href="#">PDF</a>				
<a href="#">161087</a>		\$4.00				<a href="#">PDF</a>			

# FATH® T-Slotted Rail Accessories

## Fasteners - Continued

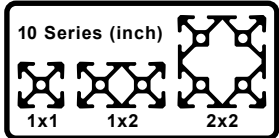
10 Series Fasteners								
		Fits 						
Part Number	Part Image	Price	Thread	Screw Length	Head Type	Color	Pack Quantity	Drawing Link
<a href="#">161051</a>		\$4.75	1/4-20 UNC	3/4 in	Button head socket cap screw	Flat black	10	<a href="#">PDF</a>
<a href="#">161052</a>		\$5.25	1/4-20 UNC	1 in				<a href="#">PDF</a>

10 Series Self Forming / Tapping Screw								
		Fits 					Works with Aluminum with hole diameter 0.197" - 0.216" [5.0 - 5.5 mm]	
Part Number	Part Image	Price	Thread	Screw Length	Head Type	Color	Pack Quantity	Drawing Link
<a href="#">161103</a>		\$8.75	S6	16mm	Self-Tapping Screw Button head socket cap T-25 Torx	Bright zinc	10	<a href="#">PDF</a>

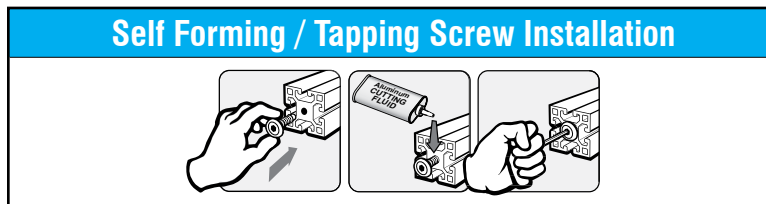

# FATH® T-Slotted Rail Accessories

## Connecting Components





- Connects two or three T-slot rails together
- Recommended ADC Fastener based on part feature, slot depth and core hole
- Material: varies by part

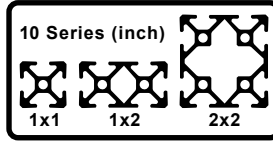

### 10 Series Connecting Components

Fits  Slot Size 6



Part Number	Part Image	Price	Description	Fits Profile	Material	Recommended Screw Fastener (ADC Part Number)		Pack Quantity	Drawing Link
						Core Hole Attachment <b>1</b>	*T-Slot Attachment <b>2</b>		
<a href="#">148953</a>		\$8.25	2d Cube Connector	1 x 1in	Die-cast aluminum	<a href="#">161103</a>	Socket Head Cap Screw 1/4-20 x 7/16" **	1	<a href="#">PDF</a>
<a href="#">166230</a>		\$10.00							<a href="#">PDF</a>
<a href="#">148956</a>		\$10.50	3d Cube Connector	1 x 1in	Die-cast aluminum	<a href="#">161103</a>	n/a	1	<a href="#">PDF</a>
<a href="#">166231</a>		\$12.00							<a href="#">PDF</a>
<a href="#">151042</a>		\$4.25	Angle Connector	1 x 1in	Die-cast aluminum	<a href="#">161103</a>	151040	1	<a href="#">PDF</a>
<a href="#">166232</a>		\$4.75							<a href="#">PDF</a>
<a href="#">151043</a>		\$7.50		1 x 2in					<a href="#">PDF</a>
<a href="#">166233</a>		\$8.00							<a href="#">PDF</a>
<a href="#">163007</a>		\$10.50	Screw Connector	1 x 1in	Zinc plated steel	Designer's choice	n/a	10	<a href="#">PDF</a>

\*T-Slot Nut also required.

\*\* Recommended fastener not available from AutomationDirect.com

# FATH® T-Slotted Rail Accessories

## Connecting Components - Continued

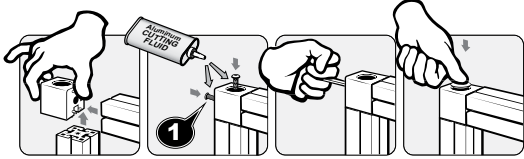
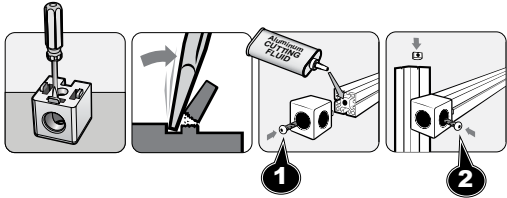
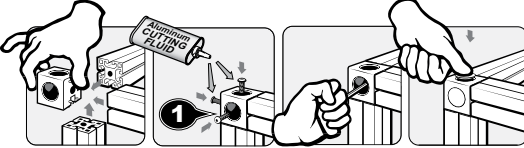
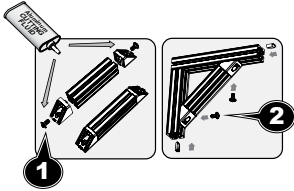
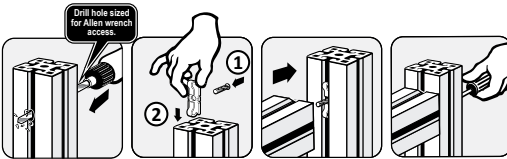









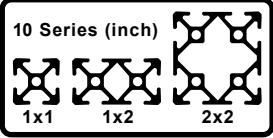



Connecting Components Installation	
Core Hole Installation	T-Slot Installation
<b>2D Cube Connector</b>	
	
<b>3D Cube Connector</b>	
	n/a
<b>Angle Connector</b>	
	
<b>Screw Connector</b>	
	

# FATH® T-Slotted Rail Accessories

## Joining Plates

- Connects two or more T-slot rails together
- Recommended ADC Fastener based on plate thickness and slot depth
- Material: Anodized aluminum



10 Series Joining Plates						
Fits 						
Part Number	Part Image	Price	Description	Recommended Screw Fastener *T-Slot Attachment (ADC Part Number)	Pack Quantity	Drawing Link
<a href="#">151044</a>		\$2.50	Straight Flat Plate	<a href="#">151040</a> or <a href="#">151041</a>	1	<a href="#">PDF</a>
<a href="#">166234</a>		\$3.00				<a href="#">PDF</a>
<a href="#">151045</a>		\$3.75				<a href="#">PDF</a>
<a href="#">166235</a>		\$4.00				<a href="#">PDF</a>
<a href="#">151046</a>		\$4.50				<a href="#">PDF</a>
<a href="#">166236</a>		\$5.00				<a href="#">PDF</a>
<a href="#">151047</a>		\$4.25				<a href="#">PDF</a>
<a href="#">166237</a>		\$5.00				<a href="#">PDF</a>
<a href="#">151048</a>		\$6.50	Rectangular Flat Plate	<a href="#">151040</a> or <a href="#">151041</a>	1	<a href="#">PDF</a>
<a href="#">166238</a>		\$7.00				<a href="#">PDF</a>
<a href="#">151049</a>		\$5.50				<a href="#">PDF</a>
<a href="#">166239</a>		\$6.00				<a href="#">PDF</a>
<a href="#">151050</a>		\$6.25	Flat Plate	<a href="#">151040</a> or <a href="#">151041</a>	1	<a href="#">PDF</a>
<a href="#">166240</a>		\$7.00				<a href="#">PDF</a>

\*T-Slot Nut also required



# FATH® T-Slotted Rail Accessories

## Joining Plates - Continued

10 Series Joining Plates - Cont'd						
						
Part Number	Part Image	Price	Description	Recommended Screw Fastener *T-Slot Attachment (ADC Part Number)	Pack Quantity	Drawing Link
<a href="#">151051</a>		\$6.50	Flat Plate	151040 or 151041	1	<a href="#">PDF</a>
<a href="#">166241</a>		\$7.00				<a href="#">PDF</a>
<a href="#">151052</a>		\$6.50	T-Shaped Flat Plate			<a href="#">PDF</a>
<a href="#">166242</a>		\$7.00				<a href="#">PDF</a>
<a href="#">151053</a>		\$7.25				<a href="#">PDF</a>
<a href="#">166243</a>		\$8.00				<a href="#">PDF</a>
<a href="#">151054</a>		\$10.50				<a href="#">PDF</a>
<a href="#">166244</a>		\$12.00				<a href="#">PDF</a>
<a href="#">151055</a>		\$9.50	Cross Flat Plate			<a href="#">PDF</a>
<a href="#">166245</a>		\$11.00				<a href="#">PDF</a>
<a href="#">151056</a>		\$8.00	L-Shaped Flat Plate			<a href="#">PDF</a>
<a href="#">166246</a>		\$9.00				<a href="#">PDF</a>
<a href="#">151057</a>		\$10.50	T-Shaped Flat Plate			<a href="#">PDF</a>
<a href="#">166247</a>		\$12.00				<a href="#">PDF</a>

\*T-Slot Nut also required

# FATH® T-Slotted Rail Accessories

## Brackets

- Connects two T-slot rails together at a 90° angle
- Recommended ADC Fastener based on part features and slot depth
- Material: varies by part



### 10 Series Brackets

Fits Slot Size 6

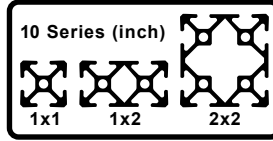











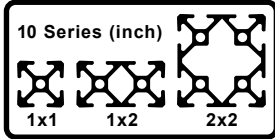

Part Number	Part Image	Price	Description	Recommended Screw Fastener (ADC Part Number)		Pack Quantity	Material	Drawing Link										
				Core Hole Attachment ①	*T-Slot Attachment ②													
<a href="#">148915</a>		\$1.50	Angle Bracket	n/a	<a href="#">162994</a>	1	Die-cast aluminum	<a href="#">PDF</a>										
<a href="#">166249</a>		\$1.50						<a href="#">PDF</a>										
<a href="#">151059</a>		\$4.00			<a href="#">162993</a>		Die-cast zinc	<a href="#">PDF</a>										
<a href="#">166250</a>		\$4.00						<a href="#">PDF</a>										
<a href="#">151058</a>		\$2.50	Inside Corner Bracket		n/a		1	Anodized aluminum	<a href="#">PDF</a>									
<a href="#">166248</a>		\$3.00							<a href="#">PDF</a>									
<a href="#">151061</a>		\$4.75	Tall Inside Corner Bracket						n/a	1	Anodized aluminum	<a href="#">PDF</a>						
<a href="#">166252</a>		\$5.00										<a href="#">PDF</a>						
<a href="#">151060</a>		\$4.75	Wide Inside Corner Bracket									n/a	1	Anodized aluminum	<a href="#">PDF</a>			
<a href="#">166251</a>		\$5.00													<a href="#">PDF</a>			
<a href="#">151062</a>		\$6.75	Inside Corner Bracket												n/a	1	Anodized aluminum	<a href="#">PDF</a>
<a href="#">166253</a>		\$8.00																<a href="#">PDF</a>

\*T-Slot Nut also required.

\*\* Recommended fastener not available from AutomationDirect.com

# FATH® T-Slotted Rail Accessories

## Brackets - Continued

10 Series Brackets - Cont'd												
		Fits  Slot Size 6										
Part Number	Part Image	Price	Description	Recommended Screw Fastener (ADC Part Number)		Pack Quantity	Material	Drawing Link				
				Core Hole Attachment <b>1</b>	*T-Slot Attachment <b>2</b>							
<a href="#">151063</a>		\$3.00	Gusseted Inside Corner Bracket	n/a	<a href="#">151040</a>	1	Anodized aluminum	<a href="#">PDF</a>				
<a href="#">166254</a>		\$3.00						<a href="#">PDF</a>				
<a href="#">151064</a>		\$5.25	Tall Gusseted Inside Corner Bracket					<a href="#">PDF</a>				
<a href="#">166255</a>		\$6.00						<a href="#">PDF</a>				
<a href="#">151065</a>		\$5.75	Wide Gusseted Inside Corner Bracket					<a href="#">PDF</a>				
<a href="#">166256</a>		\$6.00						<a href="#">PDF</a>				
<a href="#">151066</a>		\$10.50	Gusseted Inside Corner Bracket					<a href="#">PDF</a>				
<a href="#">166257</a>		\$12.00						<a href="#">PDF</a>				
<a href="#">151067</a>		\$30.50	Pivot Joint					<a href="#">161103</a>	<a href="#">161049</a>	1	Die-cast zinc	<a href="#">PDF</a>
<a href="#">166258</a>		\$36.00										<a href="#">PDF</a>
<a href="#">148932</a>		\$39.50	Pivot Joint With Locking Handle	<a href="#">PDF</a>								
<a href="#">166259</a>		\$47.00		<a href="#">PDF</a>								

\*T-Slot Nut also required.

\*\* Recommended fastener not available from AutomationDirect.com

# FATH<sup>®</sup> T-Slotted Rail Accessories

## Brackets - Continued

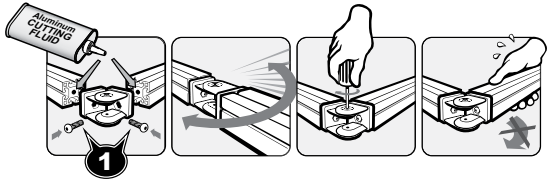
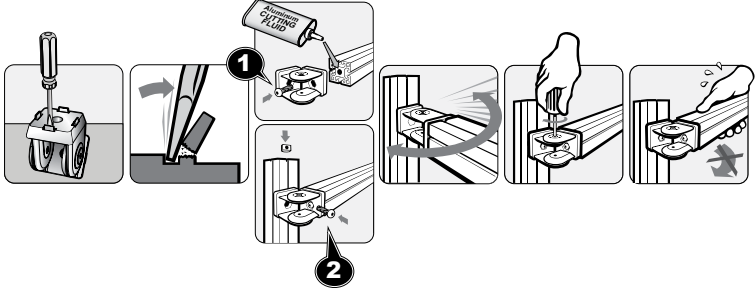







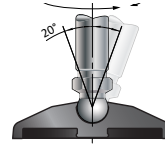

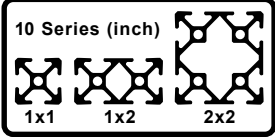

Brackets Installation	
Core Hole Installation	T-Slot Installation
<b>Pivot Joint</b>	
	

# FATH® T-Slotted Rail Accessories

## Bases

- Recommended ADC Fastener based on part features and extrusion core hole
- Material: varies by part



10 Series Bases											
		Fits 									
Part Number	Part Image	Price	Diameter	Description	Fits	Load Rating kg [lb]	Recommended Screw Fastener (ADC Part Number)		Pack Quantity	Material	Drawing Link
							Core Hole Attachment <b>1</b>	T-Slot Attachment <b>2</b>			
<a href="#">118356</a>		\$16.00	n/a	1/4-20 UNC Transport/Base Plate	1 x 2in	n/a	161103 (2) included with kit	n/a	1	Die-cast zinc	<a href="#">PDF</a>
<a href="#">146399</a>		\$16.00		3/8-16 UNC Transport/Base Plate							<a href="#">PDF</a>
<a href="#">151074</a>		\$7.25		1/4-20 UNC x 1-1/2in Swivel Foot Threaded Rod with 15 mm ball	Transport/Base Plate <a href="#">118356</a>	210 [463]*				Zinc plated steel	<a href="#">PDF</a>
<a href="#">151075</a>		\$4.50		3/8-16 UNC x 1-1/2in Swivel Foot Threaded Rod with 15 mm ball	Transport/Base Plate <a href="#">146399</a>	470 [1036]*				Zinc plated steel	<a href="#">PDF</a>
<a href="#">151068</a>		\$4.00	1.57 in [39.0 mm]	Swivel Base With Anti-Slip Plate	Any 15mm ball Threaded Rod	900 [1984]	n/a	1	Nylon	<a href="#">PDF</a>	
<a href="#">151071</a>		\$9.50				3000 [6614]				Die-cast zinc	<a href="#">PDF</a>
<a href="#">151072</a>		\$17.00	3.11 in [79.0 mm]			<a href="#">PDF</a>					
<a href="#">151073</a>		\$17.00				<a href="#">PDF</a>					
<a href="#">151069</a>		\$6.00				900 [1984]			Nylon	<a href="#">PDF</a>	
<a href="#">151070</a>		\$6.00				<a href="#">PDF</a>					
<a href="#">151255</a>		\$10.00	3.90 in [99.0 mm]			900 [1984]			<a href="#">PDF</a>		
<a href="#">151256</a>		\$10.00				<a href="#">PDF</a>					





\*Based on installation with Transport / Base Plate  
 Load rating of a swivel foot assembly is based on the part with the lowest load rating, typically the threaded rod.  
 Example:  
 Threaded rod load rating = 210kg [463lb]  
 Swivel base load rating = 3000kg [6614lb]  
 Swivel foot assembly load rating = 210kg [463lb]

# FATH® T-Slotted Rail Accessories

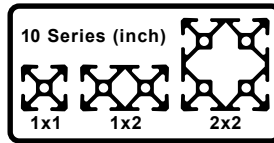
## Bases - Continued

### 10 Series Bases - continued



Part Number	Part Image	Price	Diameter	Description	Fits	Load Rating kg [lb]	Recommended Screw Fastener (ADC Part Number)		Pack Quantity	Material	Drawing Link		
							Core Hole Attachment <b>1</b>	**T-Slot Attachment <b>2</b>					
<a href="#">151257</a>		\$24.00	3.90 in [99.0 mm]	Swivel Base With Anti-Slip Plate	Any 15mm ball Threaded Rod	3500 [7716]	n/a	n/a	1	Die-cast zinc	<a href="#">PDF</a>		
<a href="#">151258</a>		\$24.00									<a href="#">PDF</a>		
<a href="#">162933</a>		\$12.50	See Drawing Link	Extended Swivel Base	Any 15mm ball Threaded Rod	1000 [2204]				n/a	1	Nylon	<a href="#">PDF</a>
<a href="#">162934</a>		\$27.00				3000 [6613]				Die-cast zinc		<a href="#">PDF</a>	
<a href="#">162955</a>		\$10.00	n/a	Floor Bracket	1 x 1in, 1 x 2in, 2 x 2in	n/a	<a href="#">151040</a>		Anodized aluminum	<a href="#">PDF</a>			

\*Based on installation with Transport / Base Plate  
Load rating of a swivel foot assembly is based on the part with the lowest load rating, typically the threaded rod.

Example:

Threaded rod load rating = 210kg [463lb]

Swivel base load rating = 3000kg [6614lb]

Swivel foot assembly load rating = 210kg [463lb]



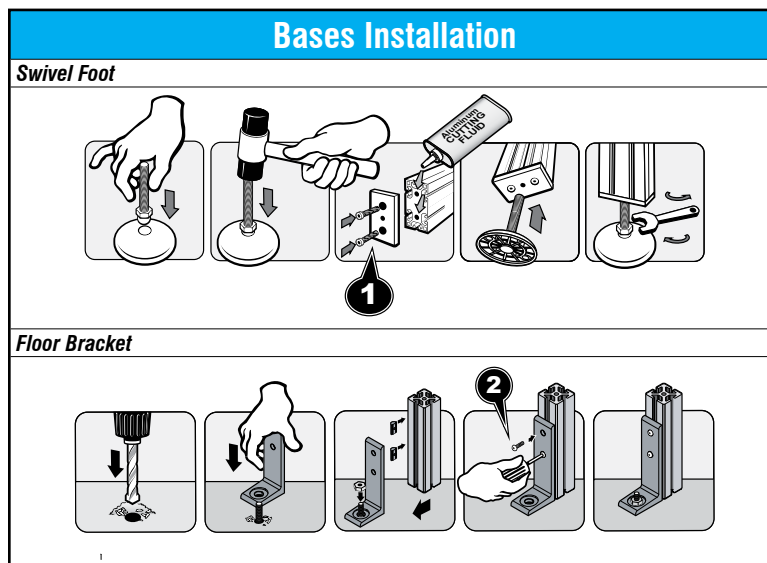

\*\*T-Slot nut also required

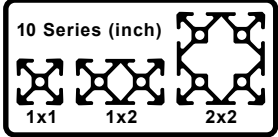

# FATH® T-Slotted Rail Accessories

## Casters

- Recommended ADC Fastener based on part feature and attachment type
- Material: varies by part

10 Series Casters									
Fits 									
Part Number	Part Image	Price	Description	Load Rating kg [lb]	Requires	Recommended Screw Fastener *T-Slot Attachment <b>2</b> (ADC Part Number)	Pack Quantity	Material	Drawing Link
<a href="#">163010</a>		\$40.00	Leveling Caster with M12-1.75 x 35mm threaded stud (included)	250 [551]	Transport / Base Plate with M12-1.75 threaded hole	n/a	1	Die-cast aluminum/ steel/nylon/ rubber	<a href="#">PDF</a>
<a href="#">163011</a>		\$52.00		500 [1102]					<a href="#">PDF</a>
<a href="#">163012</a>		\$41.00	Leveling Caster With Mounting Plate	250 [551]	n/a	BHCS 1/4-20x7/16" (not sold by ADC)			<a href="#">PDF</a>
<a href="#">163013</a>		\$56.00		500 [1102]					<a href="#">PDF</a>

\*T-Slot Nut with 1/4 washer also required.

### Caster Installation

**Leveling Caster with M12-1.75 x 35mm threaded stud**

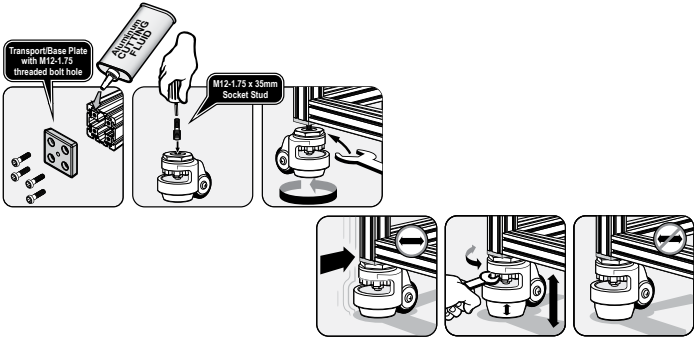

**Leveling Caster with mounting plate**

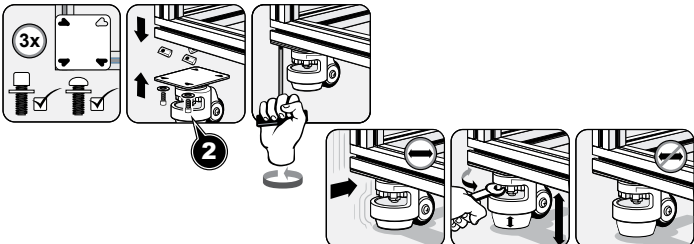







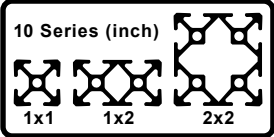

# FATH® T-Slotted Rail Accessories

## Hinges

- Recommended ADC Fastener based on part feature and slot depth
- Material: varies by part



10 Series Hinges							
Fits		Slot Size 					
Part Number	Part Image	Price	Description	Recommended Screw Fastener *T-Slot Attachment (ADC Part Number)	Pack Quantity	Material	Drawing Link
<a href="#">151076</a>		\$6.00	Left-Hand Detachable Combination Hinge	<a href="#">161074</a>	1	Fiberglass reinforced plastic	<a href="#">PDF</a>
<a href="#">151077</a>		\$6.00	Right-Hand Detachable Combination Hinge				<a href="#">PDF</a>
<a href="#">151078</a>		\$6.00	Non-Detachable Combination Hinge				<a href="#">PDF</a>
<a href="#">151079</a>		\$11.50	Non-Detachable Combination Hinge With Locking Lever				<a href="#">PDF</a>
<a href="#">151080</a>		\$17.00	Left-Hand Detachable Combination Hinge			Die-cast aluminum	<a href="#">PDF</a>
<a href="#">151081</a>		\$17.00	Right-Hand Detachable Combination Hinge				<a href="#">PDF</a>
<a href="#">151082</a>		\$17.00	Non-Detachable Combination Hinge				<a href="#">PDF</a>

\*T-Slot Nut also required



# FATH® T-Slotted Rail Accessories

## Panel and Door Elements

- Recommended ADC Fastener based on part feature and slot depth
- Material: varies by part



10 Series Panel and Door Elements							
<p>Fits Slot Size 6</p>		<p>10 Series (inch) 1x1 1x2 2x2</p>					
Part Number	Part Image	Price	Description	Recommended Screw Fastener *T-Slot Attachment <b>2</b> (ADC Part Number)	Pack Quantity	Material	Drawing Link
<a href="#">151083</a>		\$4.25	Bridge Handle	<a href="#">162995</a>	1	Fiberglass reinforced plastic	<a href="#">PDF</a>
<a href="#">151084</a>		\$6.50	Cover Cap <b>3</b>	n/a			<a href="#">PDF</a>
<a href="#">151085</a>		\$4.50	Comfort Handle	<a href="#">161087</a>			<a href="#">PDF</a>
<a href="#">151086</a>		\$4.00	Cover Cap <b>3</b>	n/a			<a href="#">PDF</a>
<a href="#">151149</a>		\$6.50	Comfort Handle	<a href="#">151050</a>			<a href="#">PDF</a>
<a href="#">162910</a>		\$3.00	Panel Holder	<a href="#">151040</a>		Anodized aluminum	<a href="#">PDF</a>
<a href="#">162915</a>		\$5.25					<a href="#">PDF</a>
<a href="#">162920</a>		\$5.25	Panel Mount Block	Fasteners included		Lacquered aluminum	<a href="#">PDF</a>
<a href="#">162921</a>		\$5.25					<a href="#">PDF</a>
<a href="#">162963</a>		\$8.50	Magnetic Catch	<a href="#">161047</a>		Nylon/steel	<a href="#">PDF</a>
<a href="#">162977</a>		\$8.50	Hanger	<a href="#">151040</a>	Die-cast zinc	<a href="#">PDF</a>	
<a href="#">151087</a>		\$110.00	Cover And Reduction Profile, 2000mm long per piece	n/a	25	Polypropylene	<a href="#">PDF</a>

\*T-Slot Nut also required

# FATH® T-Slotted Rail Accessories





## Panel and Door Elements - Continued

Panel and Door Elements Installation	
<b>Bridge Handle and Cover Cap</b>	
<b>Comfort Handle and Cover Cap</b>	
<b>Cover and Reduction Profile</b>	
<b>Panel Holder</b>	
<b>Hanger</b>	
<b>Magnetic Catch</b>	
<b>Panel Mount Block</b>	

# FATH® T-Slotted Rail Accessories

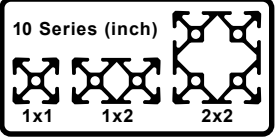
## Slides and Rollers



10 Series Slides and Rollers							
		Fits  Slot Size 6					
Part Number	Part Image	Price	Description	Fits	Pack Quantity	Material	Drawing Link
<a href="#">151090</a>		\$7.25	Roller	All 10 Series	1	Glass-filled nylon	<a href="#">PDF</a>
<a href="#">151088</a>		\$4.50	Slider			Glass-filled nylon	<a href="#">PDF</a>
<a href="#">151089</a>		\$4.50	Snap Hook	Slider <a href="#">151088</a>		Zinc plated steel	<a href="#">PDF</a>

### Slides and Rollers Installation

**Roller**

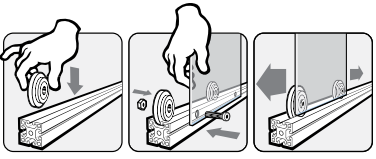



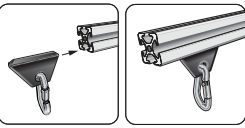

**Slider and Snap Hook**

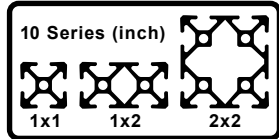
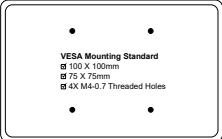

# FATH® T-Slotted Rail Accessories

## Monitor Mounts

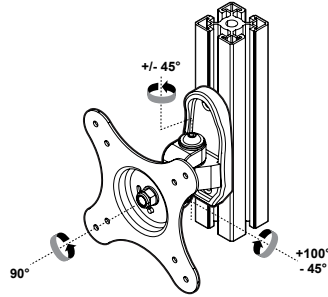
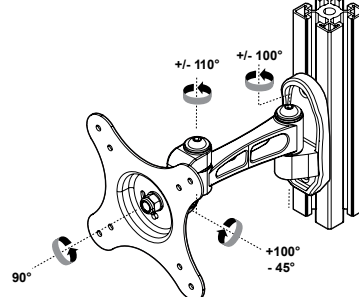
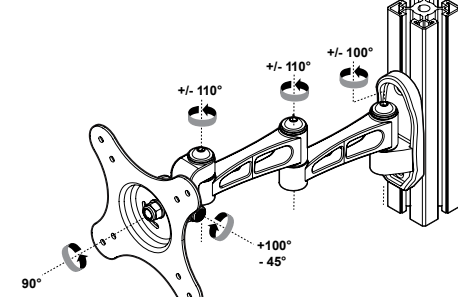

10 Series Monitor Mounts							
<ul style="list-style-type: none"> <li>Fits monitors with VESA mounting standard</li> <li>Durable steel construction</li> <li>Powder coat finish</li> <li>Mounting hardware included for several mounting locations</li> </ul>		Fits  Slot Size 6					
Part Number	Part Image	Price	Description	Load Rating kg [lb]	Pack Quantity	Installation Instructions Link	Drawing Link
<a href="#">162893</a>		\$42.00	Swivel Monitor Mount	15 [33.1]	1	<a href="#">PDF</a>	<a href="#">PDF</a>
<a href="#">162894</a>		\$50.00				<a href="#">PDF</a>	<a href="#">PDF</a>
<a href="#">162895</a>		\$58.00				<a href="#">PDF</a>	<a href="#">PDF</a>

Monitor Mounts Adjustments		
 <p><b>162893</b></p>	 <p><b>162894</b></p>	 <p><b>162895</b></p>

# FATH® T-Slotted Rail Accessories

## Wire Management



10 Series Wire Management							
Fits		Slot Size <b>6</b>					
Part Number	Part Image	Price	Description	Pack Quantity	Recommended Screw Fastener *T-Slot Attachment <b>2</b> (ADC Part Number)	Material	Drawing Link
<a href="#"><b>151095</b></a>		\$44.00	Clip Cable Binder With Hammer	10	n/a	Nylon/rubber	<a href="#">PDF</a>
<a href="#"><b>162982</b></a>		\$7.50	Universal Cable Binder Block		<a href="#">162993</a>	Nylon	<a href="#">PDF</a>

\*T-Slot Nut also required

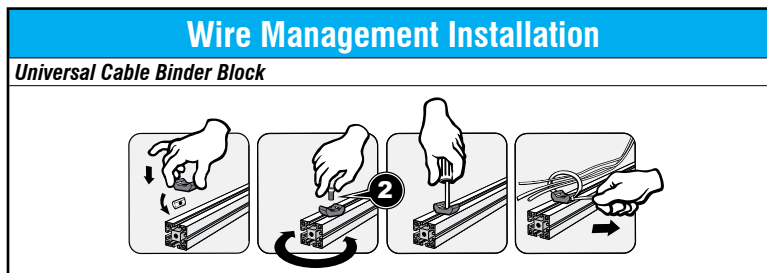

# FATH® T-Slotted Rail Accessories

## Miscellaneous Accessories



### 10 Series Miscellaneous Accessories

Fits Slot Size 6

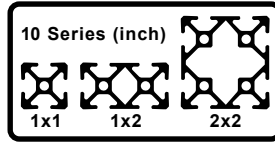

Part Number	Part Image	Price	Description	Fits Profile	Recommended Screw Fastener *T-Slot Attachment <b>2</b> (ADC Part Number)	Pack Quantity	Material	Drawing Link
<a href="#">151092</a>		\$10.00	End Cap	1 x 1in	n/a	10	Glass-filled nylon	<a href="#">PDF</a>
<a href="#">151093</a>		\$14.50		1 x 2in				<a href="#">PDF</a>
<a href="#">151094</a>		\$19.00		2 x 2in				<a href="#">PDF</a>
<a href="#">162973</a>		\$3.25	Sensor Mounting Block for 8mm diameter proximity sensor	All 10 Series	BHCS 8-32 x 3/4" (not sold by ADC)	1	Nylon	<a href="#">PDF</a>
<a href="#">162974</a>		\$3.25	Sensor Mounting Block for 12mm diameter proximity sensor					<a href="#">PDF</a>

\*T-Slot Nut also required

### Miscellaneous Accessories Installation

**Sensor Mounting Block**