

STAHL Intrinsicly Safe Isolators



Overview

STAHL's easy-to-connect and user-friendly isolating barriers provide intrinsic safety and galvanic separation between the control system and the field device, insulating the field device from other parts of the system. Their isolating barrier range is easy to use and boasts an impressive range of functions and a long service life.

Features

- Compact: Dual Channel modules for most functions
- Analog cards are HART capable
- Analog and digital cards are rated for SIL applications
- pac-Bus provides time-saving system for wiring

STAHL Intrinsicly Safe Isolators Selection Guide

Part Number	Price	Isolator Type	Field Device	Channels	Controller Side (PLC/DCS)	Drawing
Analog Input (From Hazardous Area)						
9260-13-11-10S	\$471.00	Transmitter (1 channel)	0 to 20 mA or 4 to 20 mA	1 in / 1 out	Output range will match input range (active or passive)	PDF
9260-19-11-10S	\$665.00	Transmitter (splitter)	0 to 20 mA or 4 to 20 mA	1 in / 2 out	Output range will match input range (active)	PDF
9260-23-11-10S	\$746.00	Transmitter (2 channel)	0 to 20 mA or 4 to 20 mA	2 in / 2 out	Output range will match input range (active)	PDF

Analog Output (To Hazardous Area)						
9165-16-11-11S	\$526.00	Isolating repeater	Output range will match input range (active)	1 in / 1 out	0 to 20 mA or 4 to 20 mA	PDF
9265-26-11-10S	\$750.00	Isolating repeater	Output range will match input range (active)	2 in / 2 out	0 to 20 mA or 4 to 20 mA	PDF

Digital Input (From Hazardous Area)						
9270-11-16-14S	\$291.00	Switching repeater, 1 channel DC power	NAMUR sensor* or dry contacts	1 in / 1 out	1 changeover contact (SPDT relay)	PDF
9170-11-13-21S	\$212.00	Switching repeater, 1 channel AC power	NAMUR sensor* or dry contacts	1 in / 2 out	2 changeover contacts (2 SPDT relays)	PDF
9270-21-17-14S	\$337.00	Switching repeater, 2 channel DC power	NAMUR sensor* or dry contacts	2 in / 2 out	1 NO relay (max 250V / 2A)	PDF
9170-21-12-21S	\$261.00	Switching repeater, 2 channel AC power	NAMUR sensor* or dry contacts	2 in / 2 out	1 changeover contact (SPDT relay)	PDF
9172-20-11-00S	\$285.00	Ex i relay module (2 channel)	Intrinsically safe coil (14 to 30 V)	2 in / 2 out	1 changeover contact (SPDT relay)	PDF

Digital Output (To Hazardous Area)						
9275-10-24-48-11S	\$351.00	Digital output	Open circuit: 24.3 V 48mA at 9.7 V	1 in / 1 out	15 to 30 V for ON 0 to 5 V for OFF	PDF
9175-20-14-11S	\$490.00	Digital output	Open circuit: 17.5 V 43mA at 12V	2 in / 2 out	15 to 31.2 V for ON 0 to 5 V for OFF	PDF

Temperature Converter (From Hazardous Area)						
9182-10-51-11S	\$602.00	Temperature transmitter	Thermocouple and RTD	1 in / 1 out	0 to 20 mA or 4 to 20 mA (active)	PDF
9180-10-77-11S	\$506.00	RTD repeater	RTD (PT 100)	1 in / 1 out	Equal to input signal (resistor)	PDF
9180-20-77-11S	\$740.00	RTD repeater	RTD (PT 100)	2 in / 2 out	Equal to input signal (resistor)	PDF

Frequency Transmitter (From Hazardous Area)						
9146-10-11-12S	\$743.00	Frequency transmitter	NAMUR sensor* or voltage pulses	1 in / 1 out	0 to 20 mA or 4 to 20 mA (active) with two configurable dry contacts	PDF
9146-20-11-11S	\$964.00	Frequency transmitter	NAMUR sensor* or voltage pulses	2 in / 2 out	0 to 20 mA or 4 to 20 mA (active)	PDF

* A NAMUR sensor is an intrinsically safe 2-wire sensor which supplies one of two signal levels depending on sensor state.

Part Number Nomenclature

9260-13-11-10S

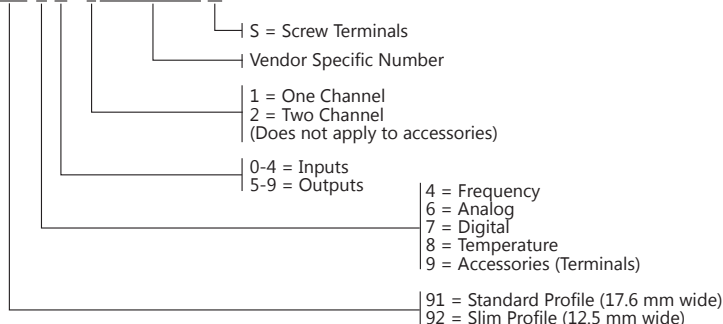

STAHL Intrinsicly Safe Isolators RTD Repeater



STAHL Intrinsicly Safe Isolators RTD Repeater Specifications

		9180-10-77-11S	9180-20-77-11S
Isolator Type		RTD repeater	RTD repeater
Explosion Protection	Installation Location (per NEC 500)	Class I, Division 2	Class I, Division 2
	Ex Interface (for intrinsically safe interface) (per NEC 500)	Class I, II, III Division 1 or 2	Class I, II, III Division 1 or 2
	Agency Approvals	ATEX (BVS), Brazil (ULB), Canada (FM), EAC (ENDCE), IECEx (BVS), India (PESO), Korea (KTL), Russia (Meteorological certificate), USA (FM)	ATEX (BVS), Brazil (ULB), Canada (FM), EAC (ENDCE), IECEx (BVS), India (PESO), Korea (KTL), Russia (Meteorological certificate), USA (FM)
Safety Data	Max Voltage (U_0)	6.5 V	6.5 V
	Max Current (I_0)	16.4 ma	16.4 ma
	Max Power (P_0)	27mw	27mw
Functional Safety	Safety Integrity Level (SIL)	-	-
Electrical Data	Number of Channels	1 in / 1 out	2 in / 2 out
	Line Fault Detection Relay	Yes	Yes
	Auxiliary Power Range	18 to 31.2 VDC	18 to 31.2 VDC
	Nominal Current	27mA	37mA
	Power Consumption	0.65 W	0.89 W
	Max Power Dissipation	0.6 W	0.72 W
	Operation Indication	Green LED "PWR" and Red LED "LF"	Green LED "PWR" and Red LED "LF"
	Input Function	2-wire, 3-wire, or 4-wire circuits	2-wire, 3-wire, or 4-wire circuits
	Resistance Temperature Detector (RTD) Input Type	PT 100	PT 100
	Measuring range	18 to 391Ω	18 to 391Ω
	HART Compatible	No	No
Output	Equal to input signal (resistor)	Equal to input signal (resistor)	
Ambient Conditions	Operating Temperature (Group Assembly)	-20°C to 60°C [-4°F to 140°F]	-20°C to 60°C [-4°F to 140°F]
	Operating Temperature (Single Device Installation)	-20°C to 70°C [-4°F to 158°F]	-20°C to 70°C [-4°F to 158°F]
	Storage Temperature	-40°C to 80°C [-40°F to 176°F]	-40°C to 80°C [-40°F to 176°F]
Mechanical Data	Degree of Protection	IP20	IP20
	Width	17.6 mm [0.69 in] (standard)	17.6 mm [0.69 in] (standard)
	Mounting Type	DIN rail	DIN rail
	Wire Gauge Range	16 - 12 AWG	16 - 12 AWG
	Mounting Position	Vertical or horizontal	Vertical or horizontal
	Weight	0.35 lb [160g]	0.4 lb [180g]

Connection Diagrams

9180-10-77-11S

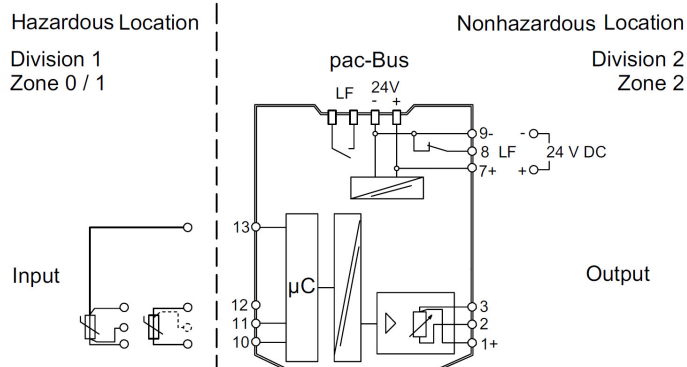

9180-20-77-11S

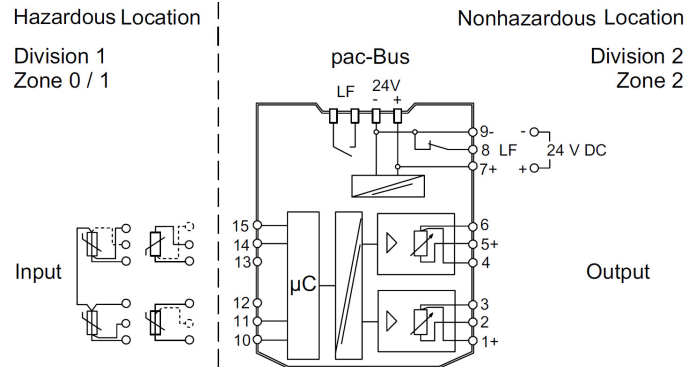

STAHL Intrinsicly Safe Isolators Accessories – pac-Bus System

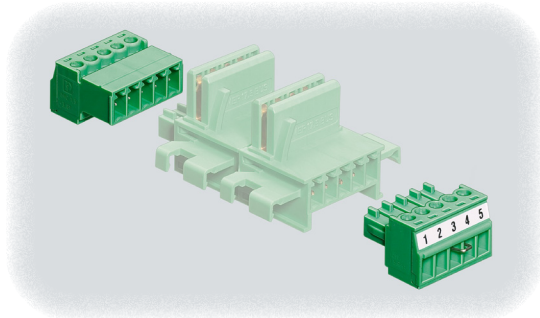

Benefits of Using the pac-Bus System

- Quick, easy wiring
- Can be installed on standard DIN rail without tools by simply snapping into place
- Can be expanded at any time with additional pac-Bus units
- Suitable for industrial environments subject to vibration
- Optional power supply module 9193 enables refused redundant 24VDC supply and fault signalization

STAHL Intrinsicly Safe Isolators Accessories (pac-Bus System) Selection Guide				
Part Number	Price	Description	Weight	Drawing
9194-50-01	\$22.50	End terminal set for pac-Bus system	0.29 oz [8 g]	PDF
9294-31-12	\$29.50	pac-Bus terminal for 92xx (12.5 mm [0.49 in] width) isolators	0.16 oz [5 g]	PDF
9194-31-17	\$22.50	pac-Bus terminal for 91xx (17.6 mm [0.69 in] width) isolators	0.16 oz [5 g]	PDF
9193/21-11-11S	\$269.00	pac-Bus supply module	0.4 lb [180g]	PDF
111412	\$40.00	Qty 10 spare fuses for use with pac-Bus supply module	0.07 lb [2g]	PDF

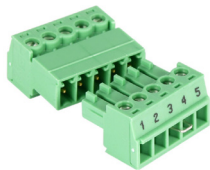

[9194-50-01](#)



[9294-31-12](#)

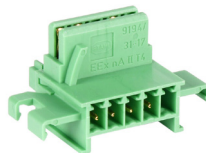

[9194-31-17](#)



[9193/21-11-11S](#)



[111412](#)

Connection Diagram

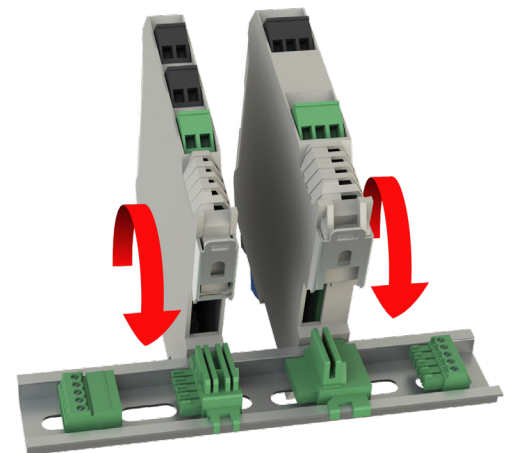
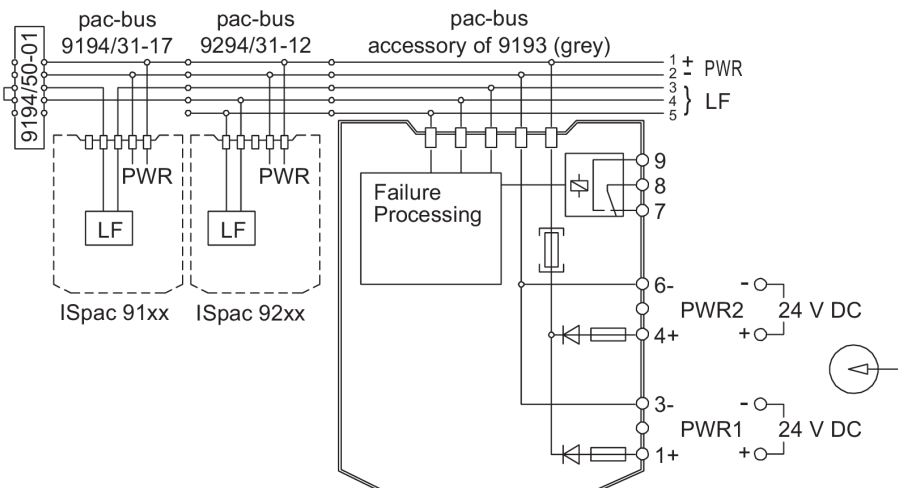

Refer to installation instructions for details

STAHL Intrinsically Safe Isolators Accessories – pac-Bus System



STAHL pac-Bus Supply Module Specifications		
9193/21-11-11S		
Explosion Protection	Installation Location (per NEC 500)	Class I, Division 2
	Ex Interface (for intrinsically safe interface) (per NEC 500)	Class I, II, III Division 1 or 2
	Agency Approvals	ATEX (BVS), Canada (FM), China (NEPSI), IECEx (BVS), India (PESO), USA (FM)
Electrical Data	Power Supply	24VDC 4A, primary and redundant
	Auxiliary Power Voltage Range	18.0 to 31.2 VDC
	Max Power Dissipation	2.5 W
Ambient Conditions	Operating Temperature	-40°C to 55°C [-40°F to 131°F]
	Storage Temperature	-40°C to 80°C [-40°F to 176°F]
Mechanical Data	Degree of Protection	IP20
	Mounting Type	DIN rail
	Wire Gauge Range	16AWG for terminals 12AWG for ground connections

Safety Products



Warning: Safety products sold by AutomationDirect are Safety components only. The purchaser/installer is solely responsible for the application of these components and ensuring all necessary steps have been taken to assure each application and use meets all performance and applicable safety requirements and/or local, national and/or international safety codes as required by the application. AutomationDirect cannot certify that our products, used solely or in conjunction with other AutomationDirect or other vendors' products, will assure safety for any application. Any person using or applying any products sold by AutomationDirect is responsible for learning the safety requirements for their individual application and applying them, and therefore assumes all risks, and accepts full and complete responsibility, for the selection and suitability of the product for their respective application.

AutomationDirect does not provide design or consulting services, and cannot advise whether any specific application or use of our products would ensure compliance with the safety requirements for any application.