

SureServo2

AC Servo Systems

Drive features

- Power:
 - 1 phase 110VAC: 100W-2kW
 - 1 phase 220VAC: 100W-2kW
 - 3 phase 220VAC: 100W-15kW
 - 3 phase 460VAC: 400W-15kW
- Fully digital with up to 3.1 kHz bandwidth velocity loop response
- Easy setup and diagnostics with built-in keypad/display or the SureServo2 Pro PC-based software
- Field upgradeable firmware ensures the drive can always be upgraded to the latest operating system
- Communications include:
 - Serial Modbus (native/built-in)
 - Optional Modbus TCP card
 - Optional Ethernet/IP card (this card can use implicit and explicit messaging. SureServo2 Pro software can generate an EDS file to transfer custom data between PLC and drive)
- Command options include:
 - \pm 10V torque or velocity command
 - Pulse train or master encoder position command (accepts line driver or open collector) with electronic gearing
 - Powerful built-in motion controller for position control using 99 preset positions (enter these during development, or send them through the communications options above during runtime)
 - Internal sequencing for position/speed



commands, registration (capture/compare), electronic camming, homing (10 different options), Jumps, and arithmetic statements.

- The 3.1 kHz bandwidth allows for high-level automatic tuning. Several modes of tuning are available including Auto Tune that can estimate the load inertia and fine-tune the system when all the loads are attached.
- Optically isolated digital inputs (10) and outputs (6), analog outputs for monitor signals (2), and line driver output for encoder (with scalable resolution).
- Other Features:
 - Secondary/Auxiliary encoder feedback (for true closed loop control)
 - Registration ability
 - Analog positioning
 - Safe Torque Off (STO) included - so no need for large, bulky contactors to disconnect power from the drive in E-stop situations
 - Absolute Encoder operation (with optional encoder battery backup)
 - Electronic camming (you can define the cam with SureServo2 Pro software or you can import an Excel spreadsheet)
 - Advanced Scope feature that can monitor a variety of command and status signals, including output speed, torque, power, etc.

Motor features

- Low inertia models:
 - 100W, 200W, 400W, 750W, 1kW, 1.5 kW, and 2kW
 - Speeds up to 6,000 rpm
- Medium inertia models:
 - 1kW, 1.5 kW, 2kW, and 3kW
 - Speeds up to 3,000 rpm
- High inertia models:
 - 3kW, 4.5 kW, 5.5 kW, 7.5 kW, 11kW, and 15kW
 - Speeds up to 3,000 rpm
- Permanent magnet 3-phase synchronous motor
- Keyed drive shafts support clamp-on style couplings or key-style couplings
- Integrated encoder with 16,777,216 encoder pulses/revolution plus marker pulse (once per revolution)
- Optional 24 VDC spring-set holding brakes (xxxxB series motors)
- Standard hook-up cables for motor power, encoder, and brake (separate brake cable for brake motors 230V systems 5.5kW and larger or 460V systems 11kW and larger)
- Motor cables available in standard or flex-rated lengths of 3, 5, 10, and 20m
- Standard 50-pin DIN-rail mounted break-out kit for the drive's CN1 connector (with screw terminal connections), or 20-pin spring clamp terminal block (limited I/O) that mounts directly to the drive

SureServo2 tuning technology

The SureServo2 drive closes the loop on current, velocity, and position (depending on control mode selection). The 3.1 kHz bandwidth in the drive assures precise speed and current control and easy tuning. Proportional gain, integral gain and compensation, feed forward compensation, command low pass filter, and five (5) notch filters for resonance suppression are available. Auto Tuning has been greatly improved and can easily tune systems with as much as 60:1 inertia mismatch.

There is an inertia estimation function that analyzes the motor and load to measure how much inertia is coupled to the motor.

The drive has several tuning methods available:

- One Touch Auto Tuning—the drive tunes the motor without any motion (static motor/system analysis)
- Normal Auto Tuning—the drive tunes the load while an external controller or the drive's internal indexer provides point-to-point moves
- Assisted Tuning—3 modes where the drive tunes the motor while moving. The user can adjust responsiveness while the drive is analyzing the system
- Manual Tuning—20+ parameters are available to give power users the ultimate flexibility to tune their systems.

SureServo2 Built-in motion controller

While the SureServo2 drives can accept traditional commands from host controls, they can also provide their own internal motion control. For example, up to 99 index moves can be pre-defined and stored in the drive and then selected and executed using digital inputs (inputs as events or inputs used as a multiplexer) or communication (serial Modbus, Modbus TCP, or Ethernet/IP). The index profiles can also be changed while in-process with digital events or via comms. The internal motion can consist of incremental or absolute moves, and can be sequenced internally with delays in between the moves or moves can be linked together so they are processed one after the other.

Multi-axis systems can be controlled via digital inputs, or serial/Ethernet communication. The motion can be commanded from a powerful external controller that sends out high speed pulses to each drive, or the motion can be initiated by a low-level controller (the simple CLICK PLC) since each drive has a powerful motion controller inside. Applications include press feeds, auger fillers, rotary tables, robots for pick and place, test or assembly operations, drilling, cutting, tapping, and similar applications using simple index moves for single or multi-axis motion.

SureServo2

Optional Holding Brake

Each SureServo2 motor rating can be ordered with an optional 24VDC spring-set holding brake that holds the motor in place when power is removed.

SureGear® Precision Gearboxes for Servo motors

Inertia balancing issue in your design?

The SureGear PGA series easily mates to SureServo2 motors. Everything you need to mount your SureServo2 motor is included!



- Four gear ratios available (5, 10, 15, 25:1)
- Mounting hardware included for attaching to SureServo2 motors
- Industry-standard mounting dimensions
- Thread-in mounting style
- Best-in-class backlash (5 arc-min)
- 5-year warranty

How to select and apply SureServo2 systems

The primary purpose of the AC servo system is to precisely control the motion of the load. The most fundamental considerations in selecting the servo system are “reflected” load inertia, servo system maximum speed requirement, servo system continuous torque requirement, and servo system peak torque requirement. In a retrofit application, select the largest torque SureServo2 system that most closely matches these parameters for the system being replaced. In a new application, these parameters should be determined through calculation and/or measurement. SureServo2 Pro has the ability to measure the load (reflected) inertia and accurately measure the motor torque output.

AutomationDirect has teamed with Copperhill Technologies to provide free servo-sizing software. “VisualSizer-SureServo” software will assist in determining the correct motor and drive for your application by calculating the reflected load inertia and required speed and torque based on the load configuration. “VisualSizer-SureServo” software can be downloaded from www.automationdirect.com on the store page for your drive.

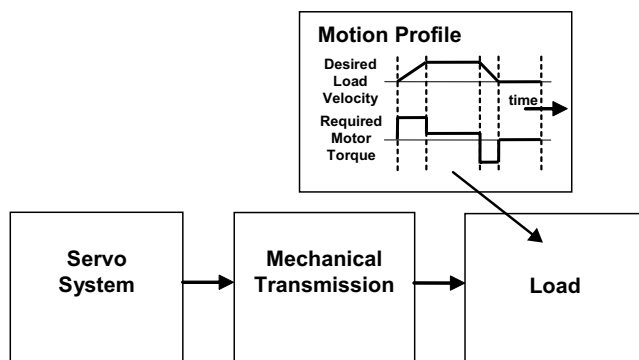

1. “Reflected” load inertia

The inertia of everything attached to the servo motor driveshaft needs to be considered and the total “reflected” inertia needs to be determined. This means that all elements of any mechanical transmission and load inertia need to be translated into an equivalent inertia as if attached directly to the motor driveshaft. The ratio of “reflected” load inertia to motor inertia needs to be carefully considered when selecting the servo system.

In general, applications that need high response or bandwidth will benefit from keeping the ratio of load inertia to motor inertia as low as possible and ideally under 10:1. Systems with ratios as high as 200:1 can be implemented, but corresponding lower bandwidth or responsiveness must be accepted. The servo response including the attached load inertia is determined by the servo tuning. SureServo2 systems may be tuned manually, fully Automatically, or via a hybrid mode where the software tunes the system with input for system responsiveness from the user.

2. Torque and speed

With knowledge of the motion profile and any mechanical transmission between the motor and load, calculations can be made to determine the required servo motor continuous torque, peak torque, and maximum motor speed. The required amount of continuous torque must fall inside the continuous operating region of the system torque-speed curve (you can check the continuous torque at the average speed of the motion profile). The required amount of peak torque must also fall within the servo system’s intermittent operating region of the system torque-speed curve (you need to check this value at the required maximum speed or torque). If you have a SureServo2 system, these values are easily captured and recorded with the Scope feature built into SureServo2 Pro. If you are designing the system, use VisualSizer to define the system and calculate expected inertia and required power.

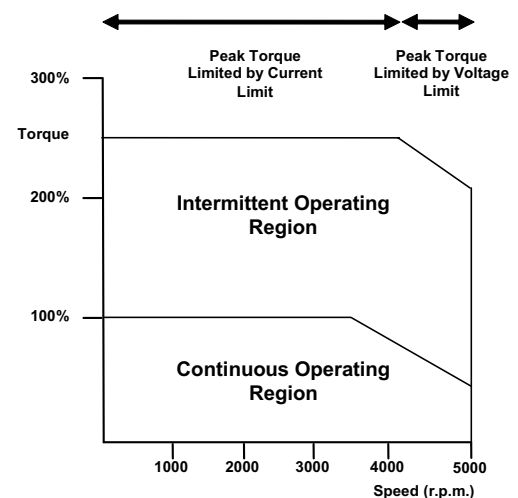



AC Servo Systems

Application tip - coupling considerations

The SureServo2 motors have keyed shafts that can be used with keyed couplings or with clamp-on or compression style couplings. "Servo-grade" clamp-on or compression style couplings are usually the best choice when you consider the stiffness, torque rating, and inertia. Higher stiffness

(lb-in/radian) is needed for better response but there is a trade-off between the stiffness and the added inertia of the coupling. Concerning the torque rating of the coupling, use a safety factor of 1.25 over the SureServo2 **peak** torque requirement of your application.

Available Couplings

Mechanical transmissions

Common mechanical transmissions include leadscrews, rack & pinion mechanisms, conveyors, gears, and timing belts. The use of leadscrew, rack & pinion, or conveyor are common ways to translate the rotary motion of the servo motor into linear motion of the load. The use of a speed reducer such as a gearbox or timing belt can be very beneficial as follows:

1. Reduction of reflected load inertia

As a general rule, it is beneficial to keep the reflected load inertia as low as possible while using the full range of servo speed. SureServo2 systems can go up to 6,000 rpm for the low inertia motors and up to 3,000 rpm for the medium inertia motors.

Example: A gearbox reduces the required torque by a factor of the gear ratio, and reduces the reflected load inertia by a factor of the gear ratio squared. A 10:1 gearbox reduces output speed to 1/10, increases output torque 10 times, and decreases reflected inertia to 1/100.

However, when investigating the effect of different speed reduction ratios DO NOT forget to include the added inertia of couplings, gearbox, or timing belt pulleys. These added inertias can be significant, and can negate any inertia reduction due to the speed reduction.

2. Low speed and high torque applications

If the application requires low speed and high torque then it is common to introduce a speed reducer so that the servo system can operate over more of the available speed range. This could also have the added benefit of reducing the servo motor torque requirement which could allow you to use a smaller and lower cost servo system. Additional benefits are also possible with reduction in reflected inertia, increased number of motor encoder counts at the load, and increased ability to reject load disturbances due to mechanical advantage of the speed reducer.

3. Space limitations and motor orientation

SureServo2 motors can be mounted in any orientation, but the shaft seal should not be immersed in oil (open-frame gearbox, etc.). Reducers can possibly allow the use of a smaller motor or allow the motor to be repositioned. For example, some reducers would allow for in-line, right angle, or parallel mounting of the motor.

For more information, refer to the website listed below.

Mechanical Transmission: Timing Belts and Pulleys Precision Gearboxes

Ordering guide instructions

The following four pages are your ordering guide for SureServo2 systems. Each system has a torque-speed curve included for reference. This is the fundamental information that you need to select the servo motor and matching drive for your application.

Each system needs:

- Motor
- Drive
- Motor Power Cable
- Motor Encoder Cable
- I/O connections (either CN1 cable + RTB breakout board, or an LTB20 breakout board that mounts on the drive)
- For brakemotors 4.5 kW and below, the brake wiring is included in the power cable. For brakemotors 5.5 kW and above, a separate brake cable is required.

A wide variety of optional accessories are also available, such as Ethernet cards, RS485 splitters/terminators, toroids, etc.

You can also use the SureServo2 selector tool on the AutomationDirect.com website to help you configure your system.



AC Servo System Configuration

Torque to SureServo2 System Quick Reference

230V System Torque			
System Rated Torque (N-m)	System Maximum Torque (N-m)	Suggested Servo Motor	Required Servo Drive
0.32	1.12	SV2L-201N or SV2L-201B	SV2A-2040
0.64	2.24	SV2L-202N or SV2L-202B	SV2A-2040
1.27	3.96	SV2L-204N or SV2L-204B	SV2A-2040
2.39	7.86	SV2L-207N or SV2L-207B	SV2A-2075
3.18	8.12	SV2L-210N or SV2L-210B	SV2A-2150
4.77	14.32	SV2M-210N or SV2M-210B	SV2A-2150
7.16	14.88	SV2M-215N or SV2M-215B	SV2A-2150
9.55	24.54	SV2M-220N or SV2M-220B	SV2A-2200
17.55	48.29	SV2M-230N or SV2M-230B	SV2A-2300
28.65	71.62	SV2H-245N or SV2H-245B	SV2A-2550
35.01	87.53	SV2H-255N or SV2H-255B	SV2A-2550
47.74	119.36	SV2H-275N or SV2H-275B	SV2A-2750
70	175	SV2H-2B0N or SV2H-2B0B	SV2A-2F00
95.4	224.0	SV2H-2F0N or SV2H-2F0B	SV2A-2F00

460V System Torque			
System Rated Torque (N-m)	System Maximum Torque (N-m)	Suggested Servo Motor	Required Servo Drive
1.27	4.45	SV2L-404N or SV2L-404B	SV2A-4040
2.24	7.58	SV2L-407N or SV2L-407B	SV2A-4075
3.18	9.54	SV2L-410N or SV2L-410B	SV2A-4150
4.77	14.32	SV2M-410N or SV2M-410B	SV2A-4150
7.16	18.1	SV2L-415N or SV2L-415B	SV2A-4150
9.55	28.65	SV2L-420N or SV2L-420B	SV2A-4200
19.1	49.38	SV2H-430N or SV2H-430B	SV2A-4300
28.65	64.61	SV2H-445N or SV2H-445B	SV2A-4550
35.01	73.48	SV2H-455N or SV2H-455B	SV2A-4550
47.74	93.71	SV2H-475N or SV2H-475B	SV2A-4750
70	175	SV2H-4B0N or SV2H-4B0B	SV2A-4F00
95.4	224.0	SV2H-4F0N or SV2H-4F0B	SV2A-4F00



AC Servo System Configuration

SureServo2 AC servo drive, motor, and cable combinations

	Input Voltage	Torque Chart	SureServo2 Motor	SureServo2 Drive	Power Cable*	Encoder Cable*
100W Low Inertia System	120V		SV2L-201N	SV2A-2040	SV2C-PA18-xxNN	SV2C-E122-xxNN
			SV2L-201B		SV2C-PA18-xxFN	SV2C-E122-xxFN
	230V		SV2L-201N		SV2C-PA18-xxNN	SV2C-E122-xxNN
			SV2L-201B		SV2C-PA18-xxFN	SV2C-E122-xxFN
200W Low Inertia System	120V		SV2L-202N	SV2A-2040	SV2C-PA18-xxNN	SV2C-E122-xxNN
			SV2L-202B		SV2C-PA18-xxFN	SV2C-E122-xxFN
	230V		SV2L-202N		SV2C-PA18-xxNN	SV2C-E122-xxNN
			SV2L-202B		SV2C-PA18-xxFN	SV2C-E122-xxFN

Note: "xx" in the cable part numbers represents cable length: SV2C-xxxx-10xx is a 10m cable.

The final two digits indicate flex rating and motor brake compatibility:

SV2C-xxxx-xxNN is a non-flex, non-brake motor cable

SV2C-xxxx-xxNB is a non-flex, brake motor cable

SV2C-xxxx-xxFN is a flex-rated, non-brake cable

SV2C-xxxx-xxFB is a flex-rated, brake motor cable

All Systems I/O

SV2-CN1-CBL50xxx + SV2-CN1-RTB50



OR

SV2-CN1-LTB20





SureServo2 System Selector
Online



AC Servo System Configuration

SureServo2 AC servo drive, motor, and cable combinations, *continued*

Input Voltage	Torque Chart	SureServo2 Motor	SureServo2 Drive	Power Cable*	Encoder Cable*
120V		SV2L-204N	SV2A-2040	SV2C-PA18-xxNN	SV2C-E122-xxNN
				SV2C-PA18-xxFN	SV2C-E122-xxFN
		SV2L-204B		SV2C-PB18-xxNB	SV2C-E122-xxNN
				SV2C-PB18-xxFB	SV2C-E122-xxFN
230V		SV2L-204N	SV2A-2040	SV2C-PA18-xxNN	SV2C-E122-xxNN
				SV2C-PA18-xxFN	SV2C-E122-xxFN
		SV2L-204B		SV2C-PB18-xxNB	SV2C-E122-xxNN
				SV2C-PB18-xxFB	SV2C-E122-xxFN
460V		SV2L-404N	SV2A-4040	SV2C-PA18-xxNN	SV2C-E122-xxNN
				SV2C-PA18-xxFN	SV2C-E122-xxFN
		SV2L-404B		SV2C-PB18-xxNB	SV2C-E122-xxNN
				SV2C-PB18-xxFB	SV2C-E122-xxFN

Note: "xx" in the cable part numbers represents cable length: SV2C-xxxx-10xx is a 10m cable.
 The final two digits indicate flex rating and motor brake compatibility:
 SV2C-xxxx-xxNN is a non-flex, non-brake motor cable SV2C-xxxx-xxFN is a flex-rated, non-brake cable
 SV2C-xxxx-xxNB is a non-flex, brake motor cable SV2C-xxxx-xxFB is a flex-rated, brake motor cable

All Systems I/O

SV2-CN1-CBL50xxx + SV2-CN1-RTB50

OR

SV2-CN1-LTB20



SureServo2 System Selector
[Online](#)



AC Servo System Configuration

SureServo2 AC servo drive, motor, and cable combinations, *continued*

750W Low Inertia System	Input Voltage	Torque Chart	SureServo2 Motor	SureServo2 Drive	Power Cable*	Encoder Cable*
	120V		SV2L-207N	SV2A-2075	SV2C-PA18-xxNN	SV2C-E122-xxNN
			SV2L-207B		SV2C-PA18-xxFN	SV2C-E122-xxFN
	230V		SV2L-207N	SV2A-2075	SV2C-PA18-xxNN	SV2C-E122-xxNN
SV2L-207B			SV2C-PA18-xxFN		SV2C-E122-xxFN	
460V		SV2L-407N	SV2A-4075	SV2C-PA18-xxNN	SV2C-E122-xxNN	
		SV2L-407B		SV2C-PA18-xxFN	SV2C-E122-xxFN	
				SV2C-PB18-xxNB	SV2C-E122-xxNN	
				SV2C-PB18-xxFB	SV2C-E122-xxFN	

Note: "xx" in the cable part numbers represents cable length: SV2C-xxxx-10xx is a 10m cable.
 The final two digits indicate flex rating and motor brake compatibility:
 SV2C-xxxx-xxNN is a non-flex, non-brake motor cable SV2C-xxxx-xxFN is a flex-rated, non-brake cable
 SV2C-xxxx-xxNB is a non-flex, brake motor cable SV2C-xxxx-xxFB is a flex-rated, brake motor cable

All Systems I/O

SV2-CN1-CBL50xxx + SV2-CN1-RTB50



OR

SV2-CN1-LTB20





[SureServo2 System Selector Online](#)



AC Servo System Configuration

SureServo2 AC servo drive, motor, and cable combinations, *continued*

Input Voltage	Torque Chart	SureServo2 Motor	SureServo2 Drive	Power Cable*	Encoder Cable*
120V		SV2L-210N	SV2A-2150	SV2C-PC16-xxNN	SV2C-E222-xxNN
				SV2C-PC16-xxFN	SV2C-E222-xxFN
		SV2L-210B		SV2C-PC16-xxNB	SV2C-E222-xxNN
				SV2C-PC16-xxFB	SV2C-E222-xxFN
230V		SV2L-210N	SV2A-2150	SV2C-PC16-xxNN	SV2C-E222-xxNN
				SV2C-PC16-xxFN	SV2C-E222-xxFN
		SV2L-210B		SV2C-PC16-xxNB	SV2C-E222-xxNN
				SV2C-PC16-xxFB	SV2C-E222-xxFN
460V		SV2L-410N	SV2A-4150	SV2C-PC16-xxNN	SV2C-E222-xxNN
				SV2C-PC16-xxFN	SV2C-E222-xxFN
		SV2L-410B		SV2C-PC16-xxNB	SV2C-E222-xxNN
				SV2C-PC16-xxFB	SV2C-E222-xxFN

1.0 kW Low Inertia System

Note: "xx" in the cable part numbers represents cable length: SV2C-xxxx-10xx is a 10m cable.

The final two digits indicate flex rating and motor brake compatibility:

SV2C-xxxx-xxNN is a non-flex, non-brake motor cable

SV2C-xxxx-xxFN is a flex-rated, non-brake cable

SV2C-xxxx-xxNB is a non-flex, brake motor cable

SV2C-xxxx-xxFB is a flex-rated, brake motor cable

All Systems I/O

SV2-CN1-CBL50xxx + SV2-CN1-RTB50



OR

SV2-CN1-LTB20





SureServo2 System Selector
[Online](#)



AC Servo System Configuration

SureServo2 AC servo drive, motor, and cable combinations, *continued*

Input Voltage	Torque Chart	SureServo2 Motor	SureServo2 Drive	Power Cable*	Encoder Cable*	
120V		SV2M-210N	SV2A-2150	SV2C-PC12-xxNN	SV2C-E222-xxNN	
					SV2C-PC12-xxFN	SV2C-E222-xxFN
		SV2M-210B			SV2C-PC12-xxNB	SV2C-E222-xxNN
					SV2C-PC12-xxFB	SV2C-E222-xxFN
230V		SV2M-210N	SV2A-2150	SV2C-PC12-xxNN	SV2C-E222-xxNN	
					SV2C-PC12-xxFN	SV2C-E222-xxFN
		SV2M-210B			SV2C-PC12-xxNB	SV2C-E222-xxNN
					SV2C-PC12-xxFB	SV2C-E222-xxFN
460V		SV2M-410N	SV2A-4150	SV2C-PC16-xxNN	SV2C-E222-xxNN	
					SV2C-PC16-xxFN	SV2C-E222-xxFN
		SV2M-410B			SV2C-PC16-xxNB	SV2C-E222-xxNN
					SV2C-PC16-xxFB	SV2C-E222-xxFN

Note: "xx" in the cable part numbers represents cable length: SV2C-xxxx-10xx is a 10m cable.
 The final two digits indicate flex rating and motor brake compatibility:
 SV2C-xxxx-xxNN is a non-flex, non-brake motor cable SV2C-xxxx-xxFN is a flex-rated, non-brake cable
 SV2C-xxxx-xxNB is a non-flex, brake motor cable SV2C-xxxx-xxFB is a flex-rated, brake motor cable

All Systems I/O

SV2-CN1-CBL50xxx + SV2-CN1-RTB50

OR

SV2-CN1-LTB20



[SureServo2 System Selector Online](#)



AC Servo System Configuration

SureServo2 AC servo drive, motor, and cable combinations, *continued*

	Input Voltage	Torque Chart	SureServo2 Motor	SureServo2 Drive	Power Cable*	Encoder Cable*	
1.5 kW Medium Inertia System	120V		SV2M-215N	SV2A-2150	SV2C-PC12-xxNN	SV2C-E222-xxNN	
			SV2M-215B		SV2C-PC12-xxFN	SV2C-E222-xxFN	
	230V		SV2M-215N		SV2C-PC12-xxNN	SV2C-E222-xxNN	
			SV2M-215B		SV2C-PC12-xxNB	SV2C-E222-xxNN	
1.5 kW Low Inertia System	460V		SV2L-415N	SV2A-4150	SV2C-PC16-xxNN	SV2C-E222-xxNN	
			SV2L-415B		SV2C-PC16-xxFN	SV2C-E222-xxFN	
						SV2C-PC16-xxNB	SV2C-E222-xxNN
						SV2C-PC16-xxFB	SV2C-E222-xxFN

Note: "xx" in the cable part numbers represents cable length: SV2C-xxxx-10xx is a 10m cable.
 The final two digits indicate flex rating and motor brake compatibility:
 SV2C-xxxx-xxNN is a non-flex, non-brake motor cable SV2C-xxxx-xxFN is a flex-rated, non-brake cable
 SV2C-xxxx-xxNB is a non-flex, brake motor cable SV2C-xxxx-xxFB is a flex-rated, brake motor cable

All Systems I/O

SV2-CN1-CBL50xxx + SV2-CN1-RTB50



OR

SV2-CN1-LTB20





[SureServo2 System Selector Online](#)



AC Servo System Configuration

SureServo2 AC servo drive, motor, and cable combinations, *continued*

Input Voltage	Torque Chart	SureServo2 Motor	SureServo2 Drive	Power Cable*	Encoder Cable*
120V		SV2M-220N	SV2A-2200	SV2C-PD12-xxNN	SV2C-E222-xxNN
				SV2C-PD12-xxFN	SV2C-E222-xxFN
		SV2M-220B		SV2C-PD12-xxNB	SV2C-E222-xxNN
				SV2C-PD12-xxFB	SV2C-E222-xxFN
230V		SV2M-220N	SV2A-2200	SV2C-PD12-xxNN	SV2C-E222-xxNN
				SV2C-PD12-xxFN	SV2C-E222-xxFN
		SV2M-220B		SV2C-PD12-xxNB	SV2C-E222-xxNN
				SV2C-PD12-xxFB	SV2C-E222-xxFN
460V		SV2L-420N	SV2A-4200	SV2C-PC16-xxNN	SV2C-E222-xxNN
				SV2C-PC16-xxFN	SV2C-E222-xxFN
		SV2L-420B		SV2C-PC16-xxNB	SV2C-E222-xxNN
				SV2C-PC16-xxFB	SV2C-E222-xxFN

Note: "xx" in the cable part numbers represents cable length: SV2C-xxxx-10xx is a 10m cable.
 The final two digits indicate flex rating and motor brake compatibility:
 SV2C-xxxx-xxNN is a non-flex, non-brake motor cable SV2C-xxxx-xxFN is a flex-rated, non-brake cable
 SV2C-xxxx-xxNB is a non-flex, brake motor cable SV2C-xxxx-xxFB is a flex-rated, brake motor cable

All Systems I/O

SV2-CN1-CBL50xxx + SV2-CN1-RTB50

OR

SV2-CN1-LTB20



[SureServo2 System Selector Online](#)



AC Servo System Configuration

SureServo2 AC servo drive, motor, and cable combinations, *continued*

Input Voltage	Torque Chart	SureServo2 Motor	SureServo2 Drive	Power Cable*	Encoder Cable*
230V		SV2M-230N	SV2A-2300	SV2C-PD12-xxNN	SV2C-E222-xxNN
				SV2C-PD12-xxFN	SV2C-E222-xxFN
		SV2M-230B		SV2C-PD12-xxNB	SV2C-E222-xxNN
				SV2C-PD12-xxFB	SV2C-E222-xxFN
460V		SV2H-430N	SV2A-4300	SV2C-PD12-xxNN	SV2C-E222-xxNN
				SV2C-PD12-xxFN	SV2C-E222-xxFN
		SV2H-430B		SV2C-PD12-xxNB	SV2C-E222-xxNN
				SV2C-PD12-xxFB	SV2C-E222-xxFN

Note: "xx" in the cable part numbers represents cable length: SV2C-xxxx-10xx is a 10m cable.
 The final two digits indicate flex rating and motor brake compatibility:
 SV2C-xxxx-xxNN is a non-flex, non-brake motor cable SV2C-xxxx-xxFN is a flex-rated, non-brake cable
 SV2C-xxxx-xxNB is a non-flex, brake motor cable SV2C-xxxx-xxFB is a flex-rated, brake motor cable

All Systems I/O

SV2-CN1-CBL50xxx + SV2-CN1-RTB50

OR

SV2-CN1-LTB20



SureServo2 System Selector
Online



AC Servo System Configuration

SureServo2 AC servo drive, motor, and cable combinations, *continued*

Input Voltage	Torque Chart	SureServo2 Motor	SureServo2 Drive	Power Cable*	Encoder Cable*
230V		SV2H-245N	SV2A-2550	SV2C-PD08-xxNN	SV2C-E222-xxNN
				SV2C-PD08-xxFN	SV2C-E222-xxFN
		SV2H-245B		SV2C-PD08-xxNB	SV2C-E222-xxNN
				SV2C-PD08-xxFB	SV2C-E222-xxFN
460V		SV2H-445N	SV2A-4550	SV2C-PD08-xxNN	SV2C-E222-xxNN
				SV2C-PD08-xxFN	SV2C-E222-xxFN
		SV2H-445B		SV2C-PD08-xxNB	SV2C-E222-xxNN
				SV2C-PD08-xxFB	SV2C-E222-xxFN

Note: "xx" in the cable part numbers represents cable length: SV2C-xxxx-10xx is a 10m cable.
 The final two digits indicate flex rating and motor brake compatibility:
 SV2C-xxxx-xxNN is a non-flex, non-brake motor cable SV2C-xxxx-xxFN is a flex-rated, non-brake cable
 SV2C-xxxx-xxNB is a non-flex, brake motor cable SV2C-xxxx-xxFB is a flex-rated, brake motor cable

All Systems I/O

SV2-CN1-CBL50xxx + SV2-CN1-RTB50

OR

SV2-CN1-LTB20



[SureServo2 System Selector Online](#)



AC Servo System Configuration

SureServo2 AC servo drive, motor, and cable combinations, *continued*

Input Voltage	Torque Chart	SureServo2 Motor	SureServo2 Drive	Power Cable*	Encoder Cable*
230V		SV2H-255N	SV2A-2550	SV2C-PF06-xxNN	SV2C-E222-xxNN
				SV2C-PF06-xxFN	SV2C-E222-xxFN
		SV2H-255B		SV2C-PF06-xxNN and SV2C-B120-xxxx	SV2C-E222-xxNN
				SV2C-PF06-xxFN and SV2C-B120-xxxx	SV2C-E222-xxFN
460V		SV2H-455N	SV2A-4550	SV2C-PD08-xxNN	SV2C-E222-xxNN
				SV2C-PD08-xxFN	SV2C-E222-xxFN
		SV2H-455B		SV2C-PD08-xxNN	SV2C-E222-xxNN
				SV2C-PD08-xxFN	SV2C-E222-xxFN

Note: "xx" in the cable part numbers represents cable length: SV2C-xxxx-10xx is a 10m cable.
 The final two digits indicate flex rating and motor brake compatibility:
 SV2C-xxxx-xxNN is a non-flex, non-brake motor cable SV2C-xxxx-xxFN is a flex-rated, non-brake cable
 SV2C-xxxx-xxNB is a non-flex, brake motor cable SV2C-xxxx-xxFB is a flex-rated, brake motor cable

All Systems I/O

SV2-CN1-CBL50xxx + SV2-CN1-RTB50



OR

SV2-CN1-LTB20





SureServo2 System Selector
[Online](#)



AC Servo System Configuration

SureServo2 AC servo drive, motor, and cable combinations, *continued*

Input Voltage	Torque Chart	SureServo2 Motor	SureServo2 Drive	Power Cable*	Encoder Cable*
230V		SV2H-275N	SV2A-2750	SV2C-PF06-xxNN	SV2C-E222-xxNN
				SV2C-PF06-xxFN	SV2C-E222-xxFN
		SV2H-275B		SV2C-PF06-xxNN and SV2C-B120-xxxx	SV2C-E222-xxNN
				SV2C-PF06-xxFN and SV2C-B120-xxxx	SV2C-E222-xxFN
460V		SV2H-475N	SV2A-4750	SV2C-PD08-xxNN	SV2C-E222-xxNN
				SV2C-PD08-xxFN	SV2C-E222-xxFN
		SV2H-475B		SV2C-PD08-xxNN	SV2C-E222-xxNN
				SV2C-PD08-xxFN	SV2C-E222-xxFN

Note: "xx" in the cable part numbers represents cable length: SV2C-xxxx-10xx is a 10m cable.
 The final two digits indicate flex rating and motor brake compatibility:
 SV2C-xxxx-xxNN is a non-flex, non-brake motor cable SV2C-xxxx-xxFN is a flex-rated, non-brake cable
 SV2C-xxxx-xxNB is a non-flex, brake motor cable SV2C-xxxx-xxFB is a flex-rated, brake motor cable

All Systems I/O

SV2-CN1-CBL50xxx + SV2-CN1-RTB50

OR

SV2-CN1-LTB20



[SureServo2 System Selector Online](#)



AC Servo System Configuration

SureServo2 AC servo drive, motor, and cable combinations, *continued*

Input Voltage	Torque Chart	SureServo2 Motor	SureServo2 Drive	Power Cable*	Encoder Cable*
230V		SV2H-2B0N	SV2A-2F00	SV2C-PF06-xxNN	SV2C-E222-xxNN
				SV2C-PF06-xxFN	SV2C-E222-xxFN
		SV2H-2B0B		SV2C-PF06-xxNN and SV2C-B120-xxNB	SV2C-E222-xxNN
				SV2C-PF06-xxFN and SV2C-B120-xxFB	SV2C-E222-xxFN
460V		SV2H-4B0N	SV2A-4F00	SV2C-PF08-xxNN	SV2C-E222-xxNN
				SV2C-PF08-xxFN	SV2C-E222-xxFN
		SV2H-4B0B		SV2C-PF08-xxNN and SV2C-B120-xxNB	SV2C-E222-xxNN
				SV2C-PF08-xxFN and SV2C-B120-xxFB	SV2C-E222-xxFN

Note: "xx" in the cable part numbers represents cable length: SV2C-xxxx-10xx is a 10m cable.
 The final two digits indicate flex rating and motor brake compatibility:
 SV2C-xxxx-xxNN is a non-flex, non-brake motor cable SV2C-xxxx-xxFN is a flex-rated, non-brake cable
 SV2C-xxxx-xxNB is a non-flex, brake motor cable SV2C-xxxx-xxFB is a flex-rated, brake motor cable

All Systems I/O

SV2-CN1-CBL50xxx + SV2-CN1-RTB50

OR

SV2-CN1-LTB20



SureServo2 System Selector
[Online](#)

SureServo2 AC servo drive, motor, and cable combinations, *continued*

Input Voltage	Torque Chart	SureServo2 Motor	SureServo2 Drive	Power Cable*	Encoder Cable*
230V		SV2H-2F0N	SV2A-2F00	SV2C-PF04-xxNN	SV2C-E222-xxNN
				SV2C-PF04-xxFN	SV2C-E222-xxFN
		SV2H-2F0B		SV2C-PF04-xxNN and SV2C-B120-xxNB	SV2C-E222-xxNN
				SV2C-PF04-xxFB and SV2C-B120-xxFB	SV2C-E222-xxFN
460V		SV2H-4F0N	SV2A-4F00	SV2C-PF08-xxNN	SV2C-E222-xxNN
				SV2C-PF08-xxFN	SV2C-E222-xxFN
		SV2H-4F0B		SV2C-PF08-xxNN and SV2C-B120-xxNB	SV2C-E222-xxNN
				SV2C-PF08-xxFN and SV2C-B120-xxFB	SV2C-E222-xxFN

Note: "xx" in the cable part numbers represents cable length: SV2C-xxxx-10xx is a 10m cable.
 The final two digits indicate flex rating and motor brake compatibility:
 SV2C-xxxx-xxNN is a non-flex, non-brake motor cable SV2C-xxxx-xxFN is a flex-rated, non-brake cable
 SV2C-xxxx-xxNB is a non-flex, brake motor cable SV2C-xxxx-xxFB is a flex-rated, brake motor cable

All Systems I/O

SV2-CN1-CBL50xxx + SV2-CN1-RTB50

OR

SV2-CN1-LTB20



SureServo2 System Selector
Online

AC Servo Motor Specifications

Servo motor overview

24-bit Encoder Connector
1-foot cable with 9-position connector
(Motor-mounted connector is IP67, end-of-cable connector is not liquid tight)

IP67 Housing

Low Inertia Motors

- 100W 40 mm flange
- 200W 60 mm flange
- 400W 60 mm flange
- 750W 80 mm flange

750W and below

Motor Power and Brake Connector
1-foot cable with 6-position connector
(Motor-mounted connector is IP67, end-of-cable connector is not liquid tight)

Keyed Shafts

- 100W 8 mm diameter
- 200W 14 mm diameter
- 400W 14 mm diameter
- 750W 19 mm diameter

With Shaft Seal (liquid tight)

All SureServo2 motors have keyed shafts for use with servo-grade clamp or compression couplings (recommended) or servo-grade keyed couplings.

Motor Power and Brake Connector
(Liquid tight when using AutomationDirect cables)

24-bit Encoder Connector
(Liquid tight when using AutomationDirect cables)

IP67 Housing (IP65 connectors)

1 kW and above

Low, Medium, and High Inertia Motors

- Low Inertia Model:
 - 1kW 100mm flange
 - 1.5 kW 130mm flange
 - 2kW 130mm flange
- Medium Inertia Models:
 - 1kW 130mm flange
 - 1.5kW 130mm flange
 - 2kW 180mm flange
 - 3kW 180mm flange
- High Inertia Models:
 - 3.0kW 180mm flange
 - 4.5kW 180mm flange
 - 5.5kW 180mm flange
 - 7.5kW 180mm flange
 - 11kW 220mm flange
 - 15kW 220mm flange

Keyed Shafts

- Low Inertia Model:
 - 1kW 22mm diameter
 - 1.5 kW 22mm diameter
 - 2kW 22mm diameter
- Medium Inertia Models:
 - 1kW 22mm diameter
 - 1.5kW 22mm diameter
 - 2kW 35mm diameter
 - 3kW 35mm diameter
- High Inertia Models:
 - 3.0kW 35mm diameter
 - 4.5kW 35mm diameter
 - 5.5kW 42mm diameter
 - 7.5kW 42mm diameter
 - 11kW 42mm diameter
 - 15kW 55mm diameter

With Shaft Seal (liquid tight)



AC Servo Motor Specifications

230V Low Inertia Motor Specifications

230V SureServo2 Low Inertia Motor Specifications										
Model	SV2L-201N	SV2L-201B	SV2L-202N	SV2L-202B	SV2L-204N	SV2L-204B	SV2L-207N	SV2L-207B	SV2L-210N	SV2L-210B
Price	\$286.00	\$419.00	\$315.00	\$465.00	\$340.00	\$479.00	\$364.00	\$510.00	\$477.00	\$702.00
Drawing	PDF	PDF	PDF	PDF	PDF	PDF	PDF	PDF	PDF	PDF
Rated Power [kW]	0.1	0.1	0.2	0.2	0.4	0.4	0.75	0.75	1.0	1.0
Rated Torque [N·m]Note 1	0.32	0.32	0.64	0.64	1.27	1.27	2.39	2.39	3.18	3.18
Max. Torque [N·m]	1.12	1.12	2.24	2.24	3.96	3.96	7.86	7.86	8.12	8.12
Rated Speed [rpm]	3000									
Max. Speed [rpm]	6000								5000	
Rated current [Amps] rms	0.9	0.9	1.45	1.45	2.60	2.60	4.5	4.5	8.04	8.04
Max. Instantaneous Current [Amps] rms	3.3	3.3	5.4	5.4	8.56	8.56	15.41	15.41	20.16	20.16
Change of Rated Power [W/s]	16.3	14.90	16.4	14.60	35.8	33.60	37.8	34.40	38.2	30.40
Rotor Inertia [x10 ⁻⁴ kg m ²]	0.0627	0.0689	0.25	0.28	0.45	0.48	1.51	1.66	2.65	3.33
Mechanical Time Constant [ms]	1.13	1.24	1.38	1.54	0.94	1.01	0.91	1.00	0.83	1.05
Torque Constant-KT [N·m/A]	0.356	0.356	0.441	0.441	0.488	0.488	0.531	0.531	0.396	0.396
Voltage Constant-KE [mV/rpm]	13.66	13.66	16.4	16.4	17.2	17.2	18.7	18.7	16.8	16.8
Armature Resistance [Ohm]	8.34	8.34	3.8	3.8	1.68	1.68	0.57	0.57	0.20	0.20
Armature Inductance [mH]	9.85	9.85	8.15	8.15	4.03	4.03	2.2	2.2	1.81	1.81
Electrical Time Constant [ms]	1.18	1.18	2.14	2.14	2.40	2.40	3.86	3.86	9.05	9.05
Insulation Class	Class A (UL), Class B (CE)									
Insulation Resistance	> 100MΩ, 500VDC									
Insulation Strength	1.8 kVAC, 1 second									
Weight [kg]	0.5	0.8	1.1	1.6	1.4	1.9	2.8	3.6	4.3	4.7
Max. Radial Loading [N]	78	78	245	245	245	245	392	392	490	490
Max. Axial Loading [N]	54	54	74	74	74	74	147	147	98	98
Brake Holding Torque [N·m (min)]Note 2	n/a	0.32	n/a	1.3	n/a	1.3	n/a	2.5	n/a	8
Brake Power Consumption (at 20°C) [W]	n/a	6.1	n/a	7.2	n/a	7.2	n/a	8	n/a	18.7
Brake Release Time [ms (max)]	n/a	20	n/a	20	n/a	20	n/a	20	n/a	10
Brake Pull-in Time [ms (max)]	n/a	35	n/a	50	n/a	50	n/a	60	n/a	70
Vibration Grade [μm]	V15									
Operating Temperature [°C]	0–40 °C (32–104 °F)									
Storage Temperature [°C]	-10°C to 80°C (-14°F to 176°F)									
Operating Humidity	20–90% relative humidity (non-condensing)									
Storage Humidity	20–90% relative humidity (non-condensing)									
Vibration Capacity	2.5 G									
IP Rating ³	IP67 (when using waterproof connectors)								IP65 (when using waterproof connectors)	
Encoder Resolution	24-bit (16777216 p/rev)									
Agency Approvals	cUR _{US} , CE									

Note 1—The rated torque is the continuous permissible torque between the 0°C and 40°C operating temperature which is suitable for a servo motor mounted with the following heat sink dimensions: 250mm x 250mm x 6mm made from aluminum (or mounted to equipment with an equivalent heat sinking capability).

Note 2—The built-in servo motor brake is only for holding the load in a stopped state. Do not use for deceleration or as a dynamic brake.

Note 3—All SureServo2 motors are shipped with oil seals installed for IP rating requirements.



AC Servo Motor Specifications

230V Medium Inertia Motor Specifications

230V SureServo2 Medium Inertia Motor Specifications								
Model	SV2M-210N	SV2M-210B	SV2M-215N	SV2M-215B	SV2M-220N	SV2M-220B	SV2M-230N	SV2M-230B
Price	\$497.00	\$711.00	\$537.00	\$795.00	\$651.00	\$863.00	\$735.00	\$947.00
Drawing	PDF	PDF	PDF	PDF	PDF	PDF	PDF	PDF
Rated Power [kW]	1.0	1.0	1.5	1.5	2.0	2.0	3.0	3.0
Rated Torque [N·m]Note 1	4.77	4.77	7.16	7.16	9.55	9.55	17.55	17.55
Max. Torque [N·m]	14.32	14.32	14.88	14.88	24.54	24.54	48.29	48.29
Rated Speed [rpm]	2000						1700	
Max. Speed [rpm]	3000							
Rated current [Amps] rms	5.66	5.66	8.33	8.33	12.1	12.1	17.9	17.9
Max. Instantaneous Current [Amps] rms	19.73	19.73	20.16	20.16	33.66	33.66	55.93	55.93
Change of Rated Power [W/s]	27.1	24.90	45.8	43.10	26.3	24.10	56.0	53.90
Rotor Inertia [x10 ⁻⁴ kg m ²]	8.41	9.14	11.2	11.9	34.7	37.8	55	57.1
Mechanical Time Constant [ms]	1.54	1.67	1.12	1.18	1.75	1.90	1.29	1.34
Torque Constant-KT [N·m/A]	0.843	0.843	0.860	0.860	0.789	0.789	0.980	0.980
Voltage Constant-KE [mV/rpm]	31.9	31.9	31.8	31.8	31.4	31.4	35	35
Armature Resistance [Ohm]	0.47	0.47	0.26	0.26	0.119	0.119	0.077	0.077
Armature Inductance [mH]	5.99	5.99	4.01	4.01	2.84	2.84	1.27	1.27
Electrical Time Constant [ms]	12.74	12.74	15.42	15.42	23.87	23.87	16.49	16.49
Insulation Class	Class A (UL), Class B (CE)							
Insulation Resistance	> 100MΩ, 500VDC							
Insulation Strength	1.8 kVAC, 1 second							
Weight [kg]	7.0	8.4	7.5	8.9	13.5	17.5	18.5	22.5
Max. Radial Loading [N]	490				1176		1470	
Max. Axial Loading [N]	98				490			
Brake Holding Torque [N·m (min)]Note 2	n/a	10	n/a	10	n/a	25	n/a	25
Brake Power Consumption (at 20°C) [W]		19		19		20.4		20.4
Brake Release Time [ms (max)]		10		10		10		10
Brake Pull-in Time [ms (max)]		70		70		70		70
Vibration Grade [μm]	V15							
Operating Temperature [°C]	0–40 °C (32–104 °F)							
Storage Temperature [°C]	-10°C to 80°C (-14°F to 176°F)							
Operating Humidity	20–90% relative humidity (non-condensing)							
Storage Humidity	20–90% relative humidity (non-condensing)							
Vibration Capacity	2.5 G							
IP Rating ³	IP65 (when using waterproof connectors)							
Encoder Resolution	24-bit (16777216 p/rev)							
Agency Approvals	cUR _{US} , CE							

Note 1—The rated torque is the continuous permissible torque between the 0°C and 40°C operating temperature which is suitable for a servo motor mounted with the following heat sink dimensions: 250mm x 250mm x 6mm made from aluminum (or mounted to equipment with an equivalent heat sinking capability).

Note 2—The built-in servo motor brake is only for holding the load in a stopped state. Do not use for deceleration or as a dynamic brake.

Note 3—All SureServo2 motors are shipped with oil seals installed for IP rating requirements.



AC Servo Motor Specifications

230V High Inertia Motor Specifications

230V SureServo2 High Inertia Motor Specifications										
Model	SV2H-245N	SV2H-245B	SV2H-255N	SV2H-255B	SV2H-275N	SV2H-275B	SV2H-2B0N	SV2H-2B0B	SV2H-2F0N	SV2H-2F0B
Price	\$911.00	\$1,415.00	\$1,050.00	\$1,568.00	\$1,273.00	\$1,989.00	\$1,956.00	\$2,682.00	\$2,257.00	\$3,091.00
Drawing	PDF	PDF	PDF	PDF	PDF	PDF	PDF	PDF	PDF	PDF
Rated Power [kW]	4.5	4.5	5.5	5.5	7.5	7.5	11	11	15	15
Rated Torque [N·m]Note 1	28.65	28.65	35.01	35.01	47.74	47.74	70	70	95.4	95.4
Max. Torque [N·m]	71.62	71.62	87.53	87.53	119.36	119.36	175	175	224.0	224.0
Rated Speed [rpm]	1500									
Max. Speed [rpm]	3000					2000				
Rated current [Amps] rms	32.5	32.5	40.12	40.12	47.5	47.5	51.1	51.1	67	67
Max. Instantaneous Current [Amps] rms	91.4	91.4	108.0	108.0	127.46	127.46	129.5	129.5	162	162
Change of Rated Power [W/s]	105.6	101.8	122.8	119.3	159.7	156.6	145.0	141.4	201.8	197.1
Rotor Inertia [x10 ⁻⁴ kg m ²]	77.75	80.65	99.78	102.70	142.7	145.55	338	346.5	451	461.8
Mechanical Time Constant [ms]	0.93	0.96	0.97	0.99	0.84	0.85	1.38	1.41	1.22	1.25
Torque Constant-KT [N·m/A]	0.878	0.878	0.873	0.873	1.005	1.005	1.370	1.370	1.424	1.424
Voltage Constant-KE [mV/rpm]	32.0	32.0	31.0	31.0	35.5	35.5	49	49	50	50
Armature Resistance [Ohm]	0.032	0.032	0.025	0.025	0.02	0.02	0.0261	0.0261	0.0184	0.0184
Armature Inductance [mH]	0.89	0.89	0.71	0.71	0.6	0.6	0.65	0.65	0.48	0.48
Electrical Time Constant [ms]	27.81	27.81	28.4	28.4	30.0	30.0	24.9	24.9	26.09	26.09
Insulation Class	Class A (UL), Class B (CE)						Class F (UL), Class F (CE)			
Insulation Resistance	> 100MΩ, 500VDC									
Insulation Strength	1.8 kVAC, 1 second									
Weight [kg]	23.5	29	30.5	36	40.5	46	56.4	68.4	75	87
Max. Radial Loading [N]	1470			1764			3300			
Max. Axial Loading [N]	490			588			1100			
Brake Holding Torque [N·m (min)]Note 2		55.0		55.0		55.0		115		115
Brake Power Consumption (at 20°C) [W]		19.9		19.9		19.9		28.8		28.8
Brake Release Time [ms (max)]	n/a	10	n/a	10	n/a	10	n/a	10	n/a	10
Brake Pull-in Time [ms (max)]		70		70		70		70		70
Vibration Grade [μm]	V15									
Operating Temperature [°C]	0–40 °C (32–104 °F)									
Storage Temperature [°C]	-10°C to 80°C (-14°F to 176°F)									
Operating Humidity	20–90% relative humidity (non-condensing)									
Storage Humidity	20–90% relative humidity (non-condensing)									
Vibration Capacity	2.5 G									
IP Rating ³	IP65 (when using specified cables)									
Encoder Resolution	24-bit (16777216 p/rev)									
Agency Approvals	cURUS, CE									

Note 1—The rated torque is the continuous permissible torque between the 0°C and 40°C operating temperature which is suitable for a servo motor mounted with the following heat sink dimensions:

300mm x 300mm x 12mm, 400mm x 400mm x 20mm, 550mm x 550mm x 30mm

All made from aluminum (or mounted to equipment with an equivalent heat sinking capability)

Note 2—The built-in servo motor brake is only for holding the load in a stopped state. Do not use it for deceleration or as a dynamic brake.

Note 3—All SureServo2 motors are shipped with oil seals installed for IP rating requirements.



AC Servo Motor Specifications

460V Low Inertia Motor Specifications

460V SureServo2 Low Inertia Motor Specifications										
Model	SV2L-404N	SV2L-404B	SV2L-407N	SV2L-407B	SV2L-410N	SV2L-410B	SV2L-415N	SV2L-415B	SV2L-420N	SV2L-420B
Price	\$360.00	\$515.00	\$388.00	\$555.00	\$505.00	\$745.00	\$580.00	\$855.00	\$687.00	\$899.00
Drawing	PDF	PDF	PDF	PDF	PDF	PDF	PDF	PDF	PDF	PDF
Rated Power [kW]	0.4	0.4	0.75	0.75	1.0	1.0	1.5	1.5	2.0	2.0
Rated Torque [N·m]Note 1	1.27	1.27	2.24	2.24	3.18	3.18	7.16	7.16	9.55	9.55
Max. Torque [N·m]	4.45	4.45	7.58	7.58	9.54	9.54	18.1	18.1	28.65	28.65
Rated Speed [rpm]	3000		3200		3000		2000			
Max. Speed [rpm]	6000		6000		5000		3000			
Rated current [Amps] rms	1.43	1.43	2.90	2.90	4.36	4.36	5.1	5.1	6.7	6.7
Max. Instantaneous Current [Amps] rms	5.25	5.25	9.70	9.70	13.74	13.74	13.28	13.28	21.35	21.35
Change of Rated Power [W/s]	35.8	33.6	33.2	30.2	38.2	30.40	45.9	43.10	62.5	57.4
Rotor Inertia [x10 ⁻⁴ kg m ²]	0.45	0.48	1.51	1.66	2.65	3.33	11.18	11.9	14.59	15.88
Mechanical Time Constant [ms]	1.05	1.12	1.02	1.12	0.81	1.02	1.26	1.34	1.11	1.21
Torque Constant-KT [N·m/A]	0.888	0.888	0.772	0.772	0.729	0.729	1.404	1.404	1.425	1.425
Voltage Constant-KE [mV/rpm]	31.83	31.83	27.83	27.83	29.00	29.00	55.00	55.00	55.00	55.00
Armature Resistance [Ohm]	6.28	6.28	1.38	1.38	0.617	0.617	0.83	0.83	0.57	0.57
Armature Inductance [mH]	13.34	13.34	4.78	4.78	6.03	6.03	11.67	11.67	8.29	8.29
Electrical Time Constant [ms]	2.12	2.12	3.46	3.46	9.77	9.77	14.06	14.06	14.54	14.54
Insulation Class	Class A (UL), Class B (CE)									
Insulation Resistance	> 100 MΩ, 500VDC									
Insulation Strength	2.3 kVAC, 1 sec									
Weight [kg]	1.4	1.9	2.8	3.6	4.3	4.7	7.5	8.9	7.8	9.2
Max. Radial Loading [N]	245	245	392	392	490	490	490	490	490	490
Max. Axial Loading [N]	74	74	147	147	98	98	98	98	98	98
Brake Holding Torque [N·m (min)]Note 2	n/a	1.3	n/a	2.5	n/a	8	n/a	10	n/a	10
Brake Power Consumption (at 20°C) [W]		7.2		8		18.7		19		19
Brake Release Time [ms (max)]		20		20		10		10		10
Brake Pull-in Time [ms (max)]		50		60		70		70		70
Vibration Grade [μm]	V15									
Operating Temperature [°C]	0–40 °C (32–104 °F)									
Storage Temperature [°C]	-10°C to 80°C (-14°F to 176°F)									
Operating Humidity	20–90% relative humidity (non-condensing)									
Storage Humidity	20–90% relative humidity (non-condensing)									
Vibration Capacity	2.5 G									
IP Rating	IP67 (when using waterproof connectors and when an oil seal is fitted to the rotating shaft (for an oil seal model))				IP65 (when using waterproof connectors and when an oil seal is fitted to the rotating shaft (for an oil seal model))					
Encoder Resolution	24-bit (16777216 p/rev)									
Agency Approvals	cUR _{US} , CE									

Note 1—The rated torque is the continuous permissible torque between the 0°C and 40°C operating temperature which is suitable for a servo motor mounted with the following heat sink dimensions: 250mm x 250mm x 6mm made from aluminum (or mounted to equipment with an equivalent heat sinking capability).

Note 2—The built-in servo motor brake is only for holding the load in a stopped state. Do not use for deceleration or as a dynamic brake.



AC Servo Motor Specifications

460V Medium Inertia Motor Specifications

460V SureServo2 Medium Inertia Motor Specifications		
Model	SV2M-410N	SV2M-410B
Price	\$530.00	\$765.00
Drawing	PDF	PDF
Rated Power [kW]	1.0	1.0
Rated Torque [N·m]Note 1	4.77	4.77
Max. Torque [N·m]	14.32	14.32
Rated Speed [rpm]	2000	
Max. Speed [rpm]	3000	
Rated current [Amps] rms	3.6	3.6
Max. Instantaneous Current [Amps] rms	11.41	11.41
Change of Rated Power [W/s]	27.1	24.90
Rotor Inertia [x10 ⁻⁴ kg m ²]	8.41	9.14
Mechanical Time Constant [ms]	1.85	2.01
Torque Constant-KT [N·m/A]	1.325	1.325
Voltage Constant-KE [mV/rpm]	53.20	53.20
Armature Resistance [Ohm]	1.477	1.477
Armature Inductance [mH]	17.79	17.79
Electrical Time Constant [ms]	12.04	12.04
Insulation Class	Class A (UL), Class B (CE)	
Insulation Resistance	> 100 MΩ, 500VDC	
Insulation Strength	2.3 kVAC, 1 sec	
Weight [kg]	7.0	8.4
Max. Radial Loading [N]	490	
Max. Axial Loading [N]	98	
Brake Holding Torque [N·m (min)]Note 2		10
Brake Power Consumption (at 20°C) [W]	n/a	19
Brake Release Time [ms (max)]		10
Brake Pull-in Time [ms (max)]		70
Vibration Grade [μm]	V15	
Operating Temperature [°C]	0–40 °C (32–104 °F)	
Storage Temperature [°C]	-10°C to 80°C (-14°F to 176°F)	
Operating Humidity	20–90% relative humidity (non-condensing)	
Storage Humidity	20–90% relative humidity (non-condensing)	
Vibration Capacity	2.5 G	
IP Rating	IP65 (when using waterproof connectors and when an oil seal is fitted to the rotating shaft (for an oil seal model))	
Encoder Resolution	24-bit (16777216 p/rev)	
Agency Approvals	cUR _{US} , CE	

Note 1—The rated torque is the continuous permissible torque between the 0°C and 40°C operating temperature which is suitable for a servo motor mounted with the following heat sink dimensions: 250mm x 250mm x 6mm made from aluminum (or mounted to equipment with an equivalent heat sinking capability).

Note 2—The built-in servo motor brake is only for holding the load in a stopped state. Do not use for deceleration or as a dynamic brake.



AC Servo Motor Specifications

460V High Inertia Motor Specifications

460V SureServo2 High Inertia Motor Specifications						
Model	SV2H-430N	SV2H-430B	SV2H-445N	SV2H-445B	SV2H-455N	SV2H-455B
Price	\$823.00	\$1,001.00	\$939.00	\$1,456.00	\$1,082.00	\$1,614.00
Drawing	PDF	PDF	PDF	PDF	PDF	PDF
Rated Power [kW]	3.0	3.0	4.5	4.5	5.5	5.5
Rated Torque [N·m]Note 1	19.1	19.1	28.65	28.65	35	35
Max. Torque [N·m]	49.38	49.38	64.61	64.61	73.48	73.48
Rated Speed [rpm]	1500					
Max. Speed [rpm]	3000					
Rated current [Amps] rms	12.2	12.2	21.9	21.9	23.6	23.6
Max. Instantaneous Current [Amps] rms	30.46	30.46	47.5	47.5	47.5	47.5
Change of Rated Power [W/s]	66.4	63.9	105.6	101.8	122.8	119.3
Rotor Inertia [x10 ⁻⁴ kg m ²]	54.95	57.1	77.75	80.65	99.78	80.65
Mechanical Time Constant [ms]	1.20	1.24	1.06	1.10	0.84	0.86
Torque Constant-KT [N·m/A]	1.566	1.566	1.308	1.308	1.483	1.483
Voltage Constant-KE [mV/rpm]	64.4	64.4	53.00	53.00	58.9	58.9
Armature Resistance [Ohm]	0.21	0.21	0.09	0.09	0.07	0.07
Armature Inductance [mH]	4.94	4.94	2.36	2.36	2.20	2.20
Electrical Time Constant [ms]	23.52	23.52	26.22	26.22	31.43	31.43
Insulation Class	Class A (UL), Class B (CE)					
Insulation Resistance	> 100 MΩ, 500VDC					
Insulation Strength	2.3 kVAC, 1 sec					
Weight [kg]	18.5	22.5	23.5	29	30.5	36
Max. Radial Loading [N]	1470				1764	
Max. Axial Loading [N]	490				588	
Brake Holding Torque [N·m (min)]Note 2	25		55		55	
Brake Power Consumption (at 20°C) [W]	20.4		19.9		19.9	
Brake Release Time [ms (max)]	10		10		10	
Brake Pull-in Time [ms (max)]	70		70		70	
Vibration Grade [μm]	V15					
Operating Temperature [°C]	0–40 °C (32–104 °F)					
Storage Temperature [°C]	-10°C to 80°C (-14°F to 176°F)					
Operating Humidity	20–90% relative humidity (non-condensing)					
Storage Humidity	20–90% relative humidity (non-condensing)					
Vibration Capacity	2.5 G					
IP Rating	IP65 (when using waterproof connectors and when an oil seal is fitted to the rotating shaft (for an oil seal model))					
Encoder Resolution	24-bit (16777216 p/rev)					
Agency Approvals	cUR _{US} , CE					

Continued on next page

Note 1–The rated torque is the continuous permissible torque between the 0°C and 40°C operating temperature which is suitable for a servo motor mounted with the following heat sink dimensions:

300mm x 300mm x 12mm

400mm x 400mm x 20mm

550mm x 550mm x 30mm

All made from aluminum (or mounted to equipment with an equivalent heat sinking capability)

Note 2–The built-in servo motor brake is only for holding the load in a stopped state. Do not use it for deceleration or as a dynamic brake.



AC Servo Motor Specifications

460V High Inertia Motor Specifications, *continued*

460V SureServo2 High Inertia Motor Specifications						
Model	SV2H-475N	SV2H-475B	SV2H-4B0N	SV2H-4B0B	SV2H-4F0N	SV2H-4F0B
Price	\$1,311.00	\$2,047.00	\$2,014.00	\$2,760.00	\$2,324.00	\$3,182.00
Drawing	PDF	PDF	PDF	PDF	PDF	PDF
Rated Power [kW]	7.5	7.5	11	11	15	15
Rated Torque [N·m]Note 1	47.74	47.74	70	70	95.4	95.4
Max. Torque [N·m]	93.71	93.71	175	175	224.0	224.0
Rated Speed [rpm]	1500		1500			
Max. Speed [rpm]	3000		2000			
Rated current [Amps] rms	28.7	28.7	26.8	26.8	37.5	37.5
Max. Instantaneous Current [Amps] rms	57.69	57.69	67.7	67.7	95.3	95.3
Change of Rated Power [W/s]	159.7	156.6	145.0	141.4	201.8	197.1
Rotor Inertia [x10 ⁻⁴ kg m ²]	142.7	145.5	338	346.5	451	461.8
Mechanical Time Constant [ms]	0.81	0.83	1.40	1.44	1.21	1.23
Torque Constant-KT [N·m/A]	1.663	1.663	2.612	2.612	2.544	2.544
Voltage Constant-KE [mV/rpm]	66.40	66.40	96.00	96.00	83.90	83.90
Armature Resistance [Ohm]	0.06	0.06	0.0994	0.0994	0.0545	0.0545
Armature Inductance [mH]	1.70	1.70	2.51	2.51	1.43	1.43
Electrical Time Constant [ms]	28.33	28.33	25.25	25.25	26.24	26.24
Insulation Class	Class A (UL), Class B (CE)		Class F (UL), Class F (CE)			
Insulation Resistance	> 100 MΩ, 500VDC					
Insulation Strength	2.3 kVAC, 1 sec					
Weight [kg]	40.5	46	56.4	68.4	75	87
Max. Radial Loading [N]	1764		3300			
Max. Axial Loading [N]	588		1100			
Brake Holding Torque [N·m (min)]Note 2	n/a	55	n/a	115	n/a	115
Brake Power Consumption (at 20°C) [W]		19.9		28.8		28.8
Brake Release Time [ms (max)]		10		10		10
Brake Pull-in Time [ms (max)]		70		70		70
Vibration Grade [μm]	V15					
Operating Temperature [°C]	0–40 °C (32–104 °F)					
Storage Temperature [°C]	-10°C to 80°C (-14°F to 176°F)					
Operating Humidity	20–90% relative humidity (non-condensing)					
Storage Humidity	20–90% relative humidity (non-condensing)					
Vibration Capacity	2.5 G					
IP Rating	IP65 (when using waterproof connectors and when an oil seal is fitted to the rotating shaft (for an oil seal model))					
Encoder Resolution	24-bit (16777216 p/rev)					
Agency Approvals	cUR _{US} , CE					

Note 1–The rated torque is the continuous permissible torque between the 0°C and 40°C operating temperature which is suitable for a servo motor mounted with the following heat sink dimensions:

300mm x 300mm x 12mm

400mm x 400mm x 20mm

550mm x 550mm x 30mm

All made from aluminum (or mounted to equipment with an equivalent heat sinking capability)

Note 2–The built-in servo motor brake is only for holding the load in a stopped state. Do not use it for deceleration or as a dynamic brake.



AC Servo System Dimensions

230V Servo motor dimensions

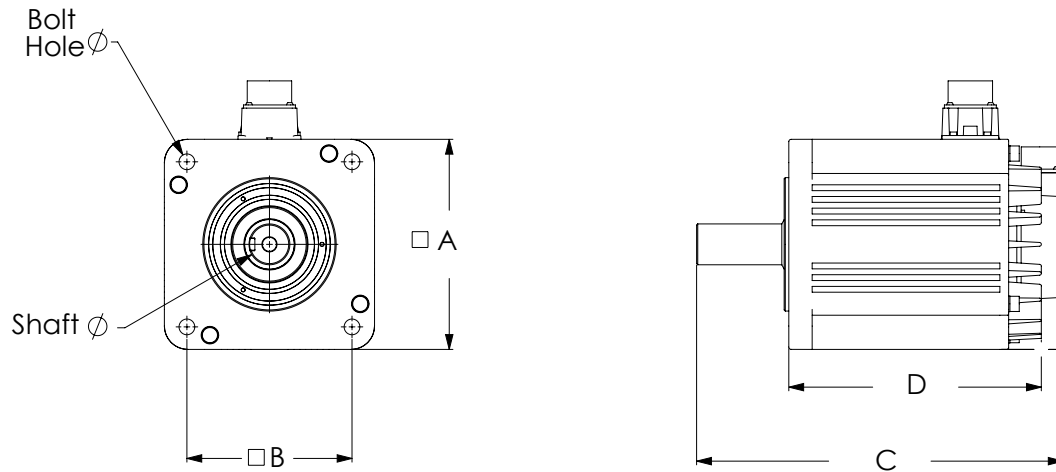

SureServo2 230V Motor Dimensions							
Model	Drawing Link	A mm [inches]	B mm [inches]	C mm [inches]	D mm [inches]	Bolt Hole Ø mm [inches]	Shaft Ø mm [inches]
SV2L-201N	PDF	40.0 [1.57]	32.2 [1.27]	110.3 [4.34]	85.3 [3.36]	4.5 [0.18]	8.0 [0.31]
SV2L-201B	PDF	40.0 [1.57]	32.2 [1.27]	145.1 [5.71]	120.1 [4.73]	4.5 [0.18]	8.0 [0.31]
SV2L-202N	PDF	60.0 [2.36]	49.5 [1.95]	113.9 [4.49]	84.0 [3.31]	5.5 [0.22]	14.0 [0.55]
SV2L-202B	PDF	60.0 [2.36]	49.5 [1.95]	147.6 [5.81]	117.1 [4.61]	5.5 [0.22]	14.0 [0.55]
SV2L-204N	PDF	60.0 [2.36]	49.5 [1.95]	136.0 [5.35]	106.0 [4.17]	5.5 [0.22]	14.0 [0.55]
SV2L-204B	PDF	60.0 [2.36]	49.5 [1.95]	169.7 [6.68]	139.7 [5.50]	5.5 [0.22]	14.0 [0.55]
SV2L-207N	PDF	80.0 [3.15]	63.6 [2.51]	155.8 [6.13]	115.8 [4.56]	6.6 [2.51]	19.0 [0.75]
SV2L-207B	PDF	80.0 [3.15]	63.6 [2.51]	193.2 [7.61]	153.2 [6.03]	6.6 [2.51]	19.0 [0.75]
SV2L-210N	PDF	100.0 [3.94]	81.3 [3.20]	198.3 [7.81]	110.2 [4.34]	9.0 [0.35]	22.0 [0.87]
SV2L-210B	PDF	100.0 [3.94]	81.3 [3.20]	237.5 [9.35]	149.5 [5.89]	9.0 [0.35]	22.0 [0.87]
SV2M-210N	PDF	130.0 [5.12]	102.5 [4.04]	202.5 [7.97]	104.5 [4.11]	9.0 [0.35]	22.0 [0.87]
SV2M-210B	PDF	130.0 [5.12]	102.5 [4.04]	238.5 [9.39]	140.5 [5.53]	9.0 [0.35]	22.0 [0.87]
SV2M-215N	PDF	130.0 [5.12]	102.5 [4.04]	222.5 [8.76]	120.5 [4.74]	9.0 [0.35]	22.0 [0.87]
SV2M-215B	PDF	130.0 [5.12]	102.5 [4.04]	257.0 [10.12]	155.0 [6.10]	9.0 [0.35]	22.0 [0.87]
SV2M-220N	PDF	180.0 [7.09]	141.4 [5.57]	247.7 [9.75]	150.0 [5.91]	13.5 [0.53]	35.0 [1.38]
SV2M-220B	PDF	180.0 [7.09]	141.4 [5.57]	281.8 [11.09]	184.1 [7.25]	13.5 [0.53]	35.0 [1.38]
SV2M-230N	PDF	180.0 [7.09]	141.4 [5.57]	280.8 [11.06]	183.1 [7.21]	13.5 [0.53]	35.0 [1.38]
SV2M-230B	PDF	180.0 [7.09]	141.4 [5.57]	314.0 [12.36]	216.3 [8.52]	13.5 [0.53]	35.0 [1.38]
SV2H-245N	PDF	180.0 [7.09]	141.4 [5.57]	314.0 [12.36]	216.3 [8.52]	13.5 [0.53]	35.0 [1.38]
SV2H-245B	PDF	180.0 [7.09]	141.4 [5.57]	358.0 [14.09]	260.3 [10.25]	13.5 [0.53]	35.0 [1.38]
SV2H-255N	PDF	180.0 [7.09]	141.4 [5.57]	392.4 [15.45]	260.7 [10.26]	13.5 [0.53]	42.0 [1.63]
SV2H-255B	PDF	180.0 [7.09]	141.4 [5.57]	424.4 [16.71]	292.7 [11.52]	13.5 [0.53]	42.0 [1.63]
SV2H-275N	PDF	180.0 [7.09]	141.4 [5.57]	454.7 [17.9]	323.0 [12.72]	13.5 [0.53]	42.0 [1.63]
SV2H-275B	PDF	180.0 [7.09]	141.4 [5.57]	488.8 [19.24]	357.1 [14.06]	13.5 [0.53]	42.0 [1.63]
SV2H-2B0N	PDF	219.9 [8.66]	166.2 [6.54]	487.4 [19.19]	319.0 [12.56]	13.5 [0.53]	42.0 [1.63]
SV2H-2B0B	PDF	219.9 [8.66]	166.2 [6.54]	550.4 [21.67]	382.0 [15.04]	13.5 [0.53]	42.0 [1.63]
SV2H-2F0N	PDF	219.9 [8.66]	166.2 [6.54]	566.4 [22.30]	398.0 [15.67]	13.5 [0.53]	55.0 [2.17]
SV2H-2F0B	PDF	219.9 [8.66]	166.2 [6.54]	629.4 [24.78]	461.0 [18.15]	13.5 [0.53]	55.0 [2.17]



NOTE: Motor cables are approximately 304mm (12") in length.



For additional dimensions, see the AutomationDirect website or click on the drawing links.

460V Servo motor dimensions

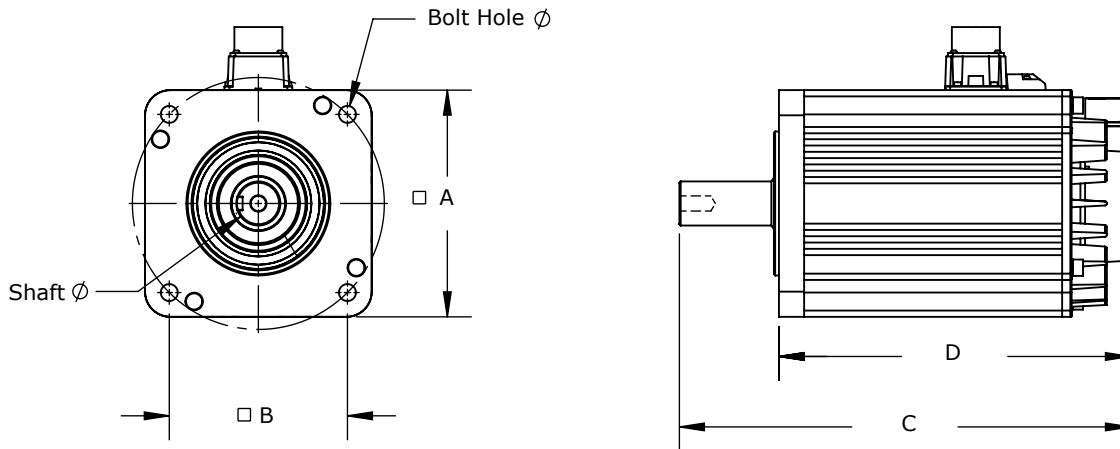

SureServo2 460V Motor Dimensions

Model	Drawing Link	A mm [inches]	B mm [inches]	C mm [inches]	D mm [inches]	Bolt Hole Ø mm [inches]	Shaft Ø mm [inches]
SV2L-404N	PDF	60.0 [2.36]	49.5 [1.95]	136.0 [5.35]	106.0 [4.17]	5.5 [0.22]	14.0 [0.55]
SV2L-404B	PDF	60.0 [2.36]	49.5 [1.95]	169.7 [6.68]	139.7 [5.50]	5.5 [0.22]	14.0 [0.55]
SV2L-407N	PDF	80.0 [3.15]	63.6 [2.51]	155.8 [6.13]	115.8 [4.56]	6.6 [0.26]	19.0 [0.75]
SV2L-407B	PDF	80.0 [3.15]	63.6 [2.51]	193.2 [7.61]	153.2 [6.03]	6.6 [0.26]	19.0 [0.75]
SV2L-410N	PDF	100.0 [3.94]	81.3 [3.20]	198.2 [7.81]	153.2 [6.03]	9.0 [0.35]	22.0 [0.87]
SV2L-410B	PDF	100.0 [3.94]	81.3 [3.20]	237.5 [9.35]	192.5 [7.58]	9.0 [0.35]	22.0 [0.87]
SV2L-415N	PDF	130.0 [5.12]	102.5 [4.04]	222.5 [8.76]	167.5 [6.59]	9.0 [0.35]	22.0 [0.87]
SV2L-415B	PDF	130.0 [5.12]	102.5 [4.04]	257.0 [10.12]	202.0 [7.95]	9.0 [0.35]	22.0 [0.87]
SV2L-420N	PDF	130.0 [5.12]	102.5 [4.04]	242.5 [9.55]	187.5 [7.38]	9.0 [0.35]	22.0 [0.87]
SV2L-420B	PDF	130.0 [5.12]	102.5 [4.04]	271.0 [10.67]	216.0 [8.50]	9.0 [0.35]	22.0 [0.87]
SV2M-410N	PDF	130.0 [5.12]	102.5 [4.04]	202.5 [7.97]	147.5 [5.81]	9.0 [0.35]	22.0 [0.87]
SV2M-410B	PDF	130.0 [5.12]	102.5 [4.04]	238.5 [9.39]	183.5 [7.22]	9.0 [0.35]	22.0 [0.87]
SV2H-430N	PDF	180.0 [7.09]	141.4 [5.57]	280.8 [11.06]	201.8 [7.94]	13.5 [0.53]	35.0 [1.38]
SV2H-430B	PDF	180.0 [7.09]	141.4 [5.57]	314.0 [12.36]	235.0 [9.25]	13.5 [0.53]	35.0 [1.38]
SV2H-445N	PDF	180.0 [7.09]	141.4 [5.57]	314.0 [12.36]	235.0 [9.25]	13.5 [0.53]	35.0 [1.38]
SV2H-445B	PDF	180.0 [7.09]	141.4 [5.57]	358.0 [14.09]	279.0 [10.98]	13.5 [0.53]	35.0 [1.38]
SV2H-455N	PDF	180.0 [7.09]	141.4 [5.57]	392.4 [15.45]	279.4 [11.00]	13.5 [0.53]	42.0 [1.65]
SV2H-455B	PDF	180.0 [7.09]	141.4 [5.57]	424.4 [16.71]	311.4 [12.26]	13.5 [0.53]	42.0 [1.65]
SV2H-475N	PDF	180.0 [7.09]	141.4 [5.57]	454.7 [17.90]	341.7 [13.45]	13.5 [0.53]	42.0 [1.65]
SV2H-475B	PDF	180.0 [7.09]	141.4 [5.57]	488.8 [19.24]	375.8 [14.80]	13.5 [0.53]	42.0 [1.65]
SV2H-4B0N	PDF	220.0 [8.66]	166.2 [6.54]	487.4 [19.19]	371.4 [14.62]	13.5 [0.53]	42.0 [1.65]
SV2H-4B0B	PDF	220.0 [8.66]	166.2 [6.54]	550.4 [21.67]	434.4 [17.10]	13.5 [0.53]	42.0 [1.65]
SV2H-4F0N	PDF	220.0 [8.66]	166.2 [6.54]	566.4 [22.30]	450.4 [17.73]	13.5 [0.53]	55.0 [2.17]
SV2H-4F0B	PDF	220.0 [8.66]	166.2 [6.54]	629.4 [24.78]	513.4 [20.21]	13.5 [0.53]	55.0 [2.17]



NOTE: Motor cables are approximately 304mm (12") in length.



For additional dimensions, see the AutomationDirect website or click on the drawing links.