

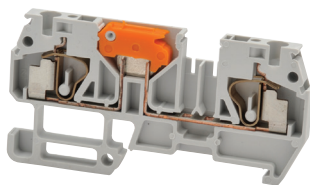

Screwless Knife-Blade Disconnect Terminal Blocks

The DN-QKBD12-A allows fast circuit disconnection without rewiring and is 35mm DIN-rail mountable. This model provides circuit disconnection capability by means of a pivoting, insulated "knife blade."



DN-QKBD12-A (Euro QT2.5/35)

Dimensions

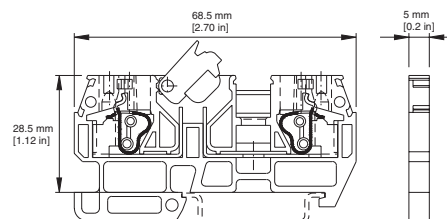

WARNING: DO NOT DISCONNECT UNDER LOAD

Knife - Blade Disconnect Screwless Terminal Block				
		Part Number	Qty	Price
Gray Terminal Block		DN-QKBD12-A	25	\$72.00
Description		Knife-blade disconnect screwless terminal block for 24-12 AWG wire		
Specifications				
Wire Strip Length		12mm [0.47 in]		
Density		200/m [60 pcs/ft]		
UL Approval*		600V	20A	24-12 AWG
VDE Approval		630V	24A	2.5 mm ²
Operating Temperature		Ambient air temperature: -20 to 85°C [-4 to 185°F] Relative humidity: 50% max at 40°C [104°F]; 90% max at 20°C [68°F]		
SCCR		10kA per Table SB4.1, 2009, UL 508A, Maximum short circuit current rating for unmarked components		
CE Conformity		CE (EN 60947-1 / EN 60947-7-1)		
Agency File #		UL E179129		
Accessories				
		Part Number	Pcs/ Pkg	Price
End Cover		DN-QEC12-1-2	25	\$15.00
Jumpers	2-pole	DN-2J2Y	100	\$43.00
		DN-2J2YMN	25	\$13.00
	3-pole	DN-3J2Y	100	\$62.00
DN-3J2YMN		25	\$18.00	
	24-pole	DN-24J2Y	5	\$28.00
Jumper Cutting Tool		DN-J2CUT	1	\$79.00
35mm DIN Rail	7.5 mm high	DN-R35S1	10	\$39.00
		DN-R35S1-2	2	\$11.00
End Brackets		DN-EB35	50	\$67.00
		DN-EB35MN	20	\$31.50
		DN-EB35-A	50	\$47.50
		DN-EB35-A-10	10	\$12.00
		DN-QEB35	50	\$42.50
		DN-QEB35-10	10	\$11.50
Angled Support Bracket		DN-ASB1	50	\$107.00
Marking Tags		DN-QL Series	500	various

* Copper wire only.

For more information on accessories, see the DINnectors Accessories section of this chapter.

Screwless Terminal Blocks Overview

Why go screwless?

Screwless clamping technology offers several benefits:

- **Speed:** On average, screwless connections can be made in half the time of screw type connections, cutting installation labor costs in half.
- **Ease:** No need for twisting and turning screws, so screwless terminal blocks are much easier on the installer's hands and arms. Also, wiring from the top of the terminal blocks allow installers to accurately and reliably see the wire fully inserted into the spring clamp.
- **Safety:** Never have a problem with faulty connections from loose screws again! Meets the same UL, and IEC standards as screw-type terminal blocks.
- **Maintenance-free:** The screwless spring clamp conforms to the wire with constant tension, making it maintenance-free.

Are there any trade-offs of going screwless versus screw-type?

Unless you need to clamp multiple wires to the same connection point, the answer is no. If you do, then there may be a slight trade-off in requiring more panel space than with screw terminal blocks. Unlike screw terminal blocks, screwless terminal block spring-clamps are designed to clamp a single wire, only. This is why multiple versions exist like the "one-to-two" or "two-to-two." These versions allow multiple wires to be connected together via multiple spring clamps.

How does it work?

Well, it's pretty simple: Push, Insert, Release. Just push your screwdriver into the spring clamp (a rectangular shaped hole) to open the spring clamp (a circular shaped hole), insert the stripped wire into the clamp (a circular shaped hole), and pull out your screwdriver to release the clamp against the wire. That's it. The connection is made.

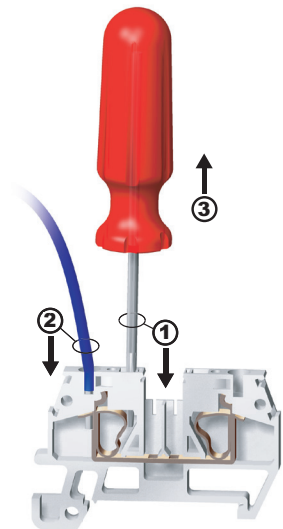

How do the jumpers work?

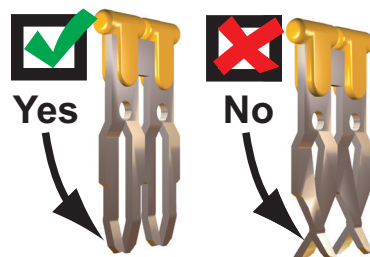
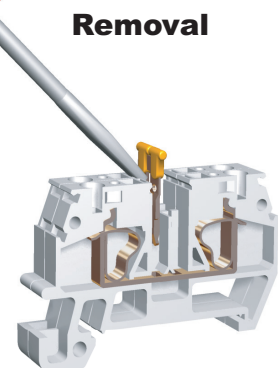
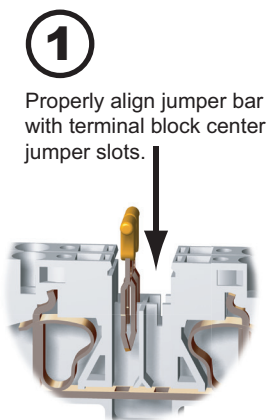

Yes = Good, acceptable jumper
No = Bad, damaged jumper

DINnectors Accessories

Steel DIN Rails Features

35mm wide

- Available in 1-meter lengths
- 7.5 mm-high rails primarily used to mount terminal blocks, relays, timers and small PLCs such as the BRX, CLICK, DirectLogic and Productivity series. 15mm-high rails for mounting larger and heavier components such as contactors and larger PLCs

15mm wide

- Available in 1-meter lengths
- DN-R15S1 exclusively for mounting mini terminal blocks such as the DN-M10-A

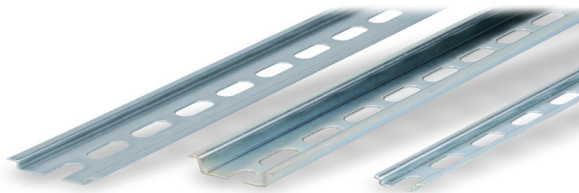

Steel DIN Rails Specifications									
	Part Number	Qty	Price	Part Number	Qty	Price	Part Number	Qty	Price
DIN Rail	<u>DN-R35S1</u>	10	\$39.00	<u>DN-R35HS1</u>	10	\$68.00	<u>DN-R15S1</u>	10	\$36.00
	<u>DN-R35S1-2</u>	2	\$11.00	<u>DN-R35HS1-2</u>	2	\$16.50	<u>DN-R15S1-2</u>	2	\$10.00
Description	DINnector DIN rail, slotted, 35mm, 7.5mm height, 1m length, plated steel. Package of 10.			DINnector DIN rail, slotted, 35mm, 15mm height, 1m length, plated steel. Package of 10.			DINnector DIN rail, slotted, 15mm, 5.5mm height, 1m length, plated steel. Package of 2.		
Plating	Zinc-plated and chromated								
International Standards	EN 60715, RoHs								
Suggested Mounting Screw Type	M6			M6			M4		

Aluminum DIN Rail Features

35mm wide

- Non-anodized finish
- Zinc plating and passivation (minimum thickness 6 microns)
- Lightweight, easy to cut and deburr
- Terminal blocks only
- Maximum mounting screw #10-32 or M5
- Available in 1-meter lengths

35mm wide raised

- Non-anodized finish
- Zinc plating and passivation (minimum thickness 6 microns)
- Enables users to raise terminal blocks 2¼" above the back panel
- Terminal blocks only
- Available in 1-meter lengths
- Bushing or grommet recommended for wire access hole (example Heyco UB-875 not sold by ADC)

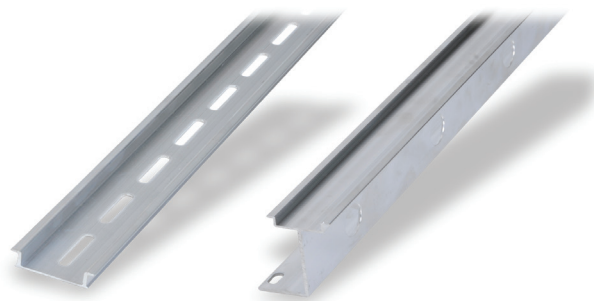

Aluminum DIN Rails Specifications						
	Part Number	Qty	Price	Part Number	Qty	Price
DIN Rail	<u>DN-R35SAL1</u>	10	\$60.00	<u>DN-R35SAL2-2</u>	2	\$38.00
	<u>DN-R35SAL1-2</u>	2	\$16.00			
Description	DINnector DIN rail, slotted, 35mm, 10mm height, 1m length, aluminum. Package of 10.			DINnector DIN rail, slotted, 2in raised 35mm, 7.5mm height, 1m length, aluminum. Package of 2.		
Plating	Galvanic zinc plating, non-anodized finish					
International Standards	DIN 50960, RoHs					
Suggested Mounting Screw Type	#10-32 or M5					

DINnectors Accessories

DIN rail support brackets

- Angled support brackets raise and tilt mounting rails 30 degrees from mounting surface for easier wiring
- [DN-ASB1](#) plated steel support bracket
- [DN-ASB2-10](#) cold-rolled steel treated with galvanic zinc plating and passivation

DIN rail mounting clips

- Snap small devices not made for mounting onto 35mm DIN rails
- Zinc plated steel

DIN Rail Support Brackets and Mounting Clips			
Part Number	Description	Qty	Price
DN-ASB1	30° angled DIN rail support bracket (M6-1.0 screws not included)	50	\$107.00
DN-ASB2-10	30° angled DIN rail support bracket (M6-1.0 screws included)	10	\$18.00
DN-SSB25-10	1" (25mm) DIN rail support bracket (M6-1.0 screws included)	10	\$24.50
DN-SSB50-10	2" (50mm) DIN rail support bracket (M6-1.0 screws included)	10	\$25.50
DN-SSB70-10	2.75" (70mm) DIN rail support bracket (M6-1.0 screws included)	10	\$32.00
DN-SSB90-10	3.5" (90mm) DIN rail support bracket (M6-1.0 screws included)	10	\$34.50
DN-CLIP-FM4	DIN rail mounting clip with M4 x 0.7 mm threaded hole (Screws not included)	40	\$66.00
DN-CLIP-FM4-5		5	\$9.50
DN-CLIP-FM5	DIN rail mounting clip with M5 x 0.8 mm threaded hole (Screws not included)	40	\$66.00
DN-CLIP-FM5-5		5	\$9.50

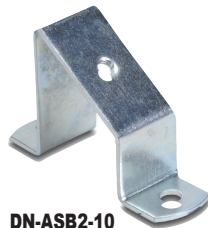
**DN-ASB1****DN-ASB2-10****DN-SSB25-10****DN-SSB50-10****DN-SSB70-10****DN-SSB90-10****DN-CLIP-FM4**
DN-CLIP-FM4-5**DN-CLIP-FM5**
DN-CLIP-FM5-5

DINnectors® Accessories

DIN Rail Support Brackets and Mounting Clips

Dimensions

mm [inches]

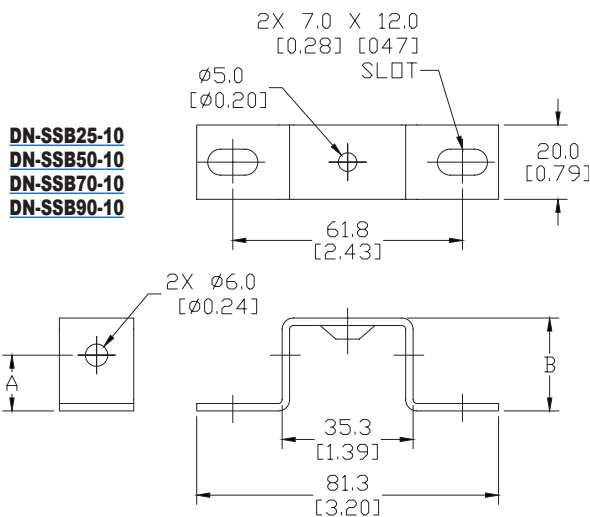
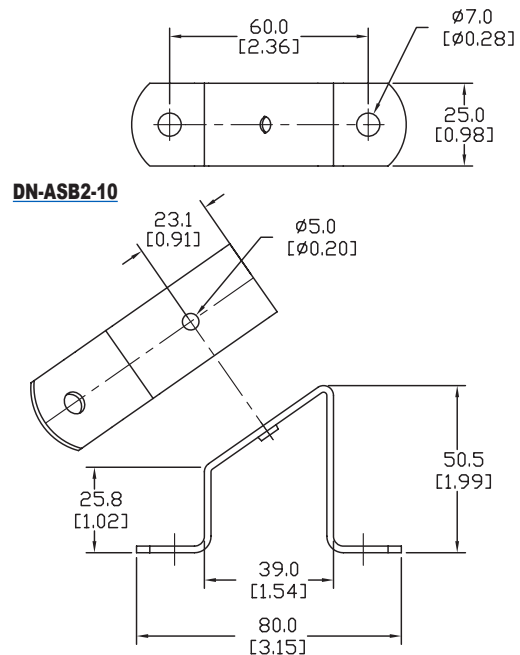
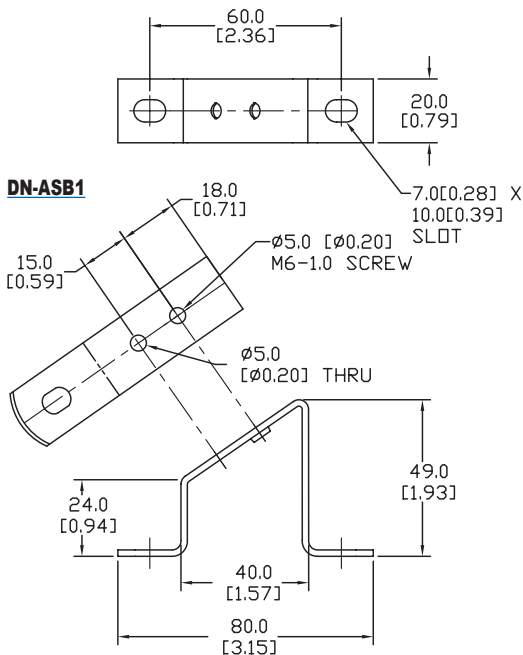

DIN Rail Support Brackets		
Part Number	DIM A mm [inches]	DIM B mm [inches]
DN-SSB25-10	15.0 [0.59]	25.0 [0.98]
DN-SSB50-10	40.0 [1.58]	50.0 [1.97]
DN-SSB70-10	60.0 [2.36]	70.0 [2.76]
DN-SSB90-10	80.0 [3.15]	90.0 [3.54]

See our website: www.AutomationDirect.com for complete engineering drawings

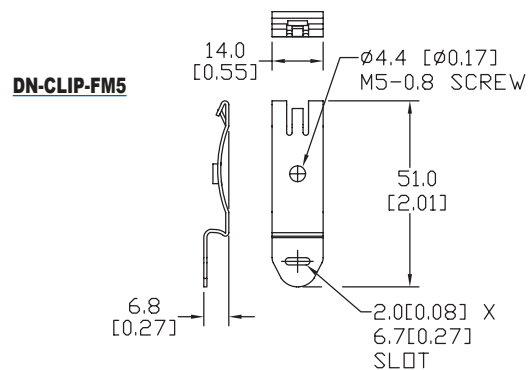
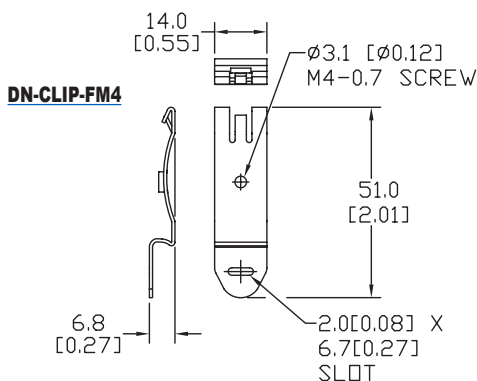

DINnectors® Accessories

Jumpers

Multi-pole jumper bars for DINnector terminal blocks

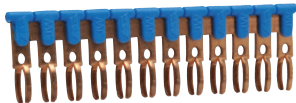

DN-12JL14B-A

Multi-pole Jumper Bars								
Part Number	Qty	Price	# of Poles	Rating		Tightening Torque	Insulation Color	For Use With Terminal Block Series
				(V)	(A)			
Screw-down Connection								
DN-2J6	100	\$76.00	2	600	65	0.5 Nm [4.4 Lb-In]	-	DN-T6
DN-3J6	100	\$132.00	3	600	65		-	
DN-4J6	100	\$169.00	4	600	65		-	
DN-55J6	1	\$26.50	55	600	65		-	
DN-24J8	5	\$41.00	24	600	50	0.6 Nm [5.3 lb-in]	Green	DN-T8
Push-in Connection								
DN-2J2Y	100	\$43.00	2	600	25	-	Orange	DN-T12-A
DN-2J2YMN	25	\$13.00	2	600	25		Orange	DN-EMX
DN-3J2Y	100	\$62.00	3	600	25		Orange	DN-Q12-A
DN-3J2YMN	25	\$18.00	3	600	25		Orange	DN-QD12-A
DN-24J2Y	5	\$28.00	24	600	25		Orange	DN-QEMX
DN-24J2YMN	5	\$28.00	24	600	25		Orange	DN-QKBD12-A
DN-2J4Y	100	\$46.00	2	600	25		Yellow	DN-T10-A
DN-2J4YMN	25	\$14.50	2	600	25		Yellow	
DN-3J4Y	100	\$74.00	3	600	25		Yellow	
DN-3J4YMN	25	\$22.00	3	600	25		Yellow	
DN-24J4Y	5	\$29.50	24	600	25		Yellow	
DN-2JL14-A	100	\$67.00	2	300	20		Red	DN-TL-A
DN-2JL14-AMN	25	\$15.00	2	300	20	Red		
DN-2JL14B-A	100	\$67.00	2	300	20	Blue		
DN-2JL14B-AMN	25	\$15.00	2	300	20	Blue		
DN-3JL14-A	100	\$99.00	3	300	20	Red		
DN-3JL14-AMN	25	\$23.00	3	300	20	Red		
DN-3JL14B-A	100	\$99.00	3	300	20	Blue		
DN-3JL14B-AMN	25	\$23.00	3	300	20	Blue		
DN-12JL14-A	10	\$26.50	12	300	20	Red		
DN-12JL14B-A	10	\$26.50	12	300	20	Blue		
DN-12JFE	10	\$60.00	12	300	25	Blue	DN-FE4	
DN-2J6Y	100	\$60.00	2	600	30	Green	DN-Q8-A	
DN-2J6YMN	25	\$15.00	2	600	30	Green		
DN-3J6Y	100	\$84.00	3	600	30	Green	DN-Q8-A	
DN-3J6YMN	25	\$23.50	3	600	30	Green		
DN-12J6Y	10	\$35.50	12	600	30	Green	DN-Q8-A	

Dimensions

mm [inches]

DN-24J8

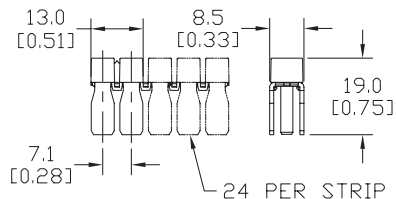

DN-xJ2Y / DN-xJ2YMN

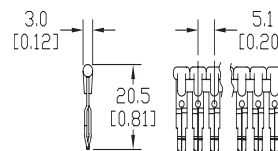

DN-xJ4Y / DN-xJ4YMN

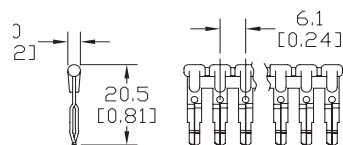

DN-xJL14 / DN-xJL14x-AMN, DN-xJ14x-A

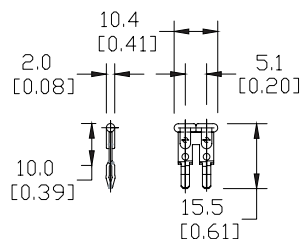

DN-12JFE

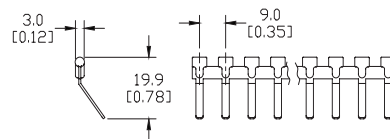

DN-xJ6Y / DN-xJ6YMN

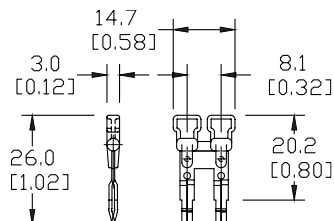

DINnectors® Accessories

Modifying a DN-24J8 jumper bar to the required number of poles

1) Place the insulating part into the jumper bar and insert screws, based on number of poles required.
(For instance, in the following example, 5 poles are required). Click into place.

2) Using a cutting tool, cut the insulating part at the edge of the jumper bar (see below).

3) Hold the metal jumper bar and insulating jumper with two hands, placing fingers to the left and right of the pole you wish to cut, repeatedly flexing up and down (1 or 2 times should be sufficient) until the jumper bar and insulating jumper break in two.

4) Remove the small remaining piece of jumper (see below). This is important to ensure appropriate insulation distance in the case of contiguously applied jumpers in sequence. This step also facilitates the placement of a separator terminal if the bridge is positioned as the last terminal of a group.

5) The jumpers now are ready to be screwed onto DN-T8 series terminal blocks.

Jumper Cutting Tools

Jumper cutting tools maintain protective covering.

Jumper Cutting Tools			
Part Number	Description	Qty	Price
<u>DN-J2CUT</u>	DINnector jumper cutting tool, for use with DN-2J2Y, DN-3J2Y and DN-24J2Y jumpers.	1	\$79.00
<u>DN-J4CUT</u>	DINnector jumper cutting tool, for use with DN-2J4Y, DN-3J4Y and DN-24J4Y jumpers.	1	\$79.00
<u>DN-J6CUT</u>	DINnector jumper cutting tool, for use with DN-12J6Y jumpers.	1	\$118.00
<u>DN-JL14CUT</u>	DINnector jumper cutting tool, for use with DN-12JL14-A and DN-12JL14B-A jumpers.	1	\$112.00
<u>DN-JXCUT</u>	DINnector jumper cutting tool, for use with DN-J2DIE, DN-J4DIE, DN-J6DIE, DN-JL14DIE and DN-JFEDIE dies.	1	\$76.00
<u>DN-JFECUT</u>	DINnector jumper cutting tool, for use with DN-12JFE jumpers.	1	\$92.00
<u>DN-JKIT</u>	DINnector cutting tool kit for DN series jumpers. Includes (1) DN-JXCUT cutting tool, (5) dies (DN-J2DIE, DN-J4DIE, DN-J6DIE, DN-JL14DIE, and DN-JFEDIE).	1	\$313.00
<u>DN-TOOL2</u>	DINnector tool kit, for use with DN series terminal blocks, includes (1) spring opening tool for DN-Q series screwless terminal blocks and (1) jumper removal tool for J2, J4, J6, and JL14 jumpers.	1	\$11.50



DN-J2CUT



DN-J4CUT



DN-JKIT



DN-TOOL2

Replacement Dies		
Part Number	Description	Price
<u>DN-J2DIE</u>	DINnector die set, replacement. Package of 2. For use with jumper cutting tools DN-J2CUT or DN-JXCUT.	\$118.00
<u>DN-J4DIE</u>	DINnector die set, replacement. Package of 2. For use with jumper cutting tools DN-J4CUT or DN-JXCUT.	\$118.00
<u>DN-JFEDIE</u>	DINnector die set, replacement. Package of 2. For use with jumper cutting tools DN-JFECUT or DN-JXCUT.	\$92.00
<u>DN-J6DIE</u>	DINnector die set, replacement. Package of 2. For use with jumper cutting tools DN-J6CUT or DN-JXCUT.	\$118.00
<u>DN-JL14DIE</u>	DINnector die set, replacement. Package of 2. For use with jumper cutting tools DN-JL14CUT or DN-JXCUT.	\$118.00

DINnectors® Accessories

Terminal Plugs



DN-xxPLUG / DN-xxPLUGMN

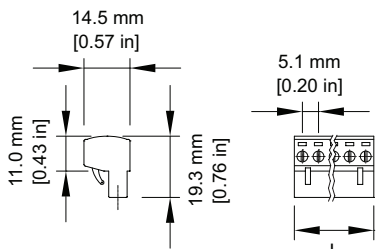

Accessories – Terminal Plugs							
Plugs* Part Number	Qty	Price	Plugs* Part Number	Qty	Price	Number of Poles	Length mm [in]
DN-2PLUG	200	\$115.00	DN-2PLUGMN	10	\$7.25	2	10.2 [0.40]
DN-3PLUG	200	\$177.00	DN-3PLUGMN	10	\$11.50	3	15.2 [0.60]
DN-4PLUG	100	\$118.00	DN-4PLUGMN	10	\$14.50	4	20.3 [0.80]
DN-5PLUG	100	\$136.00	DN-5PLUGMN	10	\$18.00	5	25.4 [1.00]
DN-6PLUG	100	\$176.00	DN-6PLUGMN	10	\$18.00	6	30.5 [1.20]
DN-7PLUG	50	\$92.00	DN-7PLUGMN	5	\$14.50	7	35.6 [1.40]
DN-8PLUG	50	\$117.00	DN-8PLUGMN	5	\$14.50	8	40.6 [1.60]
DN-9PLUG	50	\$128.00	DN-9PLUGMN	5	\$15.00	9	45.7 [1.80]
DN-10PLUG	50	\$136.00	DN-10PLUGMN	5	\$17.00	10	50.8 [2.00]
DN-11PLUG	50	\$161.00	DN-11PLUGMN	5	\$19.50	11	55.9 [2.20]
DN-12PLUG	50	\$176.00	DN-12PLUGMN	5	\$20.00	12	61.0 [2.40]
Terminal Plugs Ratings							
Voltage/Current	300V, 12A						
Wire Gauge	14–22 AWG, CU only						
Torque	Tightening Torque: 0.51 N·m [4.5 lb·in]						
Usage Temperature	Ambient air temperature: -20 to 105°C [-4 to 221°F] Relative humidity: 50% max at 40°C [104°F]; 90% max at 20°C [68°F]						
Agency Approvals	UL file #: E179129						

Note: To obtain the most current agency approval information, see the Agency Approval Checklist section on the specific part number's web page.

* DN-xxPLUGs fit all DN-EMXxx & DN-QEMXxx plug-in terminal blocks

Disconnect Blade



**DN-DIS-BLADE
DN-DIS-BMN**

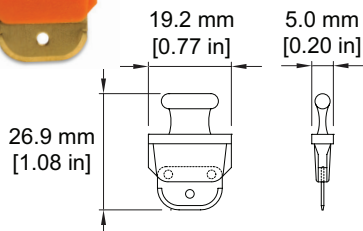

Disconnect Blade			
Part Number	Description	Qty	Price
DN-DIS-BLADE	Terminal block disconnect blade for DN-FE2, DN-FE4, DN-DIS2 and DN-DIS4	50	\$36.00
DN-DIS-BMN		10	\$9.75

End Brackets

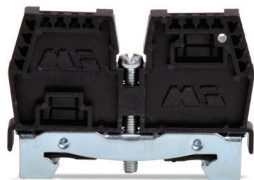

End Brackets		
Part Number	Description	Price
DN-EB15	DINnecter snap-on end bracket, 7mm wide. Package of 100. For use with 15mm DIN rail.	\$108.00
DN-EB15MN	DINnecter snap-on end bracket, 7mm wide. Package of 20. For use with 15mm DIN rail.	\$25.50
DN-EB35	DINnecter screw-down end bracket, 9mm wide. Package of 50. For use with 35mm DIN rail.	\$67.00
DN-EB35MN	DINnecter screw-down end bracket, 9mm wide. Package of 20. For use with 35mm DIN rail.	\$31.50
DN-EB35-A	DINnecter screw-down end bracket, 6mm wide. Package of 50. For use with 35mm DIN rail.	\$47.50
DN-EB35-A-10	DINnecter screw-down end bracket, 6mm wide. Package of 10. For use with 35mm DIN rail.	\$12.00
DN-QEB35	DINnecter snap-on end bracket, 6mm wide. Package of 50. For use with 35mm DIN rail.	\$42.50
DN-QEB35-10	DINnecter snap-on end bracket, 6mm wide. Package of 10. For use with 35mm DIN rail.	\$11.50

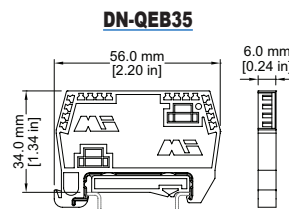
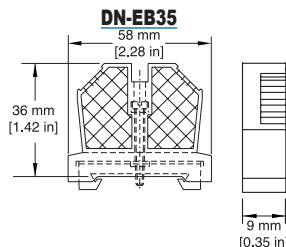
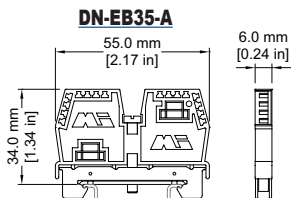
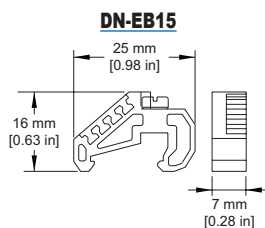

For more information on accessories, see the "DINnectors Accessories" section of this section.

DINnectors Accessories

End Covers

Certain end covers can be used with multiple terminal block parts to cover and insulate the open side, or to put more space between adjacent blocks.

DINnectors End Covers		
Part Number	Description	Price
DN-EC1210	DINnector terminal block end cover, gray. Package of 100. For use with DN-T12 or DN-T10 series terminal blocks.	\$43.00
DN-EC1210MN	DINnector terminal block end cover, gray. Package of 25. For use with DN-T12 or DN-T10 series terminal blocks.	\$14.50
DN-EC86	DINnector terminal block end cover, gray. Package of 100. For use with DN-T8 or DN-T6 series terminal blocks.	\$47.00
DN-EC86MN	DINnector terminal block end cover, gray. Package of 25. For use with DN-T8 or DN-T6 series terminal blocks.	\$14.50
DN-EC4	DINnector terminal block end cover, gray. Package of 50. For use with DN-T4 series terminal blocks.	\$29.50
DN-EC4MN	DINnector terminal block end cover, gray. Package of 10. For use with DN-T4 series terminal blocks.	\$5.75
DN-EC1/0	DINnector terminal block end cover, gray. Package of 50. For use with DN-T1/0 series terminal blocks.	\$33.50
DN-EC1/0MN	DINnector terminal block end cover, gray. Package of 10. For use with DN-T1/0 series terminal blocks.	\$8.00
DN-DEC10	DINnector terminal block end cover, gray. Package of 50. For use with DN-D10-A series terminal blocks.	\$31.50
DN-DEC10MN	DINnector terminal block end cover, gray. Package of 10. For use with DN-D10-A series terminal blocks.	\$6.00
DN-EC14	DINnector terminal block end cover, gray. Package of 25. For use with DN-TL14 series terminal blocks.	\$18.00
DN-EC14S	DINnector terminal block end cover, gray. Package of 25. For use with DN-TL14S series terminal blocks.	\$15.00
DN-ECM10	DINnector terminal block end cover, gray. Package of 100. For use with DN-M10-A series terminal blocks.	\$43.00
DN-ECM10MN	DINnector terminal block end cover, gray. Package of 25. For use with DN-M10-A series terminal blocks.	\$14.50
DN-ECKBD	DINnector terminal block end cover, gray. Package of 100. For use with DN-KBD12 series terminal blocks.	\$43.00
DN-ECKBDMN	DINnector terminal block end cover, gray. Package of 10. For use with DN-KBD12 series terminal blocks.	\$6.00
DN-EMXM1EC1	DINnector terminal block end cover, gray. Package of 25. For use with DN-EMXM1 series terminal block leftside.	\$15.00
DN-EMXM1EC2	DINnector terminal block end cover, gray. Package of 25. For use with DN-EMXM1 series terminal block rightside.	\$15.00
DN-EMXDVEC1	DINnector terminal block end cover, gray. Package of 25. For use with DN-EMXDV series terminal block leftside.	\$15.00
DN-EMXDVEC2	DINnector terminal block end cover, gray. Package of 25. For use with DN-EMXDV series terminal block rightside.	\$15.00
DN-FESEP	DINnector terminal block end cover, gray. Package of 50. For use with DN-FE and DN-DIS series terminal blocks.	\$26.50
DN-FESEP-10	DINnector terminal block end cover, gray. Package of 10. For use with DN-FE and DN-DIS series terminal blocks.	\$5.25
DN-QEC12	DINnector terminal block end cover, gray. Package of 50. For use with DN-Q12-A or DN-QG12 series terminal blocks.	\$21.50
DN-QEC12MN	DINnector terminal block end cover, gray. Package of 10. For use with DN-Q12-A or DN-QG12 series terminal blocks.	\$5.25
DN-QEC10	DINnector terminal block end cover, gray. Package of 50. For use with DN-Q10-A or DN-QG10 series terminal blocks.	\$21.50
DN-QEC10MN	DINnector terminal block end cover, gray. Package of 10. For use with DN-Q10-A or DN-QG10 series terminal blocks.	\$5.25
DN-QEC8	DINnector terminal block end cover, gray. Package of 50. For use with DN-Q8-A or DN-QG8 series terminal blocks.	\$25.50
DN-QEC8MN	DINnector terminal block end cover, gray. Package of 10. For use with DN-Q8-A or DN-QG8 series terminal blocks.	\$5.75
DN-QEC12-1-2	DINnector terminal block end cover, gray. Package of 25. For use with DN-Q12-1-2-A series terminal blocks.	\$15.00
DN-QEC12-2-2	DINnector terminal block end cover, gray. Package of 25. For use with DN-Q12-2-2-A series terminal blocks.	\$16.50
DN-QDEC12	DINnector terminal block end cover, gray. Package of 25. For use with DN-QD12 series terminal blocks.	\$16.50

Spacers

Spacers are used to put more space between adjacent blocks.

DINnectors Spacers			
Part Number	Description	Qty	Price
DN-S1210	Spacer for DN-T12-A and DN-T10-A series terminal blocks	100	\$51.00
DN-S1210MN		25	\$16.00
DN-S86	Spacer for DN-T8 and DN-T6 series terminal blocks	100	\$61.00
DN-S86MN		25	\$14.00
DN-EMXM1SPA1	Spacer for DN-EMXM1 and DN-QEMXM1 single-level plug-in terminal blocks	25	\$13.00
DN-EMXDVSPA1	Spacer for DN-EMXDV and DN-QEMXDV double-level plug-in terminal blocks	25	\$14.50
DN-FESPA	Spacer for DN-FE sockets and DN-DIS disconnects	50	\$26.50
DN-FESPA-10		10	\$5.25

Top Covers

DINnectors Top Covers				
Part Number	Description	For Use With	Qty	Price
DN-C12	Top cover, clear, printed electrical symbol.	DN-T12-A	100	\$62.00
DN-C12MN			25	\$14.00
DN-C10	Top cover, clear, printed electrical symbol.	DN-T10-A	100	\$62.00
DN-C10MN			25	\$14.00
DN-C86	Top cover, clear, printed electrical symbol.	DN-T8 DN-T6	100	\$62.00
DN-C86MN			25	\$14.00
DN-DC10	Top cover, clear, printed electrical symbol.	DN-D10	100	\$60.00
DN-DC10MN			25	\$14.00
DN-MC10	Top cover, clear, printed electrical symbol.	DN-M10	100	\$64.00
DN-MC10MN			25	\$14.00

DINnectors[®] Accessories

Part Number		Length mm[in]	Height mm [in]	Thickness mm [in]
DN-EC1210	DN-EC1210MN	44 [1.73]	35 [1.38]	1.5 [0.06]
DN-S1210	DN-S1210MN	55 [2.17]	44 [1.73]	
DN-EC86	DN-EC86MN	50 [1.97]	43 [1.69]	
DN-S86	DN-S86MN	55 [2.17]	49 [1.93]	
DN-EC4	DN-EC4MN	56 [2.21]	48 [1.89]	
DN-EC1/0	DN-EC1/0MN	62 [2.44]	60 [2.36]	
DN-DEC10	DN-DEC10MN	72 [2.80]	49 [1.93]	
DN-EC14	-	78 [3.08]	55 [2.17]	
DN-EC14S	-	55 [2.17]	50 [1.97]	
DN-ECM10	DN-ECM10MN	32 [1.26]	27 [1.06]	
DN-ECKBD	DN-ECKBDMN	52 [2.05]	34.5 [1.36]	
DN-EMXM1EC1	DN-EMXM1EC2	as shown on next page		
DN-EMXDVEC1	DN-EMXDVEC2			
DN-EMXDVSPA1	DN-EMXM1SPA1			
DN-FESPA	DN-FESPA-10			
DN-FESEP	DN-FESEP-10			
DN-QEC12	DN-QEC12MN	50 [1.97]	23 [0.9]	1.5 [0.06]
DN-QEC10	DN-QEC10MN	57.4 [2.26]	33.6 [1.32]	
DN-QEC8	DN-QEC8MN	63 [2.48]	38.5 [1.52]	
DN-QEC12-1-2	-	68.5 [2.70]	28.5 [1.12]	
DN-QEC12-2-2	-	87.5 [3.44]	28.5 [1.12]	
DN-QDEC12	-	98 [3.86]	37 [1.46]	

DN-EC1210 (MN), DN-EC86 (MN), DN-EC4 (MN), DN-EC1/0 (MN), DN-ECKBD (MN), DN-S1210 (MN), DN-S86 (MN)

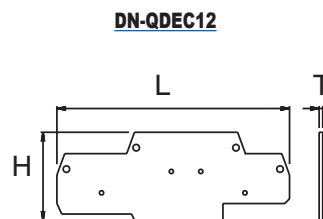
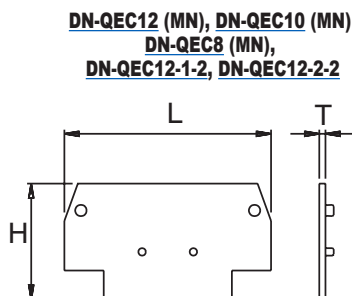
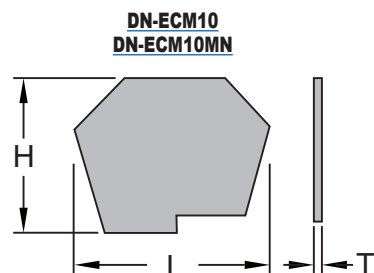
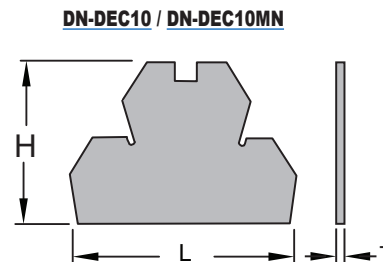
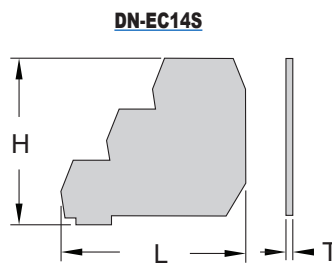
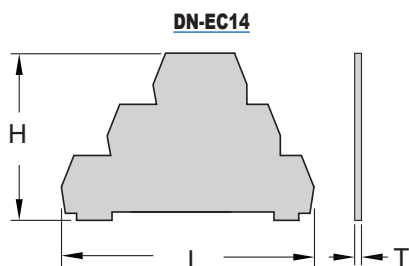
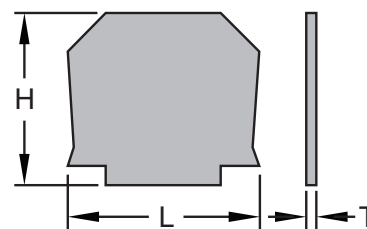

DINnectors[®] Accessories

Dimensional Drawings

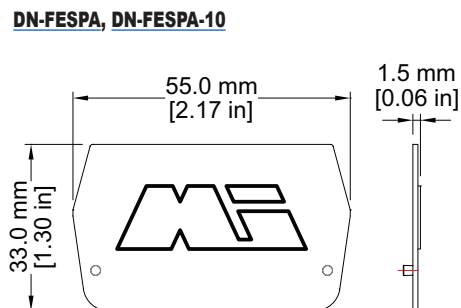
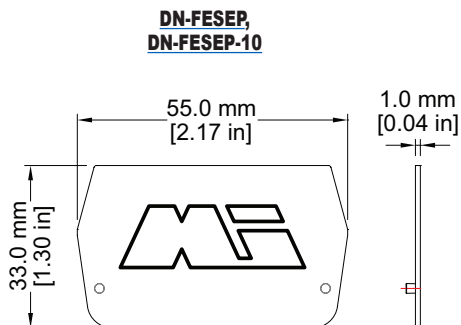
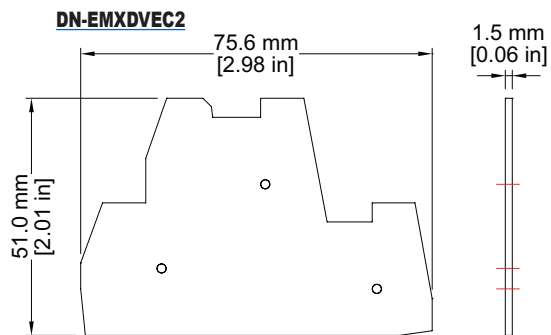
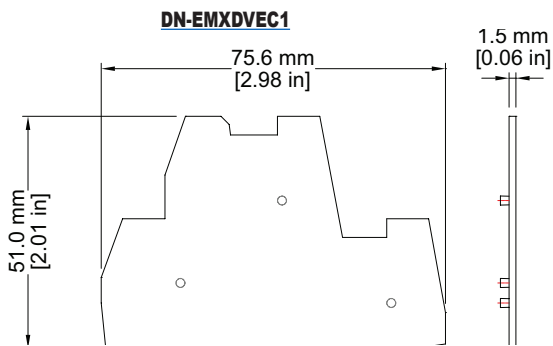
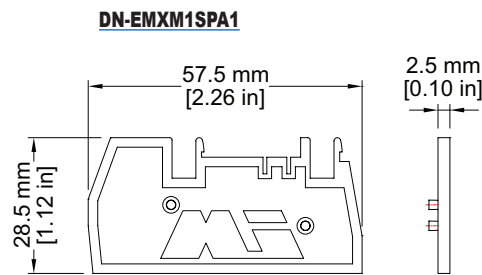
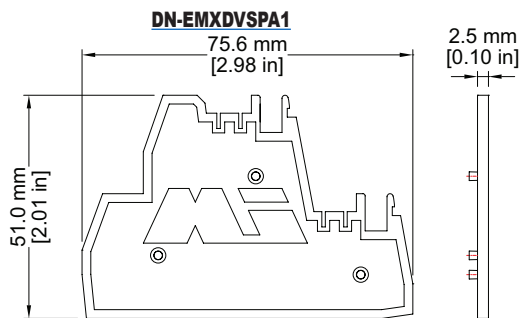
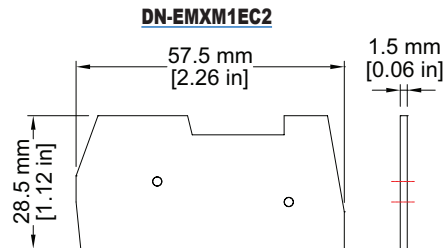
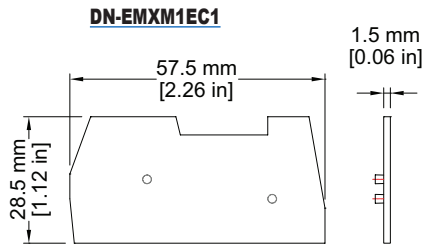



DINnectors Accessories

Marking Tags Cross Reference Charts - Screwless

DINector Marking Tags Cross Reference - Screwless				
<i>Block Type</i>	<i>DN-QL</i>	<i>DN-LA</i>	<i>DN-LT</i>	<i>DN-EMLBL</i>
<i>DN-Q12</i>	X	-	-	-
<i>DN-Q10</i>	X	-	-	-
<i>DN-Q8</i>	X	-	-	-
<i>DN-QD12</i>	X	-	-	-
<i>DN-Q12-1-2</i>	X	-	-	-
<i>DN-Q12-1-2L</i>	X	-	-	-
<i>DN-Q12-1-2D</i>	X	-	-	-
<i>DN-QKBD</i>	X	-	-	-
<i>DN-Q12-2-2</i>	X	-	-	-
<i>DN-Q12-2-2L</i>	X	-	-	-
<i>DN-Q12-2-2D</i>	X	-	-	-
<i>DN-QEMXM1</i>	-	X	X	X
<i>DN-QEMXDV</i>	-	X	X	X
<i>DN-QG12</i>	X	-	-	-
<i>DN-QG10</i>	X	-	-	-
<i>DN-QG8</i>	X	-	-	-
<i>DN-QG12-1-2</i>	X	-	-	-
<i>DN-QG12-2-2</i>	X	-	-	-

Marking Tags

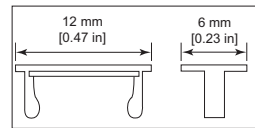
Marking Tags DN-L Series			
Part Number	Marking Sequence	Qty	Price
DN-L50	1-50	500	\$56.00
DN-L100	51-100	500	\$56.00
DN-L150	101-150	500	\$56.00
DN-L200	151-200	500	\$56.00
DN-L250	201-250	500	\$56.00
DN-L300	251-300	500	\$56.00
DN-L350	301-350	500	\$56.00
DN-L400	351-400	500	\$56.00
DN-L450	401-450	500	\$56.00
DN-LB	Blank	500	\$38.00
DN-LS	L1, L2, L3, L, N, GND, +, -, COM, COM*	500	\$56.00

Dimensions

- The marking sequence of 50 tags (i.e. 101-150) is printed 10 times in each package of 500.
- The DN-L tags fit all DINnectors 6mm wide and wider.
- There will be a gap between tags on blocks wider than 6mm.
- Material: Thermoplastic with heat embossed black print.

Marking Tags DN-LA Series			
Part Number	Marking Sequence	Qty	Price
DN-LA100	1-100	500	\$56.00
DN-LA200	101-200	500	\$56.00
DN-LA300	201-300	500	\$56.00
DN-LA400	301-400	500	\$56.00
DN-LAB	Blank Tags	500	\$56.00
DN-LAS	L1, L2, L3, L, N, GND, +, -, COM, COM*	500	\$56.00

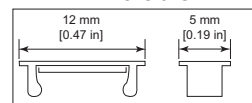
Dimensions

- The marking sequence of 100 tags (i.e. 1-100) is printed five times in each package of 500.
- The DN-LA tags fit all DINnectors 5mm wide and wider. There will be a gap between tags on blocks wider than 5mm.
- Material: Thermoplastic with heat embossed black print.

Marking Tags DN-LAT Series			
Part Number	Marking Sequence	Qty	Price
DN-LAT100-A	1-100	500	\$49.00
DN-LAT200-A	101-200	500	\$49.00
DN-LAT300-A	201-300	500	\$49.00
DN-LAT400-A	301-400	500	\$49.00
DN-LAT500-A	401-500	500	\$49.00
DN-LAT600-A	501-600	500	\$49.00
DN-LATB-A	Blank Tags	500	\$35.50
DN-LATS-A	L1, L2, L3, L, N, +, -, COM, COM*	500	\$49.00

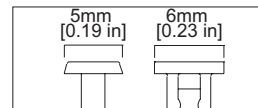
Dimensions

- The marking sequence of 500 tags (i.e. 1-100) is printed five times in each package of 500.
- Material: Thermoplastic with heat embossed black print.

Marking Tags DN-QL Series			
Part Number	Marking Sequence	Qty	Price
DN-QL100	1-100	500	\$42.50
DN-QL200	101-200	500	\$42.50
DN-QL300	201-300	500	\$42.50
DN-QL400	301-400	500	\$42.50
DN-QL500	401-500	500	\$42.50
DN-QLB	Blank Tags	500	\$36.00
DN-QLS	L1, L2, L3, L, N, +, -, COM, COM*	500	\$49.00

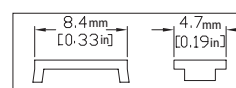
Dimensions

- The marking sequence of 500 (i.e. 1-100) is printed five times in each package of 500.
- Material: Thermoplastic with heat embossed black print.

DINnectors® Accessories

Marking Tags continued

Marking Tags DN-LT Series			
Part Number	Marking Sequence	Qty	Price
DN-LT15	1-5	100	\$10.00
DN-LT60	6-0	100	\$10.00
DN-LT1	1	100	\$10.00
DN-LT2	2	100	\$10.00
DN-LT3	3	100	\$10.00
DN-LT4	4	100	\$10.00
DN-LT5	5	100	\$10.00
DN-LT6	6	100	\$10.00
DN-LT7	7	100	\$10.00
DN-LT8	8	100	\$10.00
DN-LT9	9	100	\$10.00
DN-LT0	0	100	\$10.00
DN-LTBLNK	Unprinted	100	\$10.00
DN-LTA	A	100	\$10.00
DN-LTB	B	100	\$10.00
DN-LTC	C	100	\$10.00
DN-LTD	D	100	\$10.00
DN-LTE	E	100	\$10.00
DN-LTF	F	100	\$10.00
DN-LTG	G	100	\$10.00
DN-LTH	H	100	\$10.00
DN-LTI	I	100	\$10.00
DN-LTJ	J	100	\$10.00
DN-LTK	K	100	\$10.00
DN-LTL	L	100	\$10.00
DN-LTM	M	100	\$10.00
DN-LTN	N	100	\$10.00
-	-	-	-
DN-LTP	P	100	\$10.00
DN-LTQ	Q	100	\$10.00
DN-LTR	R	100	\$10.00
DN-LTS	S	100	\$10.00
DN-LTT	T	100	\$10.00
DN-LTU	U	100	\$10.00
DN-LTV	V	100	\$10.00
DN-LTW	W	100	\$10.00
DN-LTX	X	100	\$10.00
DN-LTY	Y	100	\$10.00
DN-LTZ	Z	100	\$10.00
DN-LTGND	⊕	100	\$10.00
DN-LTPOS	+	100	\$10.00
DN-LTNEG	-	100	\$10.00
DN-LTAC	~	100	\$10.00
DN-LTDC	=	100	\$10.00

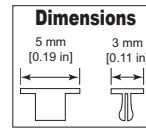

- These marking tags allow the flexibility of creating custom marking sequences on site.
- The DN-M series supports a maximum of three digits (tags), while other DINnectors support up to four digits (tags).
- Material: Thermoplastic with heat embossed black print.

DN-MTA marking tag adapter

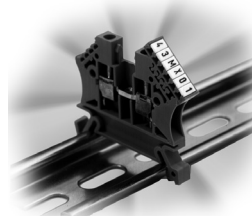

DN-MTA dimensions

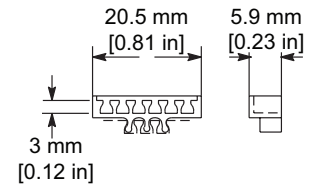

Part Number	Description	Qty	Price
DN-MTA	Marking tag adapter holds up to six DN-LT tags	50	\$14.50

Note: [DN-MTA](#) adapter does not fit [DN-T12-A](#) terminal blocks.

DINnectors® Accessories

Terminal Marking Accessories



DN-EMLBL1



DN-EMLBL2



DN-EMLBL3

Part Number	Description	For Use With	Qty	Price
DN-EMLBL1	Blank labels	DN-EMPEG1 pin protectors for DN-xEMxx plug-in terminal blocks	100	\$9.25
DN-EMLBL2	Labels printed 1 – 12		100	\$13.00
DN-EMLBL3	Labels printed 13 – 24		100	\$13.00

Marking Pen – for terminal and wire marking tags

- Permanent
- Smudge-proof
- Waterproof
- Weatherproof
- Lightfast (won't fade)
- Dries in seconds (excellent for left-handed users)
- Dry-safe (pen can be left uncapped for days without drying out)
- Low odor ink

Part Number	Description	Qty	Price
DN-MP	Staedtler-Mars marking pen, for use with blank marking tags. Permanent Ink, fine tip.	1	\$4.50



Marking pen

Wire Marking Accessories



DN-WMTAG1 wire tags & DN-WM-x wire tag holders

Part Number	Description	For Use With	Qty	Price
DN-WMTAG1	Wire tag – blank	all DN-WM-x wire tag holders	525	\$60.00
DN-WM-1	Wire tag holder, clear, 12mm length, 0.051–0.118 in diameter; for 22–16 AWG wire	DN-WMTAG1	200	\$12.50
DN-WM-2	Wire tag holder, clear, 12mm length, 0.098–0.196 in diameter; for 16–11 AWG wire		200	\$12.50
DN-WM-3	Wire tag holder, clear, 12mm length, 0.157–0.393 in diameter; for 13–5 AWG wire		100	\$8.25
DN-WM-4	Wire tag holder, clear, 12mm length, 0.314–0.629 in diameter; for 5AWG wire		100	\$7.75