

S8 Series Contrast Sensors



Contrast Sensor

- Datalogic® print mark contrast sensor
- RGB light emission
- Horizontal spot orientation
- 6 – 12mm sensing distance
- 12 to 30VDC operating voltage
- Light-on/Dark-on Selectable
- NPN or PNP
- 25 kHz switching frequency
- 316L stainless steel or plastic housing
- Teach-in sensitivity adjustment
- 4-pin M8 quick-disconnect or 150mm cable with M12 quick-disconnect (Purchase cable separately)
- IP67/IP69K
- Mounting brackets also available



S8 Series Contrast Sensors Selection Chart									
Part Number	Price	Sensing Range	Spot Orientation	Switching Frequency	Output State	Logic	Connection	Wiring	Dimensions
Stainless Steel									
S8-MR-5-W13-NN	\$111.00	6–12 mm [0.2–0.5 in]	Horizontal	25kHz	Light-on/Dark-on Selectable	NPN	4-pin M8 quick-disconnect	Diagram 1	Figure 1
S8-MR-5-W13-PP	\$111.00					PNP			
Plastic									
S8-PR-3-W13-NN	\$82.00	6–12 mm [0.2–0.5 in]	Horizontal	25kHz	Light-on/Dark-on Selectable	NPN	150mm cable with M12 quick-disconnect	Diagram 1	Figure 2
S8-PR-3-W13-PP	\$82.00					PNP			
S8-PR-5-W13-NN	\$80.00					NPN	4-pin M8 quick-disconnect		Figure 3
S8-PR-5-W13-PP	\$80.00					PNP			

Wiring Diagrams

Diagram 1

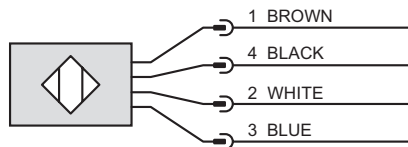

- Pin 1 – Supply Voltage
- Pin 4 – NPN/PNP Output
- Pin 2 – Remote Input
- Pin 3 – 0 VDC

Connectors

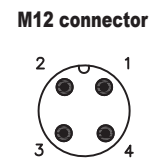
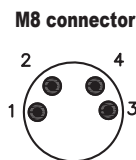

Note: Wiring colors are based on AutomationDirect 4-pole cable assemblies. Class 2 power supply required.

S8 Series Contrast Sensors

Dimensions

mm [inches]

Figure 1

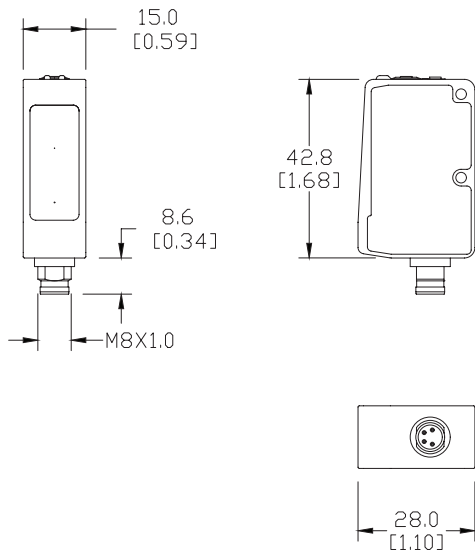

Figure 2

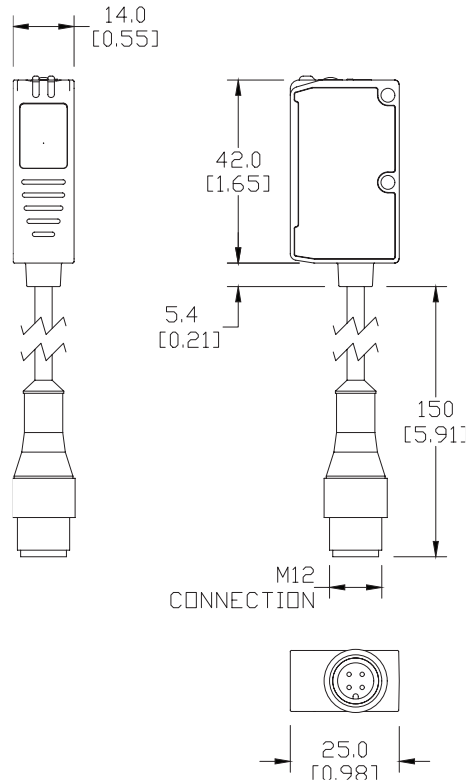
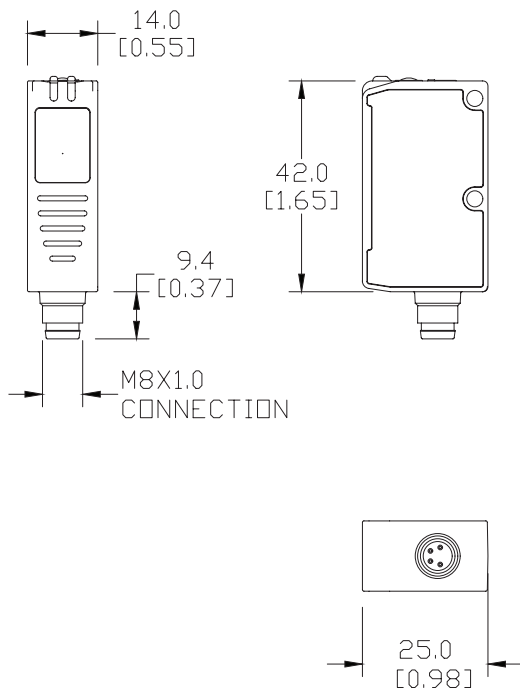

Figure 3



See our website: www.AutomationDirect.com for complete Engineering drawings.

S8 Series Contrast Sensors

Specifications	
Sensing Distance	6–12 mm [0.2–0.5 in]
Spot Dimension	3x1 mm ²
Spot Orientation	Horizontal
Emission	RGB LEDs: Blue [465nm]/ Green [520nm]/Red [630nm] with automatic selection
Sensitivity	Yes via teach-in button/remote signal
Output Type	NPN or PNP; Light-On/Dark-On selectable
Operating Voltage	12 to 30 VDC
No-load Supply Current	≤ 30mA
Operating (Load) Current	≤ 100mA
Off-state (Leakage) Current	Max source current: 40 μA Max sink current: 200 μA
Voltage Drop	≤ 2V
Switching Frequency	25 kHz
Response Time	20μs
Differential Travel	<20mV
Jitter	10μS
Ripple	≤2 Vpp
Time Delay Before Availability (tv)	N/A
Reverse Polarity Protection	Yes
Short-Circuit Protection	Yes
Operating Temperature	-10 to 55°C [14 to 131°F]
Protection Degree (DIN 40050)	IP67 (S8-PR) / IP69K (S8-MR)
Indication/Switch Status	Output LED (Yellow) / Ready LED (Green)
Housing Material	ABS (S8-PR) / INOX AISI 316L (S8-MR)
Sensing Face Material	Glass window; PC (S8-PR) lens / PMMA (S8-MR) window
Shock	EN60068-2-27
Vibration	EN60068-2-6
Weight	12g [0.42 oz] max. (S8-PR connector) 50g [1.76 oz] max pig-tail (S8-PR pig-tail) 70g [2.5 oz] max (S8-MR connector)
Connectors	M8 4-pole connector / 150mm cable with M12 4-pole connector (S8-PR pigtail)
Agency Approvals	CE cULus E227487

Note: To obtain the most current agency approval information– see the Agency Approval Checklist section on the specific part number's web page.

Accessories for S8 Series Contrast Photoelectric Sensors

Mounting Brackets

Accessories for S8 Series Contrast Photoelectric Sensors				
Part Number	Price	Description	Drawing Link	Weight [lb]
ST-S8-FRM	\$9.25	Datalogic mounting bracket, vertical, 304 stainless steel. For use with S8 series contrast sensors.	PDF	0.48
ST-5072	\$12.00	Datalogic mounting bracket, right-angle, 304 stainless steel. For use with S8 series contrast sensors.	PDF	0.10



[ST-S8-FRM](#)

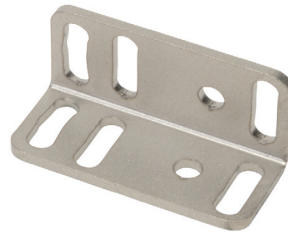

[ST-5072](#)