

ReeR Safegate Light Curtains – Body Protection

Safegate Type 4 access control barriers provide the ideal solution for protection in a wide range of high-risk industrial applications, in particular those requiring a high level of integration of the muting functions. Safegate greatly simplifies seamless integration of muting sensors with light curtain access control barriers

**Hardware configuration
with integrated status and muting lamp**

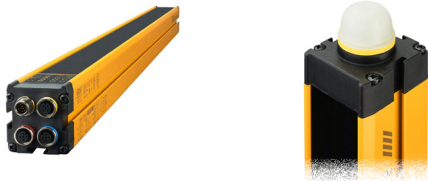

SMO-3B, SMO-4B, SMO-3B-TRX, SMO-4B-TRX

**Hardware or software configuration with
integrated status and muting lamp**



SMPO-3B, SMPO-4B, SMPO-3B-TRX, SMPO-4B-TRX

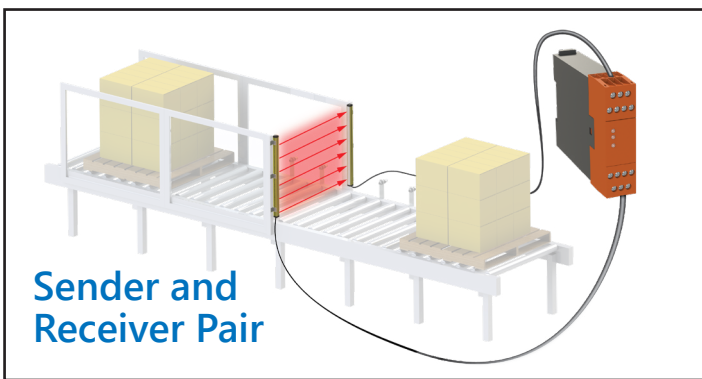

SMO-3B, SMO-4B, SMPO-3B, SMPO-4B

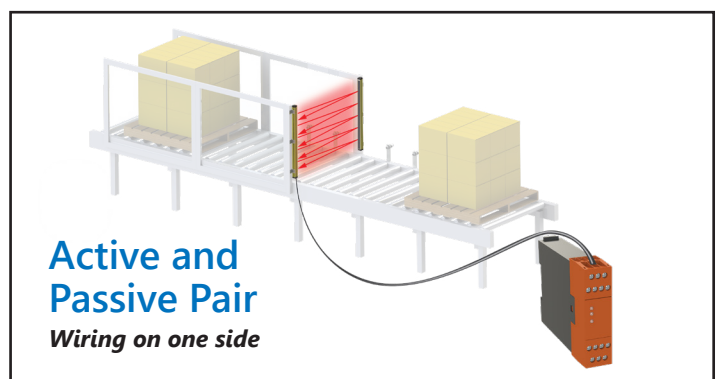

SMO-3B-TRX, SMO-4B-TRX, SMPO-3B-TRX, SMPO-4B-TRX

One way (2 sensor) crossed

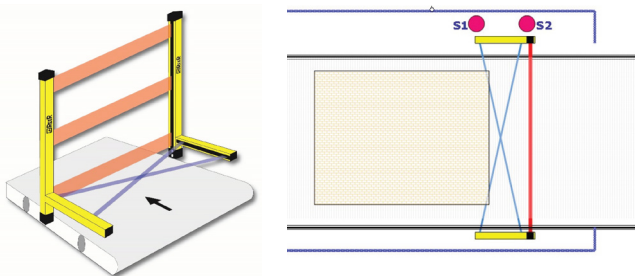

MA-L2X, MZ-L2XP, MZ-L2XP-TRX

One way (2 sensor) parallel

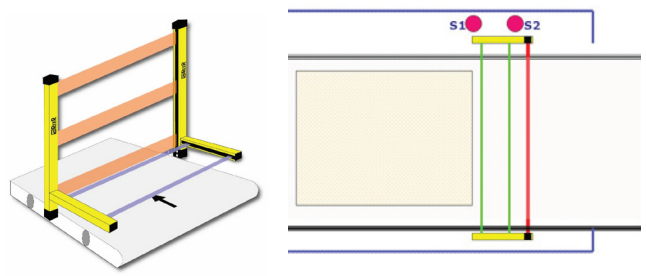

MA-L2P-TRX, MZ-L2XP, MZ-L2XP-TRX

Two way (2 sensor) crossed

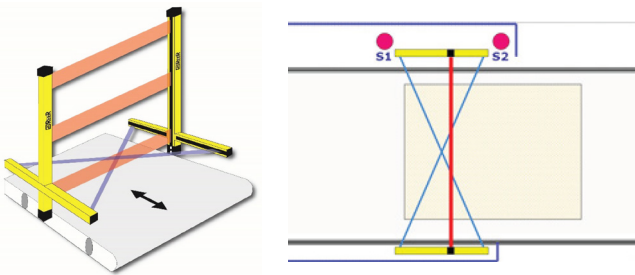

MA-T2X, MZ-T2X, MZ-T2X-TRX

Two way (4 sensor) parallel

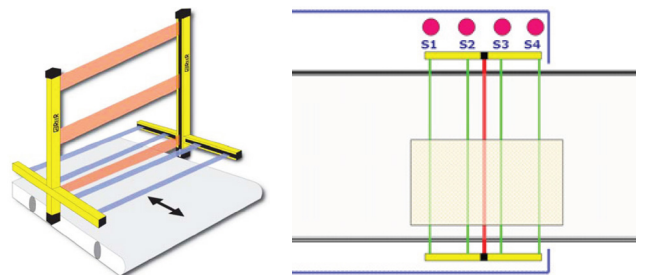

MA-T4P-TRX, MZ-T4P, MZ-T4P-TRX

ReeR Safegate Light Curtains – Body Protection

With Muting Arm/Brackets

Muting Arms:
[MA-L2X](#)
[MA-T2X](#)
[MA-L2P-TRX](#)
[MA-T4P-TRX](#)
 or
Muting Brackets:
[MZ-L2XP](#)
[MZ-T2X](#)
[MZ-T4P](#)
[MZ-L2XP-TRX](#)
[MZ-T2X-TRX](#)
[MZ-T4P-TRX](#)

Cable
 M12 12-pin cable
(See recommended items for cabling)

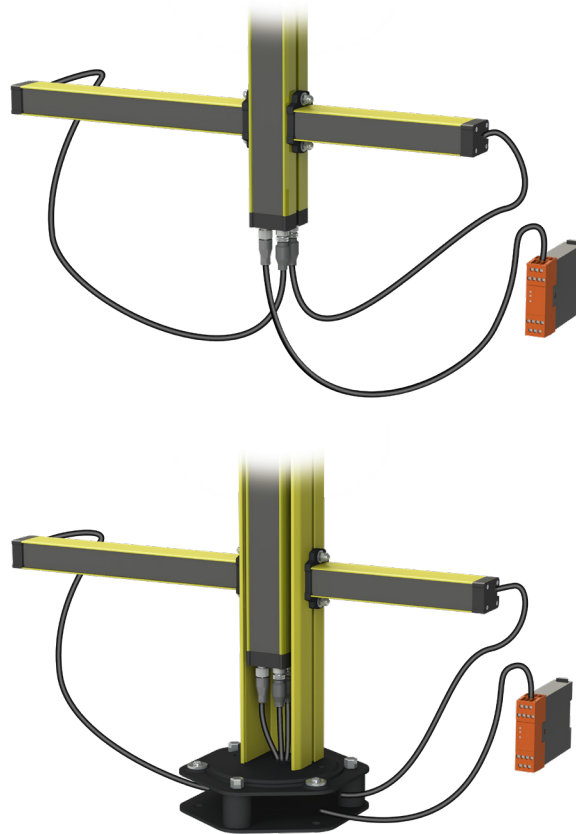

Light Curtains:
[SMO-3B](#)
[SMO-4B](#)
[SMPO-3B](#)
[SMPO-4B](#)
[SMO-3B-TRX](#)
[SMO-4B-TRX](#)
[SMPO-3B-TRX](#)
[SMPO-4B-TRX](#)
If a TRX light curtain is selected, then the muting arms/brackets part number should end in TRX as well.

Protective Columns (optional)
[FMC-SGB3](#) (for SMxO-3B or SMxO-3B-TRX)
[FMC-SGB4](#) (for SMxO-4B or SMxO-4B-TRX)
Protective Column Base:
(Required with Protective Column)
[FMC-CB](#) (shown)
 or
[FMC-CBL](#) (not shown)

With Muting Photocells

Photo Cells
[M5-A](#)
[M5-B](#)
[M-TRX-A](#)
[M-TRX-B](#)

Y-Splitters
[CSY12TX](#)
[CSY12RX](#)

Cable
 M12 12-pin cable
(See recommended items for cabling)

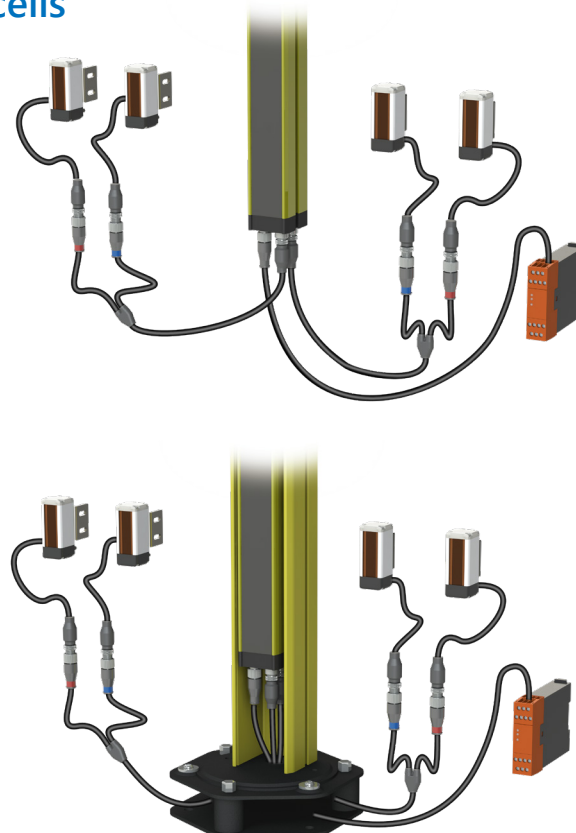

Light Curtain:
[SMO-3B](#)
[SMO-4B](#)
[SMPO-3B](#)
[SMPO-4B](#)
[SMO-3B-TRX](#)
[SMO-4B-TRX](#)
[SMPO-3B-TRX](#)
[SMPO-4B-TRX](#)
If a TRX light curtain is selected, then the muting arms/brackets part number should end in TRX as well.

Protective Columns (optional)
[FMC-SGB3](#) (for SMxO-3B or SMxO-3B-TRX)
[FMC-SGB4](#) (for SMxO-4B or SMxO-4B-TRX)
Protective Column Base:
(Required with Protective Column)
[FMC-CB](#) (shown)
 or
[FMC-CBL](#) (not shown)

ReeR Safegate Light Curtains – Body Protection



Features

- Integrated muting functions
- Pre-configured and pre-wired muting arms and muting brackets (sold separately)
- Hardware or software configuration options
- Bright LED status and muting lamp
- Status display on unit
- Fully scalable
- Passive retro-reflective elements available (TRX)

Benefits of Software Configurable Models (SMPO-xxx)

- Upload/download settings
- Specify muting parameters
- Utilize up to two partial muting configurations
- Check and validate programmable configuration
- Light curtain status and monitoring
- Free configuration software

| ReeR Safegate Light Curtains – Body Protection With Muting Functions – Selection Chart | | | | | | | | | | | | |
|--|------------|------------------------------|---------------------------|-------------------------|-----------------|----------|--------------------|---------------|-------|----------------|--------------------|---------------------|
| Part Number | Price | Protective Height Hs mm [in] | Housing Height Hb mm [in] | Total Height Ht mm [in] | Number of Beams | PFHd | Response Time [ms] | MTTFd [years] | DCavg | Weight kg [lb] | Resolution mm [in] | Dimensional Drawing |
| Sender and Receiver Pair | | | | | | | | | | | | |
| <i>Hardware configuration with integrated status and muting LED</i> | | | | | | | | | | | | |
| SMO-3B | \$985.00 | 810 [31.89] | 974 [38.33] | 1010 [39.76] | 3 | 9.63E-09 | 5.5 | 262.4 | 98.5% | 6.08 [13.40] | 400 [15.75] | PDF |
| SMO-4B | \$1,058.00 | 910 [35.83] | 1073 [42.24] | 1110 [43.70] | 4 | 1.03E-08 | 5.5 | 253.3 | 98.4% | 6.56 [14.46] | 300 [11.81] | PDF |
| <i>Hardware or software configuration with integrated status and muting LED</i> | | | | | | | | | | | | |
| SMPO-3B | \$1,006.00 | 810 [31.89] | 974 [38.33] | 1010 [39.76] | 3 | 9.63E-09 | 5.5 | 262.4 | 98.5% | 6.08 [13.40] | 400 [15.75] | PDF |
| SMPO-4B | \$1,150.00 | 910 [35.83] | 1073 [42.24] | 1110 [43.70] | 4 | 1.03E-08 | 5.5 | 253.3 | 98.4% | 6.56 [14.46] | 300 [11.81] | PDF |
| Active and Passive Pair | | | | | | | | | | | | |
| <i>Hardware configuration with integrated status and muting LED</i> | | | | | | | | | | | | |
| SMO-3B-TRX | \$985.00 | 810 [31.89] | 935 [36.79] | 970 [38.19] | 3 | 7.58E-09 | 5.5 | 401.0 | 98.2% | 5.98 [13.18] | 400 [15.75] | PDF |
| SMO-4B-TRX | \$1,058.00 | 910 [35.83] | 1035 [40.73] | 1070 [42.13] | 4 | 7.68E-09 | 5.5 | 399.4 | 99.2% | 6.54 [14.42] | 300 [11.81] | PDF |
| <i>Hardware or software configuration with integrated status and muting LED</i> | | | | | | | | | | | | |
| SMPO-3B-TRX | \$1,006.00 | 810 [31.89] | 935 [36.79] | 970 [38.19] | 3 | 7.58E-09 | 5.5 | 401.0 | 98.2% | 5.98 [13.18] | 400 [15.75] | PDF |
| SMPO-4B-TRX | \$1,150.00 | 910 [35.83] | 1035 [40.73] | 1070 [42.13] | 4 | 7.68E-09 | 5.5 | 399.4 | 99.2% | 6.54 [14.42] | 300 [11.81] | PDF |

Note: SMO and SMPO are designed to work with integrated muting arms, brackets, or photocells and do not work as stand-alone access barriers.

Dimensions (see table above)

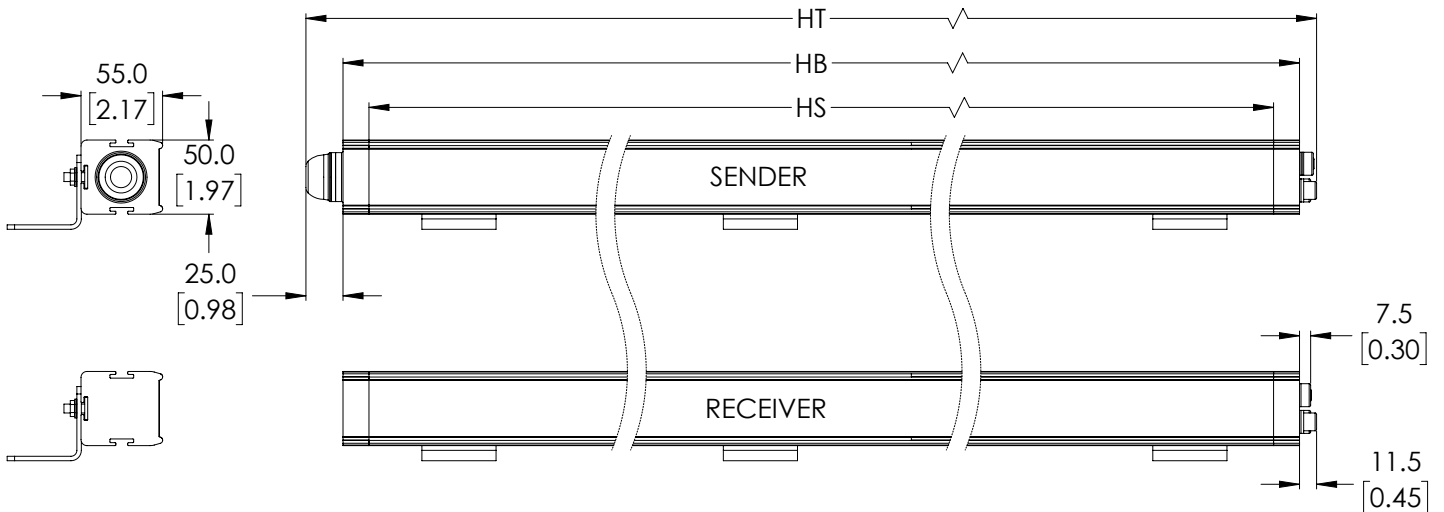

ReeR Safegate Light Curtains – Body Protection

| ReeR Safegate Light Curtains – Body Protection With Muting Functions – Specifications | | | | | |
|---|--------|---|--|--|--|
| | | Sender and Receiver Pair | | Active and Passive Pair | |
| | | SMO-3B, SMO-4B | SMPO-3B, SMPO-4B | SMO-3B-TRX, SMO-4B-TRX | SMPO-3B-TRX, SMPO-4B-TRX |
| Supply Voltage | | 24VDC ±20% | | 24VDC ±20% | |
| Safety Outputs (OSSDs) | | 2 PNP – 400mA @ 24VDC | | 2 PNP – 400mA @ 24VDC | |
| Status Outputs | | 1 PNP – 100mA @ 24VDC | | 1 PNP – 100mA @ 24VDC | |
| Operating Temperature | | -30°C to 55°C [-22°F to 131°F] | | -30°C to 55°C [-22°F to 131°F] | |
| LED Status Lamp | | LED indication of Muting and Curtain Status on RX Curtain | LED indication of Muting, Curtain Status, and Override on RX Curtain | LED indication of Muting and Curtain Status on Active Curtain | LED indication of Muting, Curtain Status, and Override on Receiver Curtain |
| Safety Category | Type 4 | EN 61496-1:2013 IEC 61496-2:2013 | | EN 61496-1:2013 IEC 61496-2:2013 | |
| | SIL3 | IEC 61508-1: (ed.2) IEC 61508-2: (ed.2) IEC 61508-3: (ed.2) IEC 61508-4: (ed.2) | | IEC 61508-1: (ed.2) IEC 61508-2: (ed.2) IEC 61508-3: (ed.2) IEC 61508-4: (ed.2) | |
| | PLe | EN ISO 13849-1:2015 | | EN ISO 13849-1:2015 | |
| | CAT4 | EN ISO 13849-1:2015 | | EN ISO 13849-1:2015 | |
| CCF | | 80% | | 80% | |
| Degree of Protection | | IP65 and IP67 | | IP65 and IP67 | |
| Working Range | | 0-4 m [0-13.12 ft] low 0-12 m [0-39.37 ft] high (See Range/Test Selection Chart on next page) | | 0-8 m [0-26.25 ft] | |
| Power Consumption | | Transmitter: 1W; Receiver: 2W | | 3W | |
| Connections | | Power on TX: M12 5-pin male Power on RX: M12 12-pin male Muting sensor connectors/muting lamp/configuration: Two M12 5-pin female | | Power on Active: M12 12-pin male Muting sensor connectors/muting lamp/configuration: Two M12 5-pin female | |
| EDM Input | | Available on RX, selectable | | Available on Active, selectable | |
| Restart Auto/Manual | | Available on RX, selectable | | Available on Active, selectable | |
| Test Input | | Available on TX, selectable | | Not available | |
| Configuration | | Hardware on RX connector | Hardware or software with USB | Hardware on active element connector | Hardware or software with USB |
| Conductor requirements | | 20AWG if length is less than 50m [164.04 ft] 17AWG if length is between 50m [164.04 ft] and 100m [328.1 ft] | | 20AWG if length is less than 50m [164.04 ft] 17AWG if length is between 50m [164.04 ft] and 100m [328.1 ft] | |
| Max Connection Length | | 100m [328.1 ft] | | 100m [328.1 ft] | |
| Current Rating Available for Muting Sensors | | 50mA | | 50mA | |
| Muting Lamp Output | | 24VDC, 0.5 to 5 W | | 24VDC, 0.5 to 5 W | |
| Muting Signal Response Time (Sensors) | | 100ms | | 100ms | |
| Muting Signal Logic Levels (Sensors) | | <5VDC: Clear Sensor 11-30 VDC: Actuated Sensor | | <5VDC: Clear Sensor 11-30 VDC: Actuated Sensor | |
| Time Out Muting | | 30s 9h (non-sequential) Can be excluded (sequential) | Configurable via software | 30s 9h (non-sequential) Can be excluded (sequential) | Configurable via software |
| Muting Override | | Selectable by pulse or by action maintained | Selectable by pulse or by action maintained; configurable via software | Selectable by pulse or by action maintained | Selectable by pulse or by action maintained; configurable via software |
| Override Max Timeout | | 15m (renewable) | 15m (renewable) software configurable | 15m (renewable) | 15m (renewable) software configurable |
| Maximum Number of Consecutive Overrides | | 30 | | 30 | |
| Muting Logic | | Crossed beams or sequential | Fully configurable with ReeR software | Crossed beams or sequential | Fully configurable with ReeR software |
| Partial Muting | | NA | Possibility to interrupt only a selected number of beams | NA | Possibility to interrupt only a selected number of beams |
| Tolerance Time Between Sensors 1 and 2 | | 4s | 2 to 5 s Configurable via software | 4s | 2 to 5 s Configurable via software |
| Muting Enable | | Pin on main connector, disabled if not required and monitored | | Pin on main connector, disabled if not required and monitored | |

ReeR Safegate Light Curtains – Body Protection

Pin outs for [SMO-3B-TRX](#), [SMO-4B-TRX](#), [SMPO-3B-TRX](#) and [SMPO-4B-TRX](#)

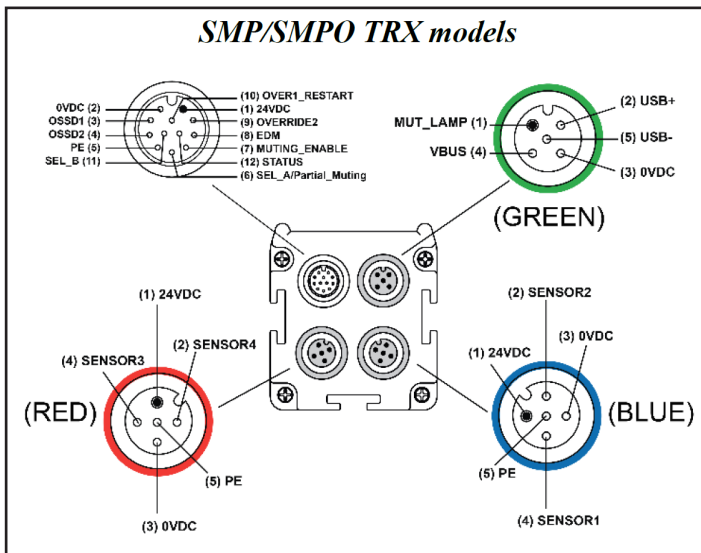
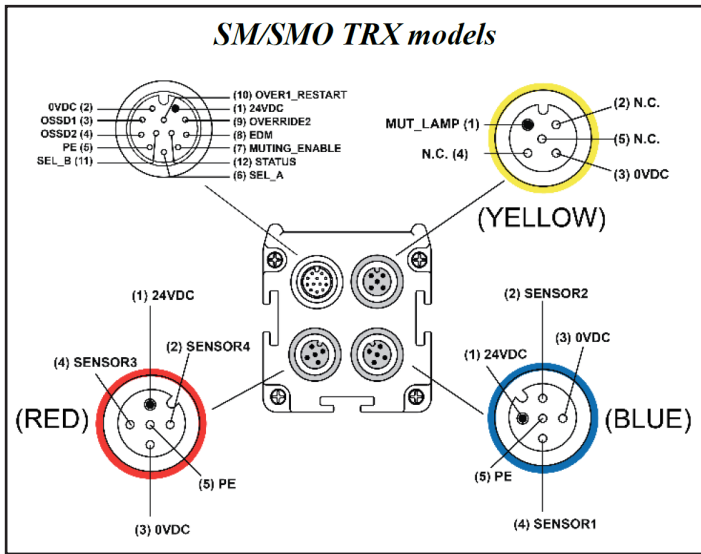

PRIMARY M12 12-PIN MALE CONNECTOR

| Pin | Color | Signal | In/Out | Description |
|-----|-----------|--------------------------------|--------|------------------------|
| 1 | Brown | 24VDC | - | 24VDC power supply |
| 2 | Blue | 0VDC | - | 0VDC power supply |
| 3 | White | OSSD1 | Output | Safety static outputs |
| 4 | Green | OSSD2 | Output | |
| 5 | Pink | PE | - | Ground connection |
| 6 | Yellow | SEL_A | Input | Muting configuration |
| | | PARTIAL_MUTING_A (see note) | | Partial muting control |
| 7 | Black | MUT_ENABLE | Input | External muting enable |
| 8 | Gray | EDM | Input | K1/K2 feedback |
| 9 | Red | OVERRIDE2 | Input | Override request |
| 10 | Purple | OVERRIDE1 | Input | Override request |
| | | RESTART | | Restart interlock |
| 11 | Grey/Pink | SEL_B | Input | Muting configuration |
| 12 | Red/Blue | STATUS | Output | System status |

NOTE: PARTIAL_MUTING signal is present on programmable models (SMP/SMPO)

SENSORS 1-2 – M12 5-PIN FEMALE CONNECTOR (BLUE)

| Pin | Color | Signal | In/Out | Description |
|-----|-------|---------|--------|--------------------|
| 1 | Brown | 24VDC | - | 24VDC power supply |
| 2 | White | SENSOR2 | Input | SENSOR2 status |
| 3 | Blue | 0VDC | - | 0VDC |
| 4 | Black | SENSOR1 | Input | SENSOR1 status |
| 5 | Gray | PE | - | Ground connection |

SENSORS 3-4 – M12 5-PIN FEMALE CONNECTOR (RED)

| Pin | Color | Signal | In/Out | Description |
|-----|-------|---------|--------|--------------------|
| 1 | Brown | 24VDC | - | 24VDC power supply |
| 2 | White | SENSOR4 | Input | SENSOR4 status |
| 3 | Blue | 0VDC | - | 0VDC |
| 4 | Black | SENSOR3 | Input | SENSOR3 status |
| 5 | Gray | PE | - | Ground connection |

USB/MUTING LAMP CONNECTOR

| Pin | Color | SM/SMO Signal (Yellow) | SMP/SMPO Signal (Green) | IN/OUT | Description |
|-----|-------|------------------------|-------------------------|--------|---------------------|
| 1 | Brown | MUT_LAMP | MUT_LAMP | Output | Active muting 24VDC |
| 2 | White | NC | USB+ | In/Out | - |
| 3 | Blue | 0VDC | 0VDC | - | 0VDC |
| 4 | Black | NC | VBUS | Input | 5VDC |
| 5 | Gray | NC | USB- | In/Out | - |

ReeR Safegate Light Curtains – Muting Arms

Features

- Pre-configured and pre-wired muting arms and muting brackets
- MZ series offers five photo beams per sensor, useful for sensing unconventional objects (only one beam on the TRX versions)
- One way (parallel)
- One way (crossed)
- Two way (parallel)
- Two way (crossed)



| ReeR Safegate Light Curtains – Muting Arms Selection Chart | | | | |
|--|----------|---|--|---------------------|
| Part Number | Price | Description | Working Range (m [ft]) | Dimensional Drawing |
| MA-L2X | \$316.00 | Muting arm, sender/receiver pair, 2 crossed beams, one way | 1-2.5 [3.28-8.20] | PDF |
| MA-T2X | \$475.00 | Muting arm, sender/receiver pair, 2 crossed beams, two way | 1-2.5 [3.28-8.20] | PDF |
| MA-L2P-TRX | \$323.00 | Muting arm, active/passive pair, 2 parallel beams, one way | 0-3.5 [0-11.48] | PDF |
| MA-T4P-TRX | \$596.00 | Muting arm, active/passive pair, 4 parallel beams, two way | 0-3.5 [0-11.48] | PDF |
| MZ-T2X | \$499.00 | Bracket with M5, sender/receiver pair, 2 crossed beams, two way | 1-3.5 [3.28-11.48] | PDF |
| MZ-T4P | \$722.00 | Bracket with M5 sender/receiver pair, 4 parallel beams, two way | 0-3.5 [0-11.48] | PDF |
| MZ-L2XP | \$369.00 | Bracket with M5, sender/receiver pair, 2 crossed or parallel beams, one way | 0-3.5 [0-11.48] when parallel 1-3.5 [3.28-11.48] when crossed | PDF |
| MZ-L2XP-TRX | \$370.00 | Bracket with M-TRX, active/passive pair, 2 crossed or parallel beams, one way | 0-3.5 [0-11.48] when parallel 1-3.5 [3.28-11.48] when crossed | PDF |
| MZ-T2X-TRX | \$433.00 | Bracket with M-TRX, active/passive pair, 2 crossed beams, two way | 1-3.5 [3.28-11.48] | PDF |
| MZ-T4P-TRX | \$740.00 | Bracket with M-TRX, active/passive pair, 4 parallel beams, two way | 0-3.5 [0-11.48] | PDF |

ReeR Muting and Automation Photocells

| ReeR Muting and Automation Photocells – Selection Chart | | | | | |
|---|----------|-----------------|----------------------------|--------|---------------------|
| Part Number | Price | Number of Beams | Sensing Range | Coding | Dimensional Drawing |
| Emitter/Receiver Versions | | | | | |
| M5-A | \$165.00 | 5 | 0 to 3.5 m [0 to 11.48 ft] | A | PDF |
| M5-B | \$162.00 | 5 | 0 to 3.5 m [0 to 11.48 ft] | B | PDF |
| Reflector Versions | | | | | |
| M-TRX-A | \$120.00 | 1 | 0 to 5 m [0 to 16.40 ft]* | A | PDF |
| M-TRX-B | \$122.00 | 1 | 0 to 5 m [0 to 16.40 ft]* | B | PDF |



M5-A / M5-B

* Dependent on type of reflector used (see specifications below)

| ReeR Muting and Automation Photocells – Specifications | | | |
|--|--|--|--|
| Model | Micron M5 Emitter | Micron M5 Receiver | M-TRX-A / M-TRX-B |
| Power Supply | 24VDC ± 20% | | |
| Power Consumption at 24VDC | 1W | | 0.2 W |
| Number of Beams | 5 | | 1 |
| Working Range | 0-3.5 m [0 to 11.48 ft] | | 0 to 2.5 m [0 to 8.20 ft] with C3F10 reflector 0 to 3.5 m [0 to 11.48 ft] with C3F8 reflector 0 to 3 m [0 to 9.84 ft] with CD8 reflector |
| Beams Pitch | 10mm [0.39 in] | | NA |
| Immunity to Ambient Light | >10,000 lx (solar) | | NA |
| Emission Angle | ±5° | ±5° | ±5° |
| Emission Wavelength | 940nm (modulated infrared) | - | 660nm (modulated red) |
| Response Time | <10ms | <10ms | 65ms |
| Output | - | PNP 100mA max / dark-on | PNP 100mA max / dark-on |
| Connections | Pigtail 90cm [2.95 ft] with M12 5 pin connector | Pigtail 90cm [2.95 ft] with M12 5 pin connector | Pigtail 90cm [2.95 ft] with M12 5 pin connector |
| MTTF_d | 414.02 years | 414.02 years | 1759.31 years |
| Operating Temperature | -30 to +55°C [-22 to 131°F] (with no condensation) | -30 to +55°C [-22 to 131°F] (with no condensation) | -30 to +55°C [-22 to 131°F] (with no condensation) |
| Protection Degree | IP65 | | |
| Dimensions | Width | 28mm [1.10 in] | 28mm [1.10 in] |
| | Depth | 30mm [1.18 in] | 30mm [1.18 in] |
| | Height | 70mm [2.76 in] | 70mm [2.76 in] |

Emitter

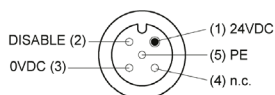

Receiver

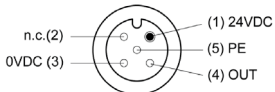

TRX

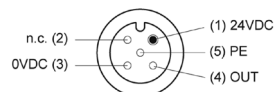

| M5 Emitter | | | | |
|------------|-------|---------|--------------------|---------------|
| Pin | Color | Signal | Description | |
| 1 | Brown | 24VDC | 24VDC power supply | |
| 2 | White | DISABLE | 0VDC=ENABLE | 24VDC=DISABLE |
| 3 | Blue | 0VDC | 0VDC power supply | |
| 4 | Black | NA | Not connected | |
| 5 | Gray | PE | Ground connection | |

| M5 Receiver | | | | |
|-------------|-------|--------|--------------------|-----------------------|
| Pin | Color | Signal | Description | |
| 1 | Brown | 24VDC | 24VDC power supply | |
| 2 | White | NA | Not connected | |
| 3 | Blue | 0VDC | 0VDC power supply | |
| 4 | Black | OUT | 0VDC=Area Free | 24VDC=Area Obstructed |
| 5 | Gray | PE | Ground connection | |

| M TRX | | | | |
|-------|-------|--------|--------------------|-----------------------|
| Pin | Color | Signal | Description | |
| 1 | Brown | 24VDC | 24VDC power supply | |
| 2 | White | NA | Not connected | |
| 3 | Blue | 0VDC | 0VDC power supply | |
| 4 | Black | OUT | 0VDC=Area Free | 24VDC=Area Obstructed |
| 5 | Gray | PE | Ground connection | |

Emitter/Receiver Application

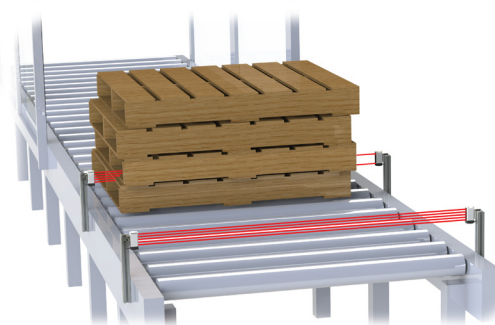

M5 photocells have five beams that are sent out by the emitter. If any one of the five beams is blocked, then the receiver's status signal will change to signify that there is an object in front of the photocell. This is particularly useful when there is a need to detect irregularly shaped items.

ReeR Safegate Light Curtain Accessories

| Safegate Light Curtains Accessories Overview | | | | |
|--|---------|--|--|----------------------------|
| Part Number | Price | Description | Use With | Dimensional Drawing |
| Reflectors | | | | |
| <u>C3F10</u> | \$15.00 | ReeR reflector, rectangular, 30 x 116 mm [1.18 x 4.57 in]. | <u>M-TRX-A</u> or <u>M-TRX-B</u> | <u>PDF</u> |
| <u>C3F8</u> | \$26.50 | ReeR reflector, rectangular, 30 x 78 mm, [1.18 x 3.07 in] with bracket. | <u>M-TRX-A</u> or <u>M-TRX-B</u> | <u>PDF</u> |
| <u>CD8</u> | \$14.50 | ReeR reflector, round, 84mm [3.31 in]. | <u>M-TRX-A</u> or <u>M-TRX-B</u> | <u>PDF</u> |
| Mounting Brackets | | | | |
| <u>SFB-4SG</u> | \$57.00 | ReeR mounting bracket, replacement, standard, zinc plated steel. Package of 4. Mounting hardware included. | ReeR Safegate Light Curtains | <u>PDF</u> |
| <u>SFB-6SG</u> | \$85.00 | ReeR mounting bracket, replacement, standard, zinc plated steel. Package of 6. Mounting hardware included. | ReeR Safegate Light Curtains | <u>PDF</u> |
| Cables | | | | |
| <u>CS12USB</u> | \$45.00 | ReeR programming cable, USB Type A male to 5-pin M12 quick-disconnect, 5-pole, PVC jacket, black, 6.5 ft [2m] cable length. | SMPO models | NA |
| <u>CSY12RX</u> | \$53.00 | ReeR muting receiver cable, 5-pin M12 quick-disconnect to (2) 5-pin M12 quick-disconnects, 5-pole, 24 VDC, PVC jacket, black, 1.3 ft [400mm] cable length, IP67. | ReeR Safegate Light Curtains | NA |
| <u>CSY12TX</u> | \$53.00 | ReeR muting emitter cable, 5-pin M12 quick-disconnect to (2) 5-pin M12 quick-disconnects, 5-pole, 24 VDC, PVC jacket, black, 1.3ft [400mm] cable length, IP67. | ReeR Safegate Light Curtains | NA |



C3F10



SFB-4SG / SFB-6SG



CSY12TX / CSY12RX



C3F8



CD8

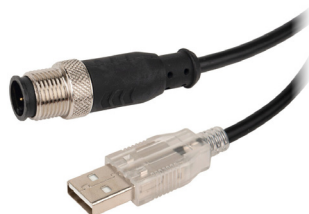

CS12USB

When four M5 muting sensors are installed with a ReeR Safegate light curtain, **CSY12TX** and **CSY12RX** Y-splitters will be required.

Pinouts

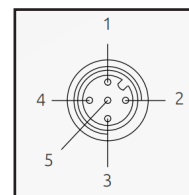
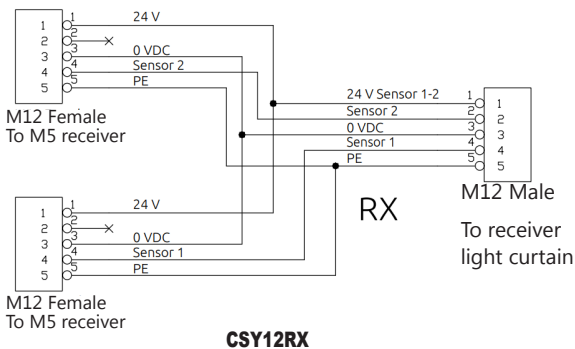
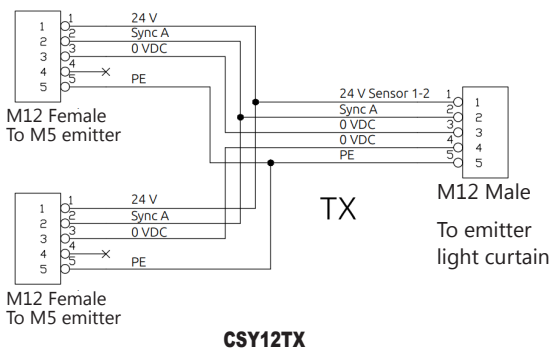

ReeR Safegate Light Curtain Accessories

| Safegate Light Curtains Accessories Overview | | | | |
|--|----------|--|--|---------------------|
| Part Number | Price | Description | Use With | Dimensional Drawing |
| Protective Columns* | | | | |
| <u>FMC-SGB3</u> | \$191.00 | ReeR protective column, 1200mm housing. | SMO-3B SMPO-3B SMO-3B-TRX SMPO-3B-TRX S-3B S-3B-TRX | PDF |
| <u>FMC-SGB4</u> | \$203.00 | ReeR protective column, 1330mm housing. | SMO-4B SMPO-4B SMO-4B-TRX SMPO-4B-TRX S-4B S-4B-TRX | PDF |
| Mirror Columns* | | | | |
| <u>FMC-S3</u> | \$226.00 | ReeR single mirror column, 1200mm housing, 1198mm mirror(s). | SMO-3B SMPO-3B SMO-3B-TRX SMPO-3B-TRX S-3B S-3B-TRX | PDF |
| <u>FMC-S4</u> | \$245.00 | ReeR single mirror column, 1330mm housing, 1328mm mirror(s). | SMO-4B SMPO-4B SMO-4B-TRX SMPO-4B-TRX S-4B S-4B-TRX | PDF |
| <u>FMC-SB3</u> | \$456.00 | ReeR three mirror column, 1200mm housing, (3) 150mm mirror(s). | SMO-3B SMPO-3B SMO-3B-TRX SMPO-3B-TRX S-3B S-3B-TRX | PDF |
| <u>FMC-SB4</u> | \$525.00 | ReeR four mirror column, 1330mm housing, (4) 150mm mirror(s). | SMO-4B SMPO-4B SMO-4B-TRX SMPO-4B-TRX S-4B S-4B-TRX | PDF |
| Column Base | | | | |
| <u>FMC-CB</u> | \$141.00 | ReeR column base, 202 x 224 x 55 mm housing. Mounting hardware included. | FMC-Sx | PDF |
| <u>FMC-CBL</u> | \$57.00 | ReeR column base, 202 x 224 x 37 mm housing. Mounting hardware included. | FMC-Sx | PDF |

* Column base must be purchased separately



FMC-SGB3 / FMC-SGB4

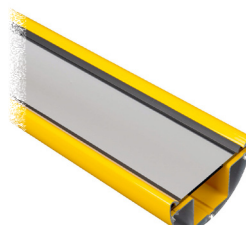

FMC-S3 / FMC-S4

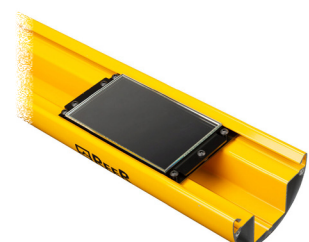

FMC-SB3 / FMC-SB4



FMC-CB





FMC-CBL

ReeR Safegate Light Curtains – Body Protection

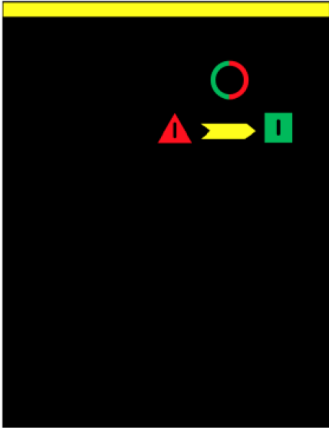
Emitter (non TRX models) LED Functions



| TRI-COLOR LED | | | |
|--|---|--|-------------------------|
| RED  | YELLOW  | GREEN  | MEANING |
| On | - | - | Power on - Initial Test |
| Flashing | - | - | Fail condition |
| - | On | - | Curtain under test |
| - | - | On | Normal operation |

Fault Diagnostics (non TRX models)

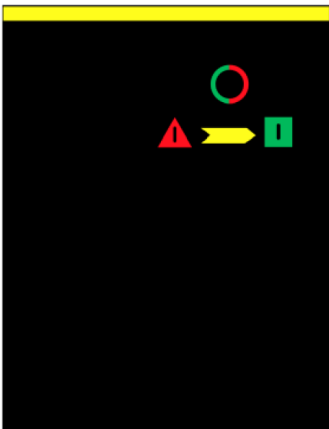

| NUMBER OF FLASHES | ERROR | POSSIBLE CAUSE |
|---|----------------------------------|---|
| RED  | <i>POSSIBLE CAUSE</i> | <i>POSSIBLE CAUSE</i> |
| 2 | RANGE0 / RANGE1 incorrect wiring | Check pin 2 and 4 connections on the main connector |
| 3/4 | Internal error | Contact tech support |
| 5 | SYNC incorrect wiring | Check pin 2 connection on the sensors connectors |

ReeR Safegate Light Curtains – Body Protection

Receiver/Active (All Models) – LED Functions



| LED | | | | | | | MEANING | |
|---------------|-------------------------|--------|--------------|--------|-----------------|--------|---------|--|
| PRG ● | ● COM | ● CLR | ● OVR | S 1 ● | S 2 ● | S 3 ● | | S 4 ● |
| Blue | | | | | | | | Curtain programmed via USB |
| | Orange | | | | | | | Communication with active PC |
| | Blue | | | | | | | Weak signal (TRXmodels only) |
| | Alternating Blue/Orange | | | | | | | Weak signal (TRXmodels only) |
| | | Yellow | | | | | | Curtain awaiting RESTART (clear gate) |
| | | | Green | | | | | Normal operation (clear gate) |
| | | | Red | | | | | Occupied gate |
| | | | Red flashing | | | | | Detected failure (Refer to "Troubleshooting" section in User's Manual) |
| | | | | Yellow | | | | Muting active |
| | | | | | Yellow | | | Override active |
| | | | | | Yellow flashing | | | Override request |
| | | | | | | Yellow | | Sensor interrupted |
| Blue flashing | Orange flashing | | | | | | | No barrier configuration |
| Blue flashing | Orange flashing | | Red flashing | | | | | Detected double configuration (hardware and software) – SMPO only |

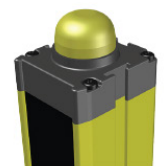
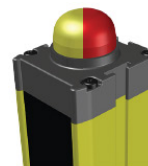
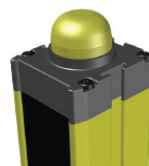

BREAK
Occupied curtain with at least one occupied beam

FAIL
Curtain in error condition

CLEAR
Curtain awaiting RESTART

GUARD
Normal operation condition

MUTING
Muting underway

OVERRIDE
(Request)

OVERRIDE
(In progress)

| LIGHT | MEANING |
|-----------------|---------------------------------------|
| Yellow/Green | Curtain awaiting RESTART (gate clear) |
| Green | Normal operation (gate clear) |
| Red | Occupied gate |
| Red Flashing | Detected failure (see DIAGNOSTICS) |
| Yellow | Muting active |
| Yellow Flashing | Override active |
| Yellow/Red | Override request |

ReeR Safegate Light Curtains – Body Protection

Fault Diagnostics

NOTE regarding SMP and SMPO models: In addition to the corresponding LED indication, when the operator connects SAFEGATE to a computer via USB, a pop-up window with the error code appears on the monitor.



| | LED | | | | ERROR | POSSIBLE CAUSE |
|---|-----|-----|-----|-----------|--|--|
| | | CLR | MUT | OVR | | |
| | | | | | | |
| 2 | | | | | Configuration error SEL_A/SEL_B/EDM | Pin 6-8-11 connections on the RX male connector |
| 2 | | | | 2 (S1/S2) | Inconsistency between red and blue connector selection for S2 wiring and the physical wiring of S2 | Wire S2 with the selected wiring option (red or blue connector) |
| 3 | | | | | Wrong EDM configuration | Pin 8 connections on the RX male connector |
| 3 | 3 | | | | EDM feed back failure | Contact connectors EDM Power Contactors |
| 3 | | 3 | | | STATUS input failure | Pin 12 connections on the RX male connector |
| 3 | | | 3 | | Override1 / Override2 input failure | Pin connections 9-10 on the male connector on the RX |
| 3 | | | | 3 | Sensor input failure | Pin connections 2-4 on the sensor connectors |
| 3 | 3 | 3 | 3 | | MUTING LAMP FAILURE | Connections on the auxiliary lamp connector |
| 4 | | | | | OSSD1 / OSSD2 error | 3-4 pin connectors on the male connector on the RX |
| 5 | | | | | MAIN CARD ERROR | Contact tech support |
| 5 | 5 | | | | MAIN CARD (EEPROM) error | Contact tech support |
| 5 | | | 5 | | MAIN CARD ERROR | Contact tech support |
| 6 | | | | | MAIN CARD (Microcontroller) error | Contact tech support |
| 6 | 6 | | | | Generic Default Board Error | 6-7-8-9-10-11 pin connections on the male connector on the RX |
| 6 | | 6 | | | Beam error | Contact tech support |
| 6 | | | 6 | | 24VDC power supply overload | Eventual short-circuit on OSSD outputs |
| 6 | | 6 | 6 | | LAMP/STATUS over current | Short circuit on pin 12 or auxiliary lamp connector |
| 7 | | | | | Receiving beams failure | Contact tech support |
| 8 | | | | | Interfering Emitter Detected | Verify the presence of another curtain not correctly positioned. Refer to "Multiple Systems" section of User's Manual. |

Safety Products



Warning: Safety products sold by AutomationDirect are Safety components only. The purchaser/installer is solely responsible for the application of these components and ensuring all necessary steps have been taken to assure each application and use meets all performance and applicable safety requirements and/or local, national and/or international safety codes as required by the application. AutomationDirect cannot certify that our products, used solely or in conjunction with other AutomationDirect or other vendors' products, will assure safety for any application. Any person using or applying any products sold by AutomationDirect is responsible for learning the safety requirements for their individual application and applying them, and therefore assumes all risks, and accepts full and complete responsibility, for the selection and suitability of the product for their respective application.

AutomationDirect does not provide design or consulting services, and cannot advise whether any specific application or use of our products would ensure compliance with the safety requirements for any application.