

ReeR Safegate Light Curtains – Body Protection

Safegate Type 4 access control barriers provide the ideal solution for protection in a wide range of high-risk industrial applications, in particular those requiring a high level of integration of the muting functions. Safegate greatly simplifies seamless integration of muting sensors with light curtain access control barriers

**Hardware configuration
with integrated status and muting lamp**

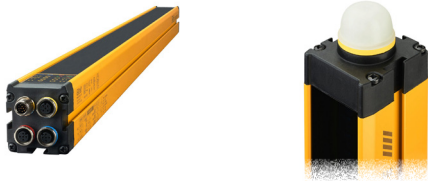

SMO-3B, SMO-4B, SMO-3B-TRX, SMO-4B-TRX

**Hardware or software configuration with
integrated status and muting lamp**



SMPO-3B, SMPO-4B, SMPO-3B-TRX, SMPO-4B-TRX

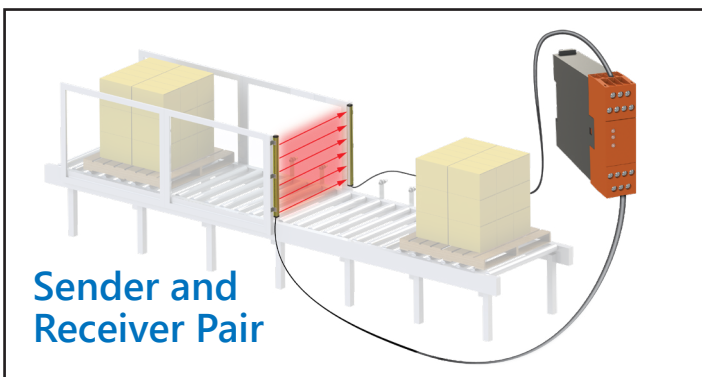

SMO-3B, SMO-4B, SMPO-3B, SMPO-4B

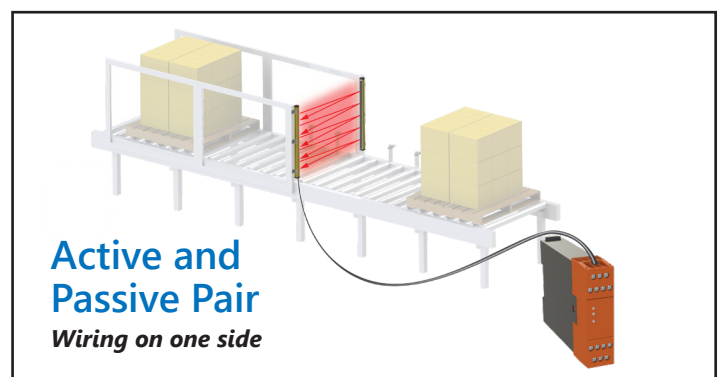

SMO-3B-TRX, SMO-4B-TRX, SMPO-3B-TRX, SMPO-4B-TRX

One way (2 sensor) crossed

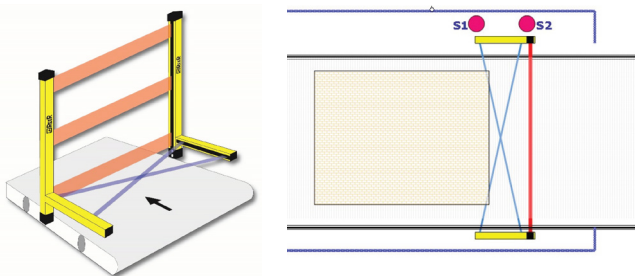

MA-L2X, MZ-L2XP, MZ-L2XP-TRX

One way (2 sensor) parallel

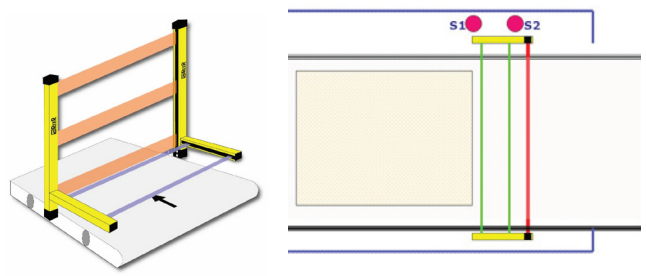

MA-L2P-TRX, MZ-L2XP, MZ-L2XP-TRX

Two way (2 sensor) crossed

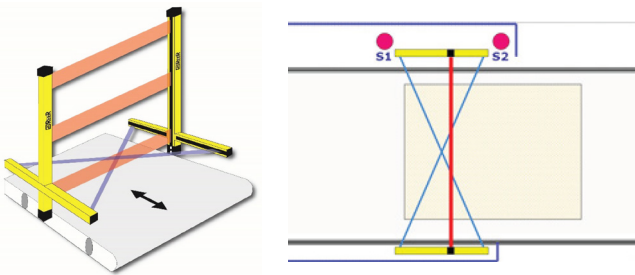

MA-T2X, MZ-T2X, MZ-T2X-TRX

Two way (4 sensor) parallel

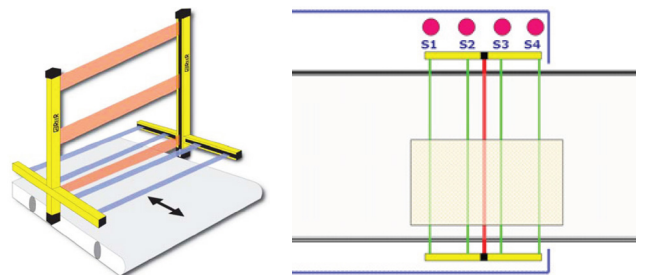

MA-T4P-TRX, MZ-T4P, MZ-T4P-TRX

ReeR Safegate Light Curtains – Body Protection

With Muting Arm/Brackets

Muting Arms:
[MA-L2X](#)
[MA-T2X](#)
[MA-L2P-TRX](#)
[MA-T4P-TRX](#)
 or
Muting Brackets:
[MZ-L2XP](#)
[MZ-T2X](#)
[MZ-T4P](#)
[MZ-L2XP-TRX](#)
[MZ-T2X-TRX](#)
[MZ-T4P-TRX](#)

Cable
 M12 12-pin cable
 (See recommended items for cabling)

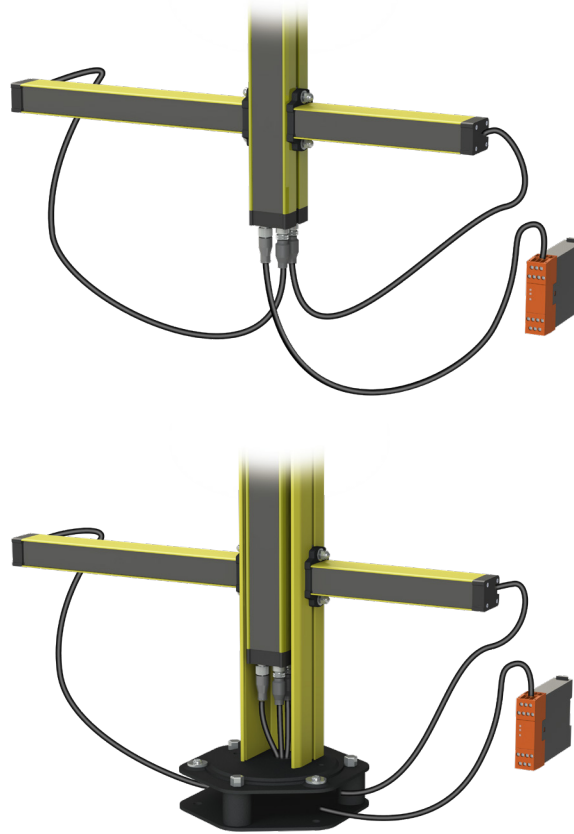

Light Curtains:
[SMO-3B](#)
[SMO-4B](#)
[SMPO-3B](#)
[SMPO-4B](#)
[SMO-3B-TRX](#)
[SMO-4B-TRX](#)
[SMPO-3B-TRX](#)
[SMPO-4B-TRX](#)
 If a TRX light curtain is selected, then the muting arms/brackets part number should end in TRX as well.

Protective Columns (optional)
[FMC-SGB3](#) (for SMxO-3B or SMxO-3B-TRX)
[FMC-SGB4](#) (for SMxO-4B or SMxO-4B-TRX)
Protective Column Base:
 (Required with Protective Column)
[FMC-CB](#) (shown)
 or
[FMC-CBL](#) (not shown)

With Muting Photocells

Photo Cells
[M5-A](#)
[M5-B](#)
[M-TRX-A](#)
[M-TRX-B](#)

Y-Splitters
[CSY12TX](#)
[CSY12RX](#)

Cable
 M12 12-pin cable
 (See recommended items for cabling)

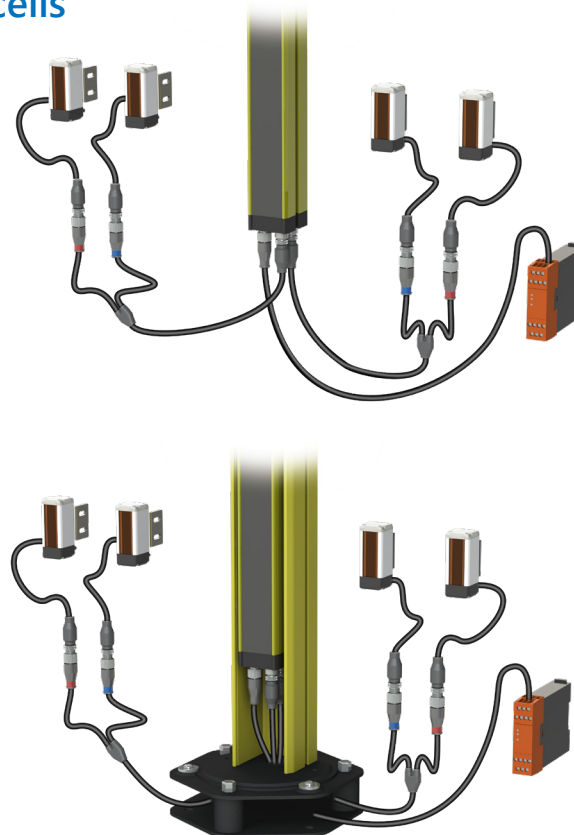

Light Curtain:
[SMO-3B](#)
[SMO-4B](#)
[SMPO-3B](#)
[SMPO-4B](#)
[SMO-3B-TRX](#)
[SMO-4B-TRX](#)
[SMPO-3B-TRX](#)
[SMPO-4B-TRX](#)
 If a TRX light curtain is selected, then the muting arms/brackets part number should end in TRX as well.

Protective Columns (optional)
[FMC-SGB3](#) (for SMxO-3B or SMxO-3B-TRX)
[FMC-SGB4](#) (for SMxO-4B or SMxO-4B-TRX)
Protective Column Base:
 (Required with Protective Column)
[FMC-CB](#) (shown)
 or
[FMC-CBL](#) (not shown)

ReeR Safegate Light Curtains – Body Protection



Features

- Integrated muting functions
- Pre-configured and pre-wired muting arms and muting brackets (sold separately)
- Hardware or software configuration options
- Bright LED status and muting lamp
- Status display on unit
- Fully scalable
- Passive retro-reflective elements available (TRX)

Benefits of Software Configurable Models (SMPO-xxx)

- Upload/download settings
- Specify muting parameters
- Utilize up to two partial muting configurations
- Check and validate programmable configuration
- Light curtain status and monitoring
- Free configuration software

ReeR Safegate Light Curtains – Body Protection With Muting Functions – Selection Chart												
Part Number	Price	Protective Height Hs mm [in]	Housing Height Hb mm [in]	Total Height Ht mm [in]	Number of Beams	PFHd	Response Time [ms]	MTTFd [years]	DCavg	Weight kg [lb]	Resolution mm [in]	Dimensional Drawing
Sender and Receiver Pair												
<i>Hardware configuration with integrated status and muting LED</i>												
SMO-3B	\$985.00	810 [31.89]	974 [38.33]	1010 [39.76]	3	9.63E-09	5.5	262.4	98.5%	6.08 [13.40]	400 [15.75]	PDF
SMO-4B	\$1,058.00	910 [35.83]	1073 [42.24]	1110 [43.70]	4	1.03E-08	5.5	253.3	98.4%	6.56 [14.46]	300 [11.81]	PDF
<i>Hardware or software configuration with integrated status and muting LED</i>												
SMPO-3B	\$1,006.00	810 [31.89]	974 [38.33]	1010 [39.76]	3	9.63E-09	5.5	262.4	98.5%	6.08 [13.40]	400 [15.75]	PDF
SMPO-4B	\$1,150.00	910 [35.83]	1073 [42.24]	1110 [43.70]	4	1.03E-08	5.5	253.3	98.4%	6.56 [14.46]	300 [11.81]	PDF
Active and Passive Pair												
<i>Hardware configuration with integrated status and muting LED</i>												
SMO-3B-TRX	\$985.00	810 [31.89]	935 [36.79]	970 [38.19]	3	7.58E-09	5.5	401.0	98.2%	5.98 [13.18]	400 [15.75]	PDF
SMO-4B-TRX	\$1,058.00	910 [35.83]	1035 [40.73]	1070 [42.13]	4	7.68E-09	5.5	399.4	99.2%	6.54 [14.42]	300 [11.81]	PDF
<i>Hardware or software configuration with integrated status and muting LED</i>												
SMPO-3B-TRX	\$1,006.00	810 [31.89]	935 [36.79]	970 [38.19]	3	7.58E-09	5.5	401.0	98.2%	5.98 [13.18]	400 [15.75]	PDF
SMPO-4B-TRX	\$1,150.00	910 [35.83]	1035 [40.73]	1070 [42.13]	4	7.68E-09	5.5	399.4	99.2%	6.54 [14.42]	300 [11.81]	PDF

Note: SMO and SMPO are designed to work with integrated muting arms, brackets, or photocells and do not work as stand-alone access barriers.

Dimensions (see table above)

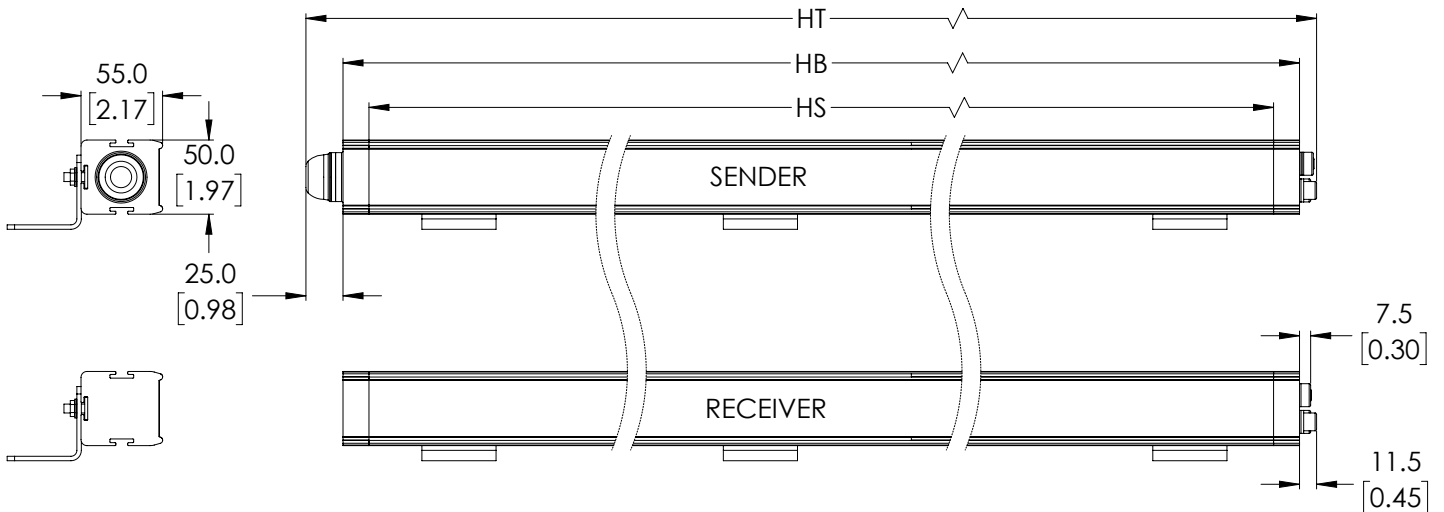

ReeR Safegate Light Curtains – Body Protection

ReeR Safegate Light Curtains – Body Protection With Muting Functions – Specifications					
		Sender and Receiver Pair		Active and Passive Pair	
		SMO-3B, SMO-4B	SMPO-3B, SMPO-4B	SMO-3B-TRX, SMO-4B-TRX	SMPO-3B-TRX, SMPO-4B-TRX
Supply Voltage		24VDC ±20%		24VDC ±20%	
Safety Outputs (OSSDs)		2 PNP – 400mA @ 24VDC		2 PNP – 400mA @ 24VDC	
Status Outputs		1 PNP – 100mA @ 24VDC		1 PNP – 100mA @ 24VDC	
Operating Temperature		-30°C to 55°C [-22°F to 131°F]		-30°C to 55°C [-22°F to 131°F]	
LED Status Lamp		LED indication of Muting and Curtain Status on RX Curtain	LED indication of Muting, Curtain Status, and Override on RX Curtain	LED indication of Muting and Curtain Status on Active Curtain	LED indication of Muting, Curtain Status, and Override on Receiver Curtain
Safety Category	Type 4	EN 61496-1:2013 IEC 61496-2:2013		EN 61496-1:2013 IEC 61496-2:2013	
	SIL3	IEC 61508-1: (ed.2) IEC 61508-2: (ed.2) IEC 61508-3: (ed.2) IEC 61508-4: (ed.2)		IEC 61508-1: (ed.2) IEC 61508-2: (ed.2) IEC 61508-3: (ed.2) IEC 61508-4: (ed.2)	
	PLe	EN ISO 13849-1:2015		EN ISO 13849-1:2015	
	CAT4	EN ISO 13849-1:2015		EN ISO 13849-1:2015	
CCF		80%		80%	
Degree of Protection		IP65 and IP67		IP65 and IP67	
Working Range		0-4 m [0-13.12 ft] low 0-12 m [0-39.37 ft] high (See Range/Test Selection Chart on next page)		0-8 m [0-26.25 ft]	
Power Consumption		Transmitter: 1W; Receiver: 2W		3W	
Connections		Power on TX: M12 5-pin male Power on RX: M12 12-pin male Muting sensor connectors/muting lamp/configuration: Two M12 5-pin female		Power on Active: M12 12-pin male Muting sensor connectors/muting lamp/configuration: Two M12 5-pin female	
EDM Input		Available on RX, selectable		Available on Active, selectable	
Restart Auto/Manual		Available on RX, selectable		Available on Active, selectable	
Test Input		Available on TX, selectable		Not available	
Configuration		Hardware on RX connector	Hardware or software with USB	Hardware on active element connector	Hardware or software with USB
Conductor requirements		20AWG if length is less than 50m [164.04 ft] 17AWG if length is between 50m [164.04 ft] and 100m [328.1 ft]		20AWG if length is less than 50m [164.04 ft] 17AWG if length is between 50m [164.04 ft] and 100m [328.1 ft]	
Max Connection Length		100m [328.1 ft]		100m [328.1 ft]	
Current Rating Available for Muting Sensors		50mA		50mA	
Muting Lamp Output		24VDC, 0.5 to 5 W		24VDC, 0.5 to 5 W	
Muting Signal Response Time (Sensors)		100ms		100ms	
Muting Signal Logic Levels (Sensors)		<5VDC: Clear Sensor 11-30 VDC: Actuated Sensor		<5VDC: Clear Sensor 11-30 VDC: Actuated Sensor	
Time Out Muting		30s 9h (non-sequential) Can be excluded (sequential)	Configurable via software	30s 9h (non-sequential) Can be excluded (sequential)	Configurable via software
Muting Override		Selectable by pulse or by action maintained	Selectable by pulse or by action maintained; configurable via software	Selectable by pulse or by action maintained	Selectable by pulse or by action maintained; configurable via software
Override Max Timeout		15m (renewable)	15m (renewable) software configurable	15m (renewable)	15m (renewable) software configurable
Maximum Number of Consecutive Overrides		30		30	
Muting Logic		Crossed beams or sequential	Fully configurable with ReeR software	Crossed beams or sequential	Fully configurable with ReeR software
Partial Muting		NA	Possibility to interrupt only a selected number of beams	NA	Possibility to interrupt only a selected number of beams
Tolerance Time Between Sensors 1 and 2		4s	2 to 5 s Configurable via software	4s	2 to 5 s Configurable via software
Muting Enable		Pin on main connector, disabled if not required and monitored		Pin on main connector, disabled if not required and monitored	

ReeR Safegate Light Curtains – Body Protection

Pin outs for SMO-3B, SMO-4B, SMPO-3B and SMPO-4B

Sender

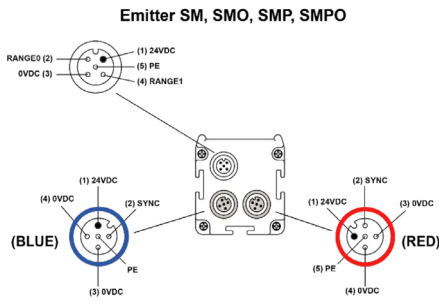

Receiver

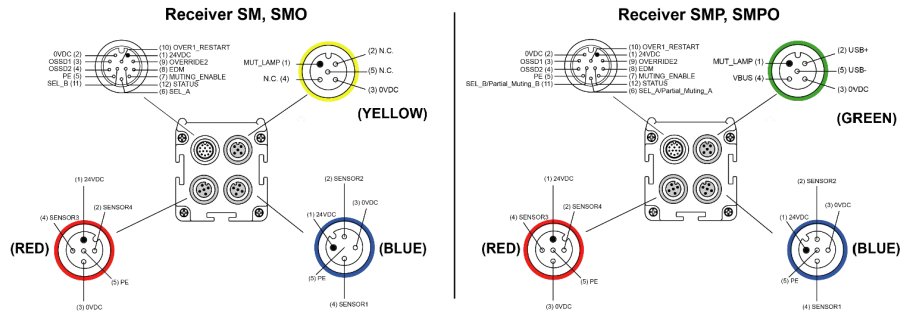

RANGE SELECTION / TEST M12 5 PIN MALE CONNECTOR				
Pin	Color	Signal	In/Out	Description
1	Brown	24VDC	-	24VDC power supply
2	White	RANGE0	Input	Range/Test selection (see chart below)
3	Blue	0VDC	-	0VDC power supply
4	Black	RANGE1	Input	Range/Test selection (see chart below)
5	Gray	PE	-	Ground connection

RANGE / TEST SELECTION		
Pin 2	Pin 4	Function
24DC	0VDC	LOW range
0VDC	24DC	HIGH range
0VDC	0VDC	SAFEGATE in TEST mode
24VDC	24DC	Not allowed

SENSORS 1-2 M12 5-PIN FEMALE CONNECTOR (BLUE)				
Pin	Color	Signal	In/Out	Description
1	Brown	24VDC	-	24VDC sensors power supply
2	White	SYNC	Output	M5 arms synchronisation
3	Blue	0VDC	-	0VDC
4	Black	0VDC	-	0VDC
5	Gray	PE	-	Ground connection

SENSORS 3-4 M12 5-PIN FEMALE CONNECTOR (RED)				
Pin	Color	Signal	In/Out	Description
1	Brown	24VDC	-	24VDC sensors power supply
2	White	SYNC	Output	M5 arms synchronisation
3	Blue	0VDC	-	0VDC
4	Black	0VDC	-	0VDC
5	Gray	PE	-	Ground connection

PRIMARY M12 12-PIN MALE CONNECTOR				
Pin	Color	Signal	In/Out	Description
1	Brown	24VDC	-	24VDC power supply
2	Blue	0VDC	-	0VDC power supply
3	White	OSSD1	Output	Safety static outputs
4	Green	OSSD2	Output	
5	Pink	PE	-	Ground connection
6	Yellow	SEL_A	Input	Muting configuration
		PARTIAL_MUTING_A (see note)		Partial muting control
7	Black	MUT_ENABLE	Input	External muting enable
8	Gray	EDM	Input	K1/K2 feedback
9	Red	VERRIDE2	Input	Override request
		VERRIDE1		Override request
10	Purple	RESTART	Input	Restart interlock
		SEL_B		Muting configuration
		PARTIAL_MUTING_B (see note)		Partial muting control
11	Grey/Pink	STATUS	Input	System status
12	Red/Blue	STATUS	Output	System status

NOTE: PARTIAL_MUTING signal is present on programmable models (SMP/SMPO)

SENSORS 1-2 – M12 5-PIN FEMALE CONNECTOR (BLUE)				
Pin	Color	Signal	In/Out	Description
1	Brown	24VDC	-	24VDC power supply
2	White	SENSOR2	Input	SENSOR2 status
3	Blue	0VDC	-	0VDC
4	Black	SENSOR1	Input	SENSOR1 status
5	Gray	PE	-	Ground connection

SENSORS 3-4 – M12 5-PIN FEMALE CONNECTOR (RED)				
Pin	Color	Signal	In/Out	Description
1	Brown	24VDC	-	24VDC power supply
2	White	SENSOR4	Input	SENSOR4 status
3	Blue	0VDC	-	0VDC
4	Black	SENSOR3	Input	SENSOR3 status
5	Gray	PE	-	Ground connection

USB/MUTING LAMP CONNECTOR					
Pin	Color	SMO Signal (Yellow)	SMPO Signal (Green)	IN/OUT	Description
1	Brown	MUT_LAMP	MUT_LAMP	Output	Active muting 24VDC
2	White	NC	USB+	In/Out	-
3	Blue	0VDC	0VDC	-	0VDC
4	Black	NC	VBUS	Input	5VDC
5	Gray	NC	USB-	In/Out	-

ReeR Safegate Light Curtains – Muting Arms

Features

- Pre-configured and pre-wired muting arms and muting brackets
- MZ series offers five photo beams per sensor, useful for sensing unconventional objects (only one beam on the TRX versions)
- One way (parallel)
- One way (crossed)
- Two way (parallel)
- Two way (crossed)



ReeR Safegate Light Curtains – Muting Arms Selection Chart

Part Number	Price	Description	Working Range (m [ft])	Dimensional Drawing
MA-L2X	\$316.00	Muting arm, sender/receiver pair, 2 crossed beams, one way	1-2.5 [3.28-8.20]	PDF
MA-T2X	\$475.00	Muting arm, sender/receiver pair, 2 crossed beams, two way	1-2.5 [3.28-8.20]	PDF
MA-L2P-TRX	\$323.00	Muting arm, active/passive pair, 2 parallel beams, one way	0-3.5 [0-11.48]	PDF
MA-T4P-TRX	\$596.00	Muting arm, active/passive pair, 4 parallel beams, two way	0-3.5 [0-11.48]	PDF
MZ-T2X	\$499.00	Bracket with M5, sender/receiver pair, 2 crossed beams, two way	1-3.5 [3.28-11.48]	PDF
MZ-T4P	\$722.00	Bracket with M5 sender/receiver pair, 4 parallel beams, two way	0-3.5 [0-11.48]	PDF
MZ-L2XP	\$369.00	Bracket with M5, sender/receiver pair, 2 crossed or parallel beams, one way	0-3.5 [0-11.48] when parallel 1-3.5 [3.28-11.48] when crossed	PDF
MZ-L2XP-TRX	\$370.00	Bracket with M-TRX, active/passive pair, 2 crossed or parallel beams, one way	0-3.5 [0-11.48] when parallel 1-3.5 [3.28-11.48] when crossed	PDF
MZ-T2X-TRX	\$433.00	Bracket with M-TRX, active/passive pair, 2 crossed beams, two way	1-3.5 [3.28-11.48]	PDF
MZ-T4P-TRX	\$740.00	Bracket with M-TRX, active/passive pair, 4 parallel beams, two way	0-3.5 [0-11.48]	PDF

ReeR Muting and Automation Photocells

ReeR Muting and Automation Photocells – Selection Chart					
Part Number	Price	Number of Beams	Sensing Range	Coding	Dimensional Drawing
Emitter/Receiver Versions					
M5-A	\$165.00	5	0 to 3.5 m [0 to 11.48 ft]	A	PDF
M5-B	\$162.00	5	0 to 3.5 m [0 to 11.48 ft]	B	PDF
Reflector Versions					
M-TRX-A	\$120.00	1	0 to 5 m [0 to 16.40 ft]*	A	PDF
M-TRX-B	\$122.00	1	0 to 5 m [0 to 16.40 ft]*	B	PDF



M5-A / M5-B

* Dependent on type of reflector used (see specifications below)

ReeR Muting and Automation Photocells – Specifications			
Model	Micron M5 Emitter	Micron M5 Receiver	M-TRX-A / M-TRX-B
Power Supply	24VDC ± 20%		
Power Consumption at 24VDC	1W		0.2 W
Number of Beams	5		1
Working Range	0-3.5 m [0 to 11.48 ft]		0 to 2.5 m [0 to 8.20 ft] with C3F10 reflector 0 to 3.5 m [0 to 11.48 ft] with C3F8 reflector 0 to 3 m [0 to 9.84 ft] with CD8 reflector
Beams Pitch	10mm [0.39 in]		NA
Immunity to Ambient Light	>10,000 lx (solar)		NA
Emission Angle	±5°	±5°	±5°
Emission Wavelength	940nm (modulated infrared)	-	660nm (modulated red)
Response Time	<10ms	<10ms	65ms
Output	-	PNP 100mA max / dark-on	PNP 100mA max / dark-on
Connections	Pigtail 90cm [2.95 ft] with M12 5 pin connector	Pigtail 90cm [2.95 ft] with M12 5 pin connector	Pigtail 90cm [2.95 ft] with M12 5 pin connector
MTTF_d	414.02 years	414.02 years	1759.31 years
Operating Temperature	-30 to +55°C [-22 to 131°F] (with no condensation)	-30 to +55°C [-22 to 131°F] (with no condensation)	-30 to +55°C [-22 to 131°F] (with no condensation)
Protection Degree	IP65		
Dimensions	Width	28mm [1.10 in]	28mm [1.10 in]
	Depth	30mm [1.18 in]	30mm [1.18 in]
	Height	70mm [2.76 in]	70mm [2.76 in]

Emitter

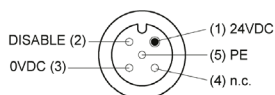

Receiver

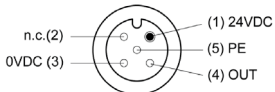

TRX

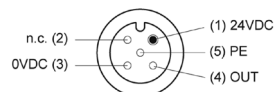

M5 Emitter				
Pin	Color	Signal	Description	
1	Brown	24VDC	24VDC power supply	
2	White	DISABLE	0VDC=ENABLE	24VDC=DISABLE
3	Blue	0VDC	0VDC power supply	
4	Black	NA	Not connected	
5	Gray	PE	Ground connection	

M5 Receiver				
Pin	Color	Signal	Description	
1	Brown	24VDC	24VDC power supply	
2	White	NA	Not connected	
3	Blue	0VDC	0VDC power supply	
4	Black	OUT	0VDC=Area Free	24VDC=Area Obstructed
5	Gray	PE	Ground connection	

M TRX				
Pin	Color	Signal	Description	
1	Brown	24VDC	24VDC power supply	
2	White	NA	Not connected	
3	Blue	0VDC	0VDC power supply	
4	Black	OUT	0VDC=Area Free	24VDC=Area Obstructed
5	Gray	PE	Ground connection	

Emitter/Receiver Application

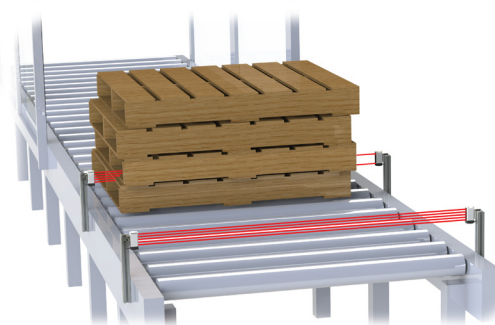

M5 photocells have five beams that are sent out by the emitter. If any one of the five beams is blocked, then the receiver's status signal will change to signify that there is an object in front of the photocell. This is particularly useful when there is a need to detect irregularly shaped items.

ReeR Safegate Light Curtain Accessories

Safegate Light Curtains Accessories Overview				
Part Number	Price	Description	Use With	Dimensional Drawing
Reflectors				
<u>C3F10</u>	\$15.00	ReeR reflector, rectangular, 30 x 116 mm [1.18 x 4.57 in].	<u>M-TRX-A</u> or <u>M-TRX-B</u>	<u>PDF</u>
<u>C3F8</u>	\$26.50	ReeR reflector, rectangular, 30 x 78 mm, [1.18 x 3.07 in] with bracket.	<u>M-TRX-A</u> or <u>M-TRX-B</u>	<u>PDF</u>
<u>CD8</u>	\$14.50	ReeR reflector, round, 84mm [3.31 in].	<u>M-TRX-A</u> or <u>M-TRX-B</u>	<u>PDF</u>
Mounting Brackets				
<u>SFB-4SG</u>	\$57.00	ReeR mounting bracket, replacement, standard, zinc plated steel. Package of 4. Mounting hardware included.	ReeR Safegate Light Curtains	<u>PDF</u>
<u>SFB-6SG</u>	\$85.00	ReeR mounting bracket, replacement, standard, zinc plated steel. Package of 6. Mounting hardware included.	ReeR Safegate Light Curtains	<u>PDF</u>
Cables				
<u>CS12USB</u>	\$45.00	ReeR programming cable, USB Type A male to 5-pin M12 quick-disconnect, 5-pole, PVC jacket, black, 6.5 ft [2m] cable length.	SMPO models	NA
<u>CSY12RX</u>	\$53.00	ReeR muting receiver cable, 5-pin M12 quick-disconnect to (2) 5-pin M12 quick-disconnects, 5-pole, 24 VDC, PVC jacket, black, 1.3 ft [400mm] cable length, IP67.	ReeR Safegate Light Curtains	NA
<u>CSY12TX</u>	\$53.00	ReeR muting emitter cable, 5-pin M12 quick-disconnect to (2) 5-pin M12 quick-disconnects, 5-pole, 24 VDC, PVC jacket, black, 1.3ft [400mm] cable length, IP67.	ReeR Safegate Light Curtains	NA

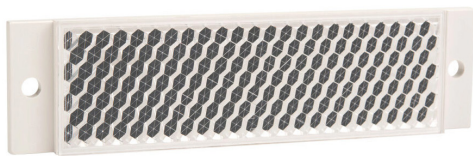

C3F10



SFB-4SG / SFB-6SG



CSY12TX / CSY12RX



C3F8



CD8

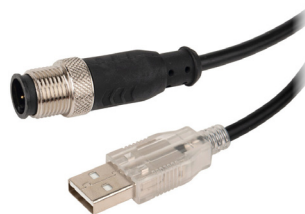

CS12USB

When four M5 muting sensors are installed with a ReeR Safegate light curtain, CSY12TX and CSY12RX Y-splitters will be required.

Pinouts

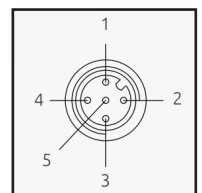
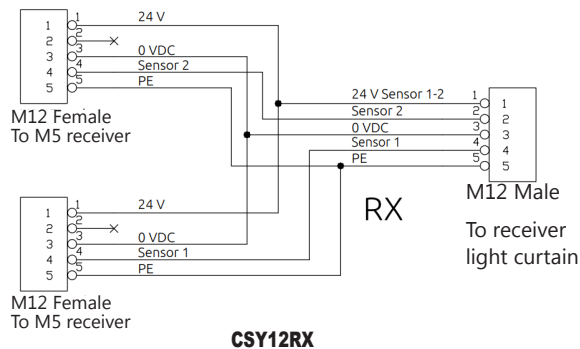
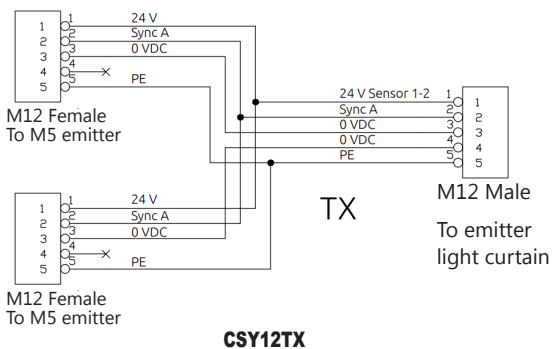

ReeR Safegate Light Curtain Accessories

Safegate Light Curtains Accessories Overview				
Part Number	Price	Description	Use With	Dimensional Drawing
Protective Columns*				
<u>FMC-SGB3</u>	\$191.00	ReeR protective column, 1200mm housing.	SMO-3B SMPO-3B SMO-3B-TRX SMPO-3B-TRX S-3B S-3B-TRX	PDF
<u>FMC-SGB4</u>	\$203.00	ReeR protective column, 1330mm housing.	SMO-4B SMPO-4B SMO-4B-TRX SMPO-4B-TRX S-4B S-4B-TRX	PDF
Mirror Columns*				
<u>FMC-S3</u>	\$226.00	ReeR single mirror column, 1200mm housing, 1198mm mirror(s).	SMO-3B SMPO-3B SMO-3B-TRX SMPO-3B-TRX S-3B S-3B-TRX	PDF
<u>FMC-S4</u>	\$245.00	ReeR single mirror column, 1330mm housing, 1328mm mirror(s).	SMO-4B SMPO-4B SMO-4B-TRX SMPO-4B-TRX S-4B S-4B-TRX	PDF
<u>FMC-SB3</u>	\$456.00	ReeR three mirror column, 1200mm housing, (3) 150mm mirror(s).	SMO-3B SMPO-3B SMO-3B-TRX SMPO-3B-TRX S-3B S-3B-TRX	PDF
<u>FMC-SB4</u>	\$525.00	ReeR four mirror column, 1330mm housing, (4) 150mm mirror(s).	SMO-4B SMPO-4B SMO-4B-TRX SMPO-4B-TRX S-4B S-4B-TRX	PDF
Column Base				
<u>FMC-CB</u>	\$141.00	ReeR column base, 202 x 224 x 55 mm housing. Mounting hardware included.	FMC-Sx	PDF
<u>FMC-CBL</u>	\$57.00	ReeR column base, 202 x 224 x 37 mm housing. Mounting hardware included.	FMC-Sx	PDF

* Column base must be purchased separately



FMC-SGB3 / FMC-SGB4

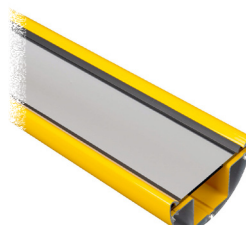

FMC-S3 / FMC-S4

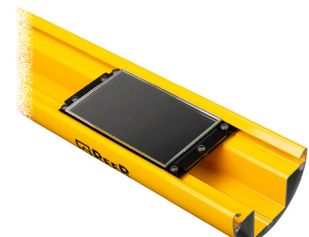

FMC-SB3 / FMC-SB4



FMC-CB





FMC-CBL

ReeR Safegate Light Curtains – Body Protection

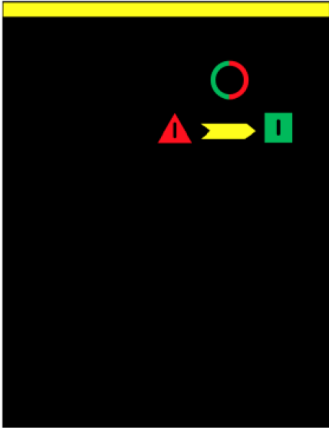
Emitter (non TRX models) LED Functions



TRI-COLOR LED			
RED 	YELLOW 	GREEN 	MEANING
On	-	-	Power on - Initial Test
Flashing	-	-	Fail condition
-	On	-	Curtain under test
-	-	On	Normal operation

Fault Diagnostics (non TRX models)

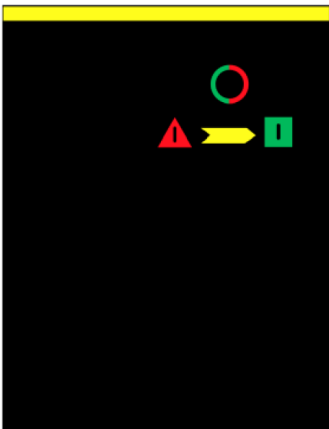

NUMBER OF FLASHES	ERROR	POSSIBLE CAUSE
RED 	<i>POSSIBLE CAUSE</i>	<i>POSSIBLE CAUSE</i>
2	RANGE0 / RANGE1 incorrect wiring	Check pin 2 and 4 connections on the main connector
3/4	Internal error	Contact tech support
5	SYNC incorrect wiring	Check pin 2 connection on the sensors connectors

ReeR Safegate Light Curtains – Body Protection

Receiver/Active (All Models) – LED Functions



LED							MEANING
PRG ●	● COM	● CLR	● OVR	● MUT	● S 1 ● S 2	● S 3 ● S 4	
Blue							Curtain programmed via USB
	Orange						Communication with active PC
	Blue						Weak signal (TRXmodels only)
	Alternating Blue/Orange						Weak signal (TRXmodels only)
		Yellow					Curtain awaiting RESTART (clear gate)
			Green				Normal operation (clear gate)
			Red				Occupied gate
			Red flashing				Detected failure (Refer to "Troubleshooting" section in User's Manual)
				Yellow			Muting active
					Yellow		Override active
					Yellow flashing		Override request
						Yellow	Sensor interrupted
Blue flashing	Orange flashing						No barrier configuration
Blue flashing	Orange flashing		Red flashing				Detected double configuration (hardware and software) – SMPO only



BREAK
Occupied curtain with at least one occupied beam



FAIL
Curtain in error condition

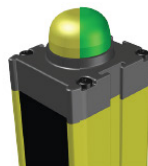

CLEAR
Curtain awaiting RESTART

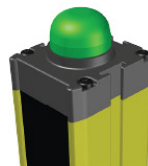

GUARD
Normal operation condition

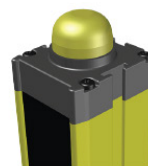

MUTING
Muting underway

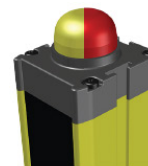

OVERRIDE
(Request)

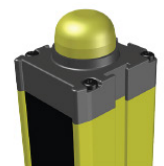

OVERRIDE
(In progress)

LIGHT	MEANING
Yellow/Green	Curtain awaiting RESTART (gate clear)
Green	Normal operation (gate clear)
Red	Occupied gate
Red Flashing	Detected failure (see DIAGNOSTICS)
Yellow	Muting active
Yellow Flashing	Override active
Yellow/Red	Override request

ReeR Safegate Light Curtains – Body Protection

Fault Diagnostics

NOTE regarding SMP and SMPO models: In addition to the corresponding LED indication, when the operator connects SAFEGATE to a computer via USB, a pop-up window with the error code appears on the monitor.



	LED				ERROR	POSSIBLE CAUSE
		CLR	MUT	OVR		
2					Configuration error SEL_A/SEL_B/EDM	Pin 6-8-11 connections on the RX male connector
2				2 (S1/S2)	Inconsistency between red and blue connector selection for S2 wiring and the physical wiring of S2	Wire S2 with the selected wiring option (red or blue connector)
3					Wrong EDM configuration	Pin 8 connections on the RX male connector
3	3				EDM feed back failure	Contact connectors EDM Power Contactors
3		3			STATUS input failure	Pin 12 connections on the RX male connector
3			3		Override1 / Override2 input failure	Pin connections9-10 on the male connector on the RX
3				3	Sensor input failure	Pin connections 2-4 on the sensor connectors
3	3	3	3		MUTING LAMP FAILURE	Connections on the auxiliary lamp connector
4					OSSD1 / OSSD2 error	3-4 pin connectors on the male connector on the RX
5					MAIN CARD ERROR	Contact tech support
5	5				MAIN CARD (EEPROM) error	Contact tech support
5			5		MAIN CARD ERROR	Contact tech support
6					MAIN CARD (Microcontroller) error	Contact tech support
6	6				Generic Default Board Error	6-7-8-9-10-11 pin connections on the male connector on the RX
6		6			Beam error	Contact tech support
6			6		24VDC power supply overload	Eventual short-circuit on OSSD outputs
6		6	6		LAMP/STATUS over current	Short circuit on pin 12 or auxiliary lamp connector
7					Receiving beams failure	Contact tech support
8					Interfering Emitter Detected	Verify the presence of another curtain not correctly positioned. Refer to "Multiple Systems" section of User's Manual.

Safety Products



Warning: Safety products sold by AutomationDirect are Safety components only. The purchaser/installer is solely responsible for the application of these components and ensuring all necessary steps have been taken to assure each application and use meets all performance and applicable safety requirements and/or local, national and/or international safety codes as required by the application. AutomationDirect cannot certify that our products, used solely or in conjunction with other AutomationDirect or other vendors' products, will assure safety for any application. Any person using or applying any products sold by AutomationDirect is responsible for learning the safety requirements for their individual application and applying them, and therefore assumes all risks, and accepts full and complete responsibility, for the selection and suitability of the product for their respective application.

AutomationDirect does not provide design or consulting services, and cannot advise whether any specific application or use of our products would ensure compliance with the safety requirements for any application.