

# ReeR Safegate Light Curtains – Body Protection

Safegate Type 4 access control barriers provide the ideal solution for protection in a wide range of high-risk industrial applications, in particular those requiring a high level of integration of the muting functions. Safegate greatly simplifies seamless integration of muting sensors with light curtain access control barriers

**Hardware configuration  
with integrated status and muting lamp**

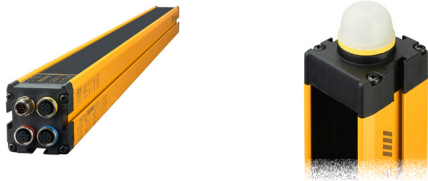

SMO-3B, SMO-4B, SMO-3B-TRX, SMO-4B-TRX

**Hardware or software configuration with  
integrated status and muting lamp**



SMPO-3B, SMPO-4B, SMPO-3B-TRX, SMPO-4B-TRX

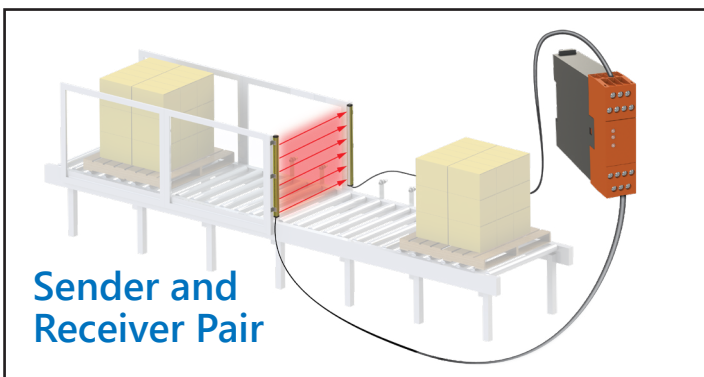

SMO-3B, SMO-4B, SMPO-3B, SMPO-4B

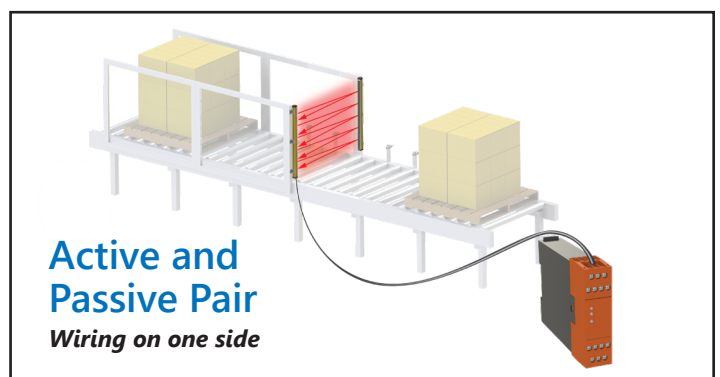

SMO-3B-TRX, SMO-4B-TRX, SMPO-3B-TRX, SMPO-4B-TRX

**One way (2 sensor) crossed**

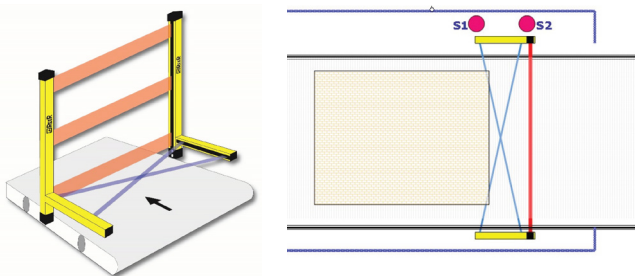

MA-L2X, MZ-L2XP, MZ-L2XP-TRX

**One way (2 sensor) parallel**

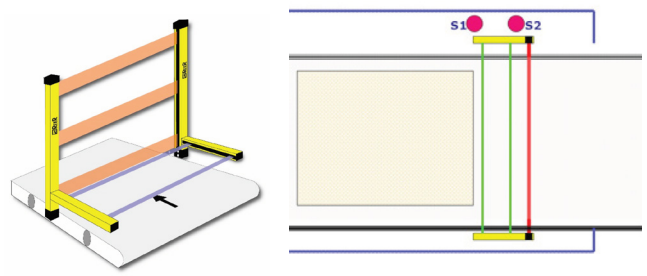

MA-L2P-TRX, MZ-L2XP, MZ-L2XP-TRX

**Two way (2 sensor) crossed**

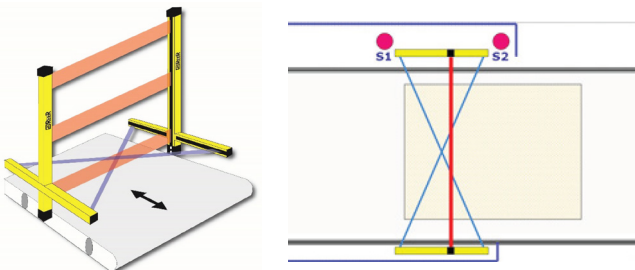

MA-T2X, MZ-T2X, MZ-T2X-TRX

**Two way (4 sensor) parallel**

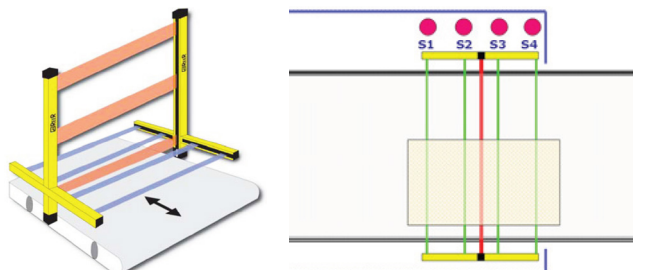

MA-T4P-TRX, MZ-T4P, MZ-T4P-TRX

# ReeR Safegate Light Curtains – Body Protection

## With Muting Arm/Brackets

**Muting Arms:**  
[MA-L2X](#)  
[MA-T2X](#)  
[MA-L2P-TRX](#)  
[MA-T4P-TRX](#)  
 or  
**Muting Brackets:**  
[MZ-L2XP](#)  
[MZ-T2X](#)  
[MZ-T4P](#)  
[MZ-L2XP-TRX](#)  
[MZ-T2X-TRX](#)  
[MZ-T4P-TRX](#)

**Cable**  
 M12 12-pin cable  
*(See recommended items for cabling)*

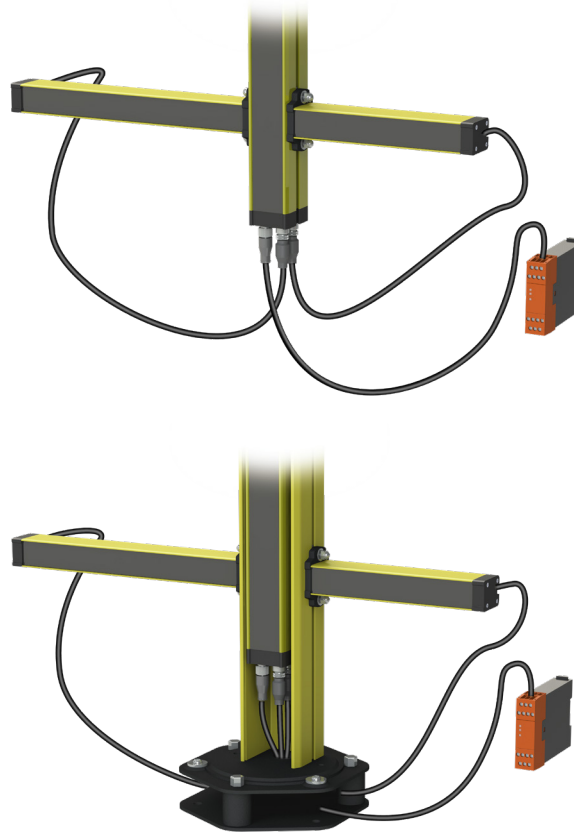

**Light Curtains:**  
[SMO-3B](#)  
[SMO-4B](#)  
[SMPO-3B](#)  
[SMPO-4B](#)  
[SMO-3B-TRX](#)  
[SMO-4B-TRX](#)  
[SMPO-3B-TRX](#)  
[SMPO-4B-TRX](#)  
*If a TRX light curtain is selected, then the muting arms/brackets part number should end in TRX as well.*

**Protective Columns (optional)**  
[FMC-SGB3](#) (for SMxO-3B or SMxO-3B-TRX)  
[FMC-SGB4](#) (for SMxO-4B or SMxO-4B-TRX)  
**Protective Column Base:**  
*(Required with Protective Column)*  
[FMC-CB](#) (shown)  
 or  
[FMC-CBL](#) (not shown)

## With Muting Photocells

**Photo Cells**  
[M5-A](#)  
[M5-B](#)  
[M-TRX-A](#)  
[M-TRX-B](#)

**Y-Splitters**  
[CSY12TX](#)  
[CSY12RX](#)

**Cable**  
 M12 12-pin cable  
*(See recommended items for cabling)*

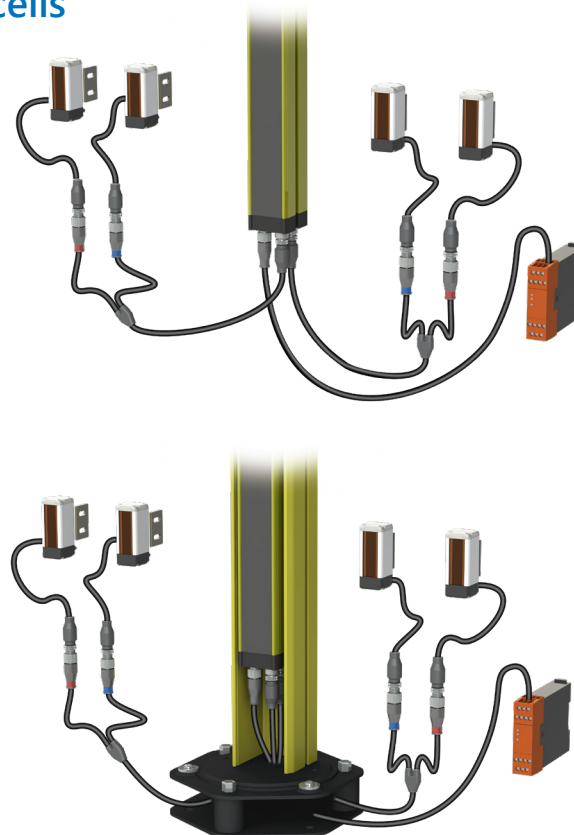

**Light Curtain:**  
[SMO-3B](#)  
[SMO-4B](#)  
[SMPO-3B](#)  
[SMPO-4B](#)  
[SMO-3B-TRX](#)  
[SMO-4B-TRX](#)  
[SMPO-3B-TRX](#)  
[SMPO-4B-TRX](#)  
*If a TRX light curtain is selected, then the muting arms/brackets part number should end in TRX as well.*

**Protective Columns (optional)**  
[FMC-SGB3](#) (for SMxO-3B or SMxO-3B-TRX)  
[FMC-SGB4](#) (for SMxO-4B or SMxO-4B-TRX)  
**Protective Column Base:**  
*(Required with Protective Column)*  
[FMC-CB](#) (shown)  
 or  
[FMC-CBL](#) (not shown)

# ReeR Safegate Light Curtains – Body Protection



## Features

- Integrated muting functions
- Pre-configured and pre-wired muting arms and muting brackets (sold separately)
- Hardware or software configuration options
- Bright LED status and muting lamp
- Status display on unit
- Fully scalable
- Passive retro-reflective elements available (TRX)

## Benefits of Software Configurable Models (SMPO-xxx)

- Upload/download settings
- Specify muting parameters
- Utilize up to two partial muting configurations
- Check and validate programmable configuration
- Light curtain status and monitoring
- Free configuration software

ReeR Safegate Light Curtains – Body Protection With Muting Functions – Selection Chart												
Part Number	Price	Protective Height Hs mm [in]	Housing Height Hb mm [in]	Total Height Ht mm [in]	Number of Beams	PFHd	Response Time [ms]	MTTFd [years]	DCavg	Weight kg [lb]	Resolution mm [in]	Dimensional Drawing
<b>Sender and Receiver Pair</b>												
<i>Hardware configuration with integrated status and muting LED</i>												
<b>SMO-3B</b>	\$985.00	810 [31.89]	974 [38.33]	1010 [39.76]	3	9.63E-09	5.5	262.4	98.5%	6.08 [13.40]	400 [15.75]	<a href="#">PDF</a>
<b>SMO-4B</b>	\$1,058.00	910 [35.83]	1073 [42.24]	1110 [43.70]	4	1.03E-08	5.5	253.3	98.4%	6.56 [14.46]	300 [11.81]	<a href="#">PDF</a>
<i>Hardware or software configuration with integrated status and muting LED</i>												
<b>SMPO-3B</b>	\$1,006.00	810 [31.89]	974 [38.33]	1010 [39.76]	3	9.63E-09	5.5	262.4	98.5%	6.08 [13.40]	400 [15.75]	<a href="#">PDF</a>
<b>SMPO-4B</b>	\$1,150.00	910 [35.83]	1073 [42.24]	1110 [43.70]	4	1.03E-08	5.5	253.3	98.4%	6.56 [14.46]	300 [11.81]	<a href="#">PDF</a>
<b>Active and Passive Pair</b>												
<i>Hardware configuration with integrated status and muting LED</i>												
<b>SMO-3B-TRX</b>	\$985.00	810 [31.89]	935 [36.79]	970 [38.19]	3	7.58E-09	5.5	401.0	98.2%	5.98 [13.18]	400 [15.75]	<a href="#">PDF</a>
<b>SMO-4B-TRX</b>	\$1,058.00	910 [35.83]	1035 [40.73]	1070 [42.13]	4	7.68E-09	5.5	399.4	99.2%	6.54 [14.42]	300 [11.81]	<a href="#">PDF</a>
<i>Hardware or software configuration with integrated status and muting LED</i>												
<b>SMPO-3B-TRX</b>	\$1,006.00	810 [31.89]	935 [36.79]	970 [38.19]	3	7.58E-09	5.5	401.0	98.2%	5.98 [13.18]	400 [15.75]	<a href="#">PDF</a>
<b>SMPO-4B-TRX</b>	\$1,150.00	910 [35.83]	1035 [40.73]	1070 [42.13]	4	7.68E-09	5.5	399.4	99.2%	6.54 [14.42]	300 [11.81]	<a href="#">PDF</a>

Note: SMO and SMPO are designed to work with integrated muting arms, brackets, or photocells and do not work as stand-alone access barriers.

## Dimensions (see table above)

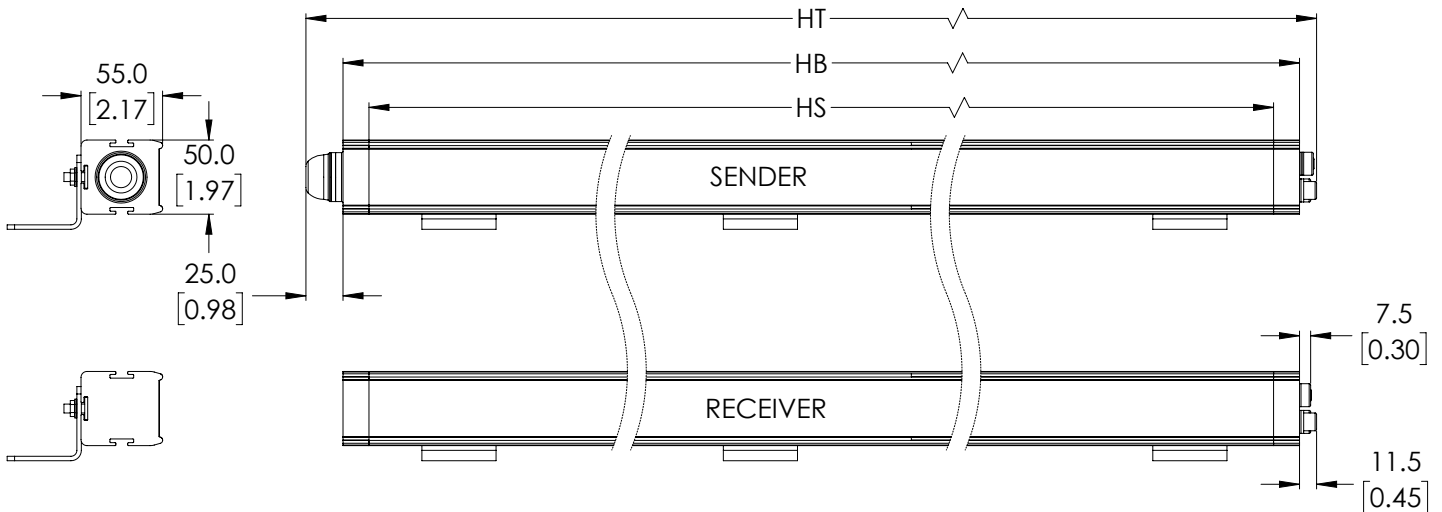

# ReeR Safegate Light Curtains – Body Protection

ReeR Safegate Light Curtains – Body Protection With Muting Functions – Specifications					
		Sender and Receiver Pair		Active and Passive Pair	
		SMO-3B, SMO-4B	SMPO-3B, SMPO-4B	SMO-3B-TRX, SMO-4B-TRX	SMPO-3B-TRX, SMPO-4B-TRX
<b>Supply Voltage</b>		24VDC ±20%		24VDC ±20%	
<b>Safety Outputs (OSSDs)</b>		2 PNP – 400mA @ 24VDC		2 PNP – 400mA @ 24VDC	
<b>Status Outputs</b>		1 PNP – 100mA @ 24VDC		1 PNP – 100mA @ 24VDC	
<b>Operating Temperature</b>		-30°C to 55°C [-22°F to 131°F]		-30°C to 55°C [-22°F to 131°F]	
<b>LED Status Lamp</b>		LED indication of Muting and Curtain Status on RX Curtain	LED indication of Muting, Curtain Status, and Override on RX Curtain	LED indication of Muting and Curtain Status on Active Curtain	LED indication of Muting, Curtain Status, and Override on Receiver Curtain
<b>Safety Category</b>	Type 4	EN 61496-1:2013 IEC 61496-2:2013		EN 61496-1:2013 IEC 61496-2:2013	
	SIL3	IEC 61508-1: (ed.2) IEC 61508-2: (ed.2) IEC 61508-3: (ed.2) IEC 61508-4: (ed.2)		IEC 61508-1: (ed.2) IEC 61508-2: (ed.2) IEC 61508-3: (ed.2) IEC 61508-4: (ed.2)	
	PLe	EN ISO 13849-1:2015		EN ISO 13849-1:2015	
	CAT4	EN ISO 13849-1:2015		EN ISO 13849-1:2015	
<b>CCF</b>		80%		80%	
<b>Degree of Protection</b>		IP65 and IP67		IP65 and IP67	
<b>Working Range</b>		0-4 m [0-13.12 ft] low 0-12 m [0-39.37 ft] high (See Range/Test Selection Chart on next page)		0-8 m [0-26.25 ft]	
<b>Power Consumption</b>		Transmitter: 1W; Receiver: 2W		3W	
<b>Connections</b>		Power on TX: M12 5-pin male Power on RX: M12 12-pin male Muting sensor connectors/muting lamp/configuration: Two M12 5-pin female		Power on Active: M12 12-pin male Muting sensor connectors/muting lamp/configuration: Two M12 5-pin female	
<b>EDM Input</b>		Available on RX, selectable		Available on Active, selectable	
<b>Restart Auto/Manual</b>		Available on RX, selectable		Available on Active, selectable	
<b>Test Input</b>		Available on TX, selectable		Not available	
<b>Configuration</b>		Hardware on RX connector	Hardware or software with USB	Hardware on active element connector	Hardware or software with USB
<b>Conductor requirements</b>		20AWG if length is less than 50m [164.04 ft] 17AWG if length is between 50m [164.04 ft] and 100m [328.1 ft]		20AWG if length is less than 50m [164.04 ft] 17AWG if length is between 50m [164.04 ft] and 100m [328.1 ft]	
<b>Max Connection Length</b>		100m [328.1 ft]		100m [328.1 ft]	
<b>Current Rating Available for Muting Sensors</b>		50mA		50mA	
<b>Muting Lamp Output</b>		24VDC, 0.5 to 5 W		24VDC, 0.5 to 5 W	
<b>Muting Signal Response Time (Sensors)</b>		100ms		100ms	
<b>Muting Signal Logic Levels (Sensors)</b>		<5VDC: Clear Sensor 11-30 VDC: Actuated Sensor		<5VDC: Clear Sensor 11-30 VDC: Actuated Sensor	
<b>Time Out Muting</b>		30s 9h (non-sequential) Can be excluded (sequential)	Configurable via software	30s 9h (non-sequential) Can be excluded (sequential)	Configurable via software
<b>Muting Override</b>		Selectable by pulse or by action maintained	Selectable by pulse or by action maintained; configurable via software	Selectable by pulse or by action maintained	Selectable by pulse or by action maintained; configurable via software
<b>Override Max Timeout</b>		15m (renewable)	15m (renewable) software configurable	15m (renewable)	15m (renewable) software configurable
<b>Maximum Number of Consecutive Overrides</b>		30		30	
<b>Muting Logic</b>		Crossed beams or sequential	Fully configurable with ReeR software	Crossed beams or sequential	Fully configurable with ReeR software
<b>Partial Muting</b>		NA	Possibility to interrupt only a selected number of beams	NA	Possibility to interrupt only a selected number of beams
<b>Tolerance Time Between Sensors 1 and 2</b>		4s	2 to 5 s Configurable via software	4s	2 to 5 s Configurable via software
<b>Muting Enable</b>		Pin on main connector, disabled if not required and monitored		Pin on main connector, disabled if not required and monitored	

# ReeR Safegate Light Curtains – Body Protection

## Pin outs for SMO-3B, SMO-4B, SMPO-3B and SMPO-4B

### Sender

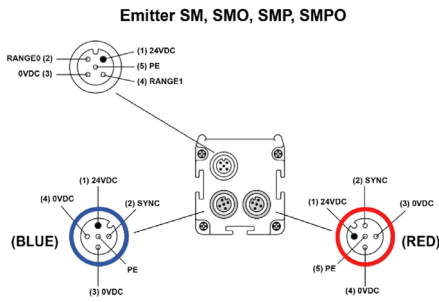

### Receiver

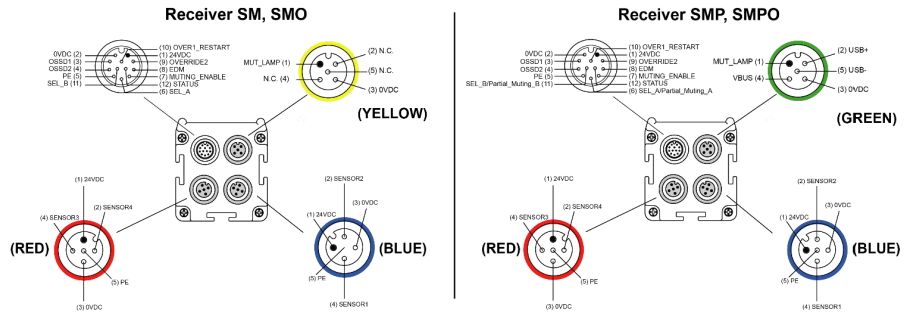

RANGE SELECTION / TEST M12 5 PIN MALE CONNECTOR				
Pin	Color	Signal	In/Out	Description
1	Brown	24VDC	-	24VDC power supply
2	White	RANGE0	Input	Range/Test selection (see chart below)
3	Blue	0VDC	-	0VDC power supply
4	Black	RANGE1	Input	Range/Test selection (see chart below)
5	Gray	PE	-	Ground connection

RANGE / TEST SELECTION		
Pin 2	Pin 4	Function
24DC	0VDC	LOW range
0VDC	24DC	HIGH range
0VDC	0VDC	SAFEGATE in TEST mode
24VDC	24DC	Not allowed

SENSORS 1-2 M12 5-PIN FEMALE CONNECTOR (BLUE)				
Pin	Color	Signal	In/Out	Description
1	Brown	24VDC	-	24VDC sensors power supply
2	White	SYNC	Output	M5 arms synchronisation
3	Blue	0VDC	-	0VDC
4	Black	0VDC	-	0VDC
5	Gray	PE	-	Ground connection

SENSORS 3-4 M12 5-PIN FEMALE CONNECTOR (RED)				
Pin	Color	Signal	In/Out	Description
1	Brown	24VDC	-	24VDC sensors power supply
2	White	SYNC	Output	M5 arms synchronisation
3	Blue	0VDC	-	0VDC
4	Black	0VDC	-	0VDC
5	Gray	PE	-	Ground connection

PRIMARY M12 12-PIN MALE CONNECTOR				
Pin	Color	Signal	In/Out	Description
1	Brown	24VDC	-	24VDC power supply
2	Blue	0VDC	-	0VDC power supply
3	White	OSSD1	Output	Safety static outputs
4	Green	OSSD2	Output	
5	Pink	PE	-	Ground connection
6	Yellow	SEL_A	Input	Muting configuration
		PARTIAL_MUTING_A (see note)		Partial muting control
7	Black	MUT_ENABLE	Input	External muting enable
8	Gray	EDM	Input	K1/K2 feedback
9	Red	VERRIDE2	Input	Override request
		VERRIDE1		Override request
10	Purple	RESTART	Input	Restart interlock
		SEL_B		Muting configuration
		PARTIAL_MUTING_B (see note)		Partial muting control
11	Grey/Pink	STATUS	Input	System status
12	Red/Blue	STATUS	Output	System status

NOTE: PARTIAL\_MUTING signal is present on programmable models (SMP/SMPO)

SENSORS 1-2 – M12 5-PIN FEMALE CONNECTOR (BLUE)				
Pin	Color	Signal	In/Out	Description
1	Brown	24VDC	-	24VDC power supply
2	White	SENSOR2	Input	SENSOR2 status
3	Blue	0VDC	-	0VDC
4	Black	SENSOR1	Input	SENSOR1 status
5	Gray	PE	-	Ground connection

SENSORS 3-4 – M12 5-PIN FEMALE CONNECTOR (RED)				
Pin	Color	Signal	In/Out	Description
1	Brown	24VDC	-	24VDC power supply
2	White	SENSOR4	Input	SENSOR4 status
3	Blue	0VDC	-	0VDC
4	Black	SENSOR3	Input	SENSOR3 status
5	Gray	PE	-	Ground connection

USB/MUTING LAMP CONNECTOR					
Pin	Color	SMO Signal (Yellow)	SMPO Signal (Green)	IN/OUT	Description
1	Brown	MUT_LAMP	MUT_LAMP	Output	Active muting 24VDC
2	White	NC	USB+	In/Out	-
3	Blue	0VDC	0VDC	-	0VDC
4	Black	NC	VBUS	Input	5VDC
5	Gray	NC	USB-	In/Out	-

# ReeR Safegate Light Curtains – Muting Arms

## Features

- Pre-configured and pre-wired muting arms and muting brackets
- MZ series offers five photo beams per sensor, useful for sensing unconventional objects (only one beam on the TRX versions)
- One way (parallel)
- One way (crossed)
- Two way (parallel)
- Two way (crossed)



ReeR Safegate Light Curtains – Muting Arms Selection Chart				
Part Number	Price	Description	Working Range (m [ft])	Dimensional Drawing
<a href="#">MA-L2X</a>	\$316.00	Muting arm, sender/receiver pair, 2 crossed beams, one way	1-2.5 [3.28-8.20]	<a href="#">PDF</a>
<a href="#">MA-T2X</a>	\$475.00	Muting arm, sender/receiver pair, 2 crossed beams, two way	1-2.5 [3.28-8.20]	<a href="#">PDF</a>
<a href="#">MA-L2P-TRX</a>	\$323.00	Muting arm, active/passive pair, 2 parallel beams, one way	0-3.5 [0-11.48]	<a href="#">PDF</a>
<a href="#">MA-T4P-TRX</a>	\$596.00	Muting arm, active/passive pair, 4 parallel beams, two way	0-3.5 [0-11.48]	<a href="#">PDF</a>
<a href="#">MZ-T2X</a>	\$499.00	Bracket with M5, sender/receiver pair, 2 crossed beams, two way	1-3.5 [3.28-11.48]	<a href="#">PDF</a>
<a href="#">MZ-T4P</a>	\$722.00	Bracket with M5 sender/receiver pair, 4 parallel beams, two way	0-3.5 [0-11.48]	<a href="#">PDF</a>
<a href="#">MZ-L2XP</a>	\$369.00	Bracket with M5, sender/receiver pair, 2 crossed or parallel beams, one way	0-3.5 [0-11.48] when parallel 1-3.5 [3.28-11.48] when crossed	<a href="#">PDF</a>
<a href="#">MZ-L2XP-TRX</a>	\$370.00	Bracket with M-TRX, active/passive pair, 2 crossed or parallel beams, one way	0-3.5 [0-11.48] when parallel 1-3.5 [3.28-11.48] when crossed	<a href="#">PDF</a>
<a href="#">MZ-T2X-TRX</a>	\$433.00	Bracket with M-TRX, active/passive pair, 2 crossed beams, two way	1-3.5 [3.28-11.48]	<a href="#">PDF</a>
<a href="#">MZ-T4P-TRX</a>	\$740.00	Bracket with M-TRX, active/passive pair, 4 parallel beams, two way	0-3.5 [0-11.48]	<a href="#">PDF</a>

# ReeR Muting and Automation Photocells

ReeR Muting and Automation Photocells – Selection Chart					
Part Number	Price	Number of Beams	Sensing Range	Coding	Dimensional Drawing
<b>Emitter/Receiver Versions</b>					
<b>M5-A</b>	\$165.00	5	0 to 3.5 m [0 to 11.48 ft]	A	<a href="#">PDF</a>
<b>M5-B</b>	\$162.00	5	0 to 3.5 m [0 to 11.48 ft]	B	<a href="#">PDF</a>
<b>Reflector Versions</b>					
<b>M-TRX-A</b>	\$120.00	1	0 to 5 m [0 to 16.40 ft]*	A	<a href="#">PDF</a>
<b>M-TRX-B</b>	\$122.00	1	0 to 5 m [0 to 16.40 ft]*	B	<a href="#">PDF</a>



M5-A / M5-B

\* Dependent on type of reflector used (see specifications below)

ReeR Muting and Automation Photocells – Specifications			
Model	Micron M5 Emitter	Micron M5 Receiver	M-TRX-A / M-TRX-B
<b>Power Supply</b>	24VDC ± 20%		
<b>Power Consumption at 24VDC</b>	1W		0.2 W
<b>Number of Beams</b>	5		1
<b>Working Range</b>	0-3.5 m [0 to 11.48 ft]		0 to 2.5 m [0 to 8.20 ft] with C3F10 reflector 0 to 3.5 m [0 to 11.48 ft] with C3F8 reflector 0 to 3 m [0 to 9.84 ft] with CD8 reflector
<b>Beams Pitch</b>	10mm [0.39 in]		NA
<b>Immunity to Ambient Light</b>	>10,000 lx (solar)		NA
<b>Emission Angle</b>	±5°	±5°	±5°
<b>Emission Wavelength</b>	940nm (modulated infrared)	-	660nm (modulated red)
<b>Response Time</b>	<10ms	<10ms	65ms
<b>Output</b>	-	PNP 100mA max / dark-on	PNP 100mA max / dark-on
<b>Connections</b>	Pigtail 90cm [2.95 ft] with M12 5 pin connector	Pigtail 90cm [2.95 ft] with M12 5 pin connector	Pigtail 90cm [2.95 ft] with M12 5 pin connector
<b>MTTF<sub>d</sub></b>	414.02 years	414.02 years	1759.31 years
<b>Operating Temperature</b>	-30 to +55°C [-22 to 131°F] (with no condensation)	-30 to +55°C [-22 to 131°F] (with no condensation)	-30 to +55°C [-22 to 131°F] (with no condensation)
<b>Protection Degree</b>	IP65		
<b>Dimensions</b>	Width	28mm [1.10 in]	28mm [1.10 in]
	Depth	30mm [1.18 in]	30mm [1.18 in]
	Height	70mm [2.76 in]	70mm [2.76 in]

### Emitter

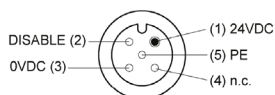

### Receiver

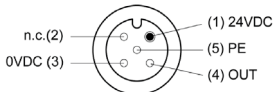

### TRX

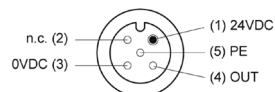

M5 Emitter				
Pin	Color	Signal	Description	
1	Brown	24VDC	24VDC power supply	
2	White	DISABLE	0VDC=ENABLE	24VDC=DISABLE
3	Blue	0VDC	0VDC power supply	
4	Black	NA	Not connected	
5	Gray	PE	Ground connection	

M5 Receiver				
Pin	Color	Signal	Description	
1	Brown	24VDC	24VDC power supply	
2	White	NA	Not connected	
3	Blue	0VDC	0VDC power supply	
4	Black	OUT	0VDC=Area Free	24VDC=Area Obstructed
5	Gray	PE	Ground connection	

M TRX				
Pin	Color	Signal	Description	
1	Brown	24VDC	24VDC power supply	
2	White	NA	Not connected	
3	Blue	0VDC	0VDC power supply	
4	Black	OUT	0VDC=Area Free	24VDC=Area Obstructed
5	Gray	PE	Ground connection	

### Emitter/Receiver Application

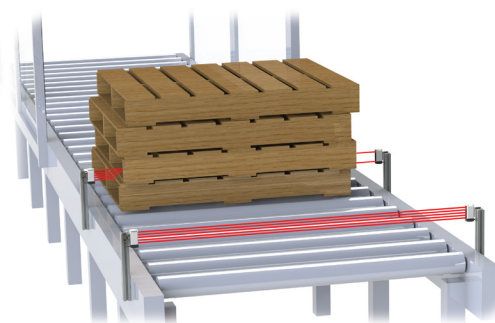

M5 photocells have five beams that are sent out by the emitter. If any one of the five beams is blocked, then the receiver's status signal will change to signify that there is an object in front of the photocell. This is particularly useful when there is a need to detect irregularly shaped items.

# ReeR Safegate Light Curtain Accessories

Safegate Light Curtains Accessories Overview				
Part Number	Price	Description	Use With	Dimensional Drawing
<b>Reflectors</b>				
<a href="#"><b>C3F10</b></a>	\$15.00	ReeR reflector, rectangular, 30 x 116 mm [1.18 x 4.57 in].	<a href="#">M-TRX-A</a> or <a href="#">M-TRX-B</a>	<a href="#">PDF</a>
<a href="#"><b>C3F8</b></a>	\$26.50	ReeR reflector, rectangular, 30 x 78 mm, [1.18 x 3.07 in] with bracket.	<a href="#">M-TRX-A</a> or <a href="#">M-TRX-B</a>	<a href="#">PDF</a>
<a href="#"><b>CD8</b></a>	\$14.50	ReeR reflector, round, 84mm [3.31 in].	<a href="#">M-TRX-A</a> or <a href="#">M-TRX-B</a>	<a href="#">PDF</a>
<b>Mounting Brackets</b>				
<a href="#"><b>SFB-4SG</b></a>	\$57.00	ReeR mounting bracket, replacement, standard, zinc plated steel. Package of 4. Mounting hardware included.	ReeR Safegate Light Curtains	<a href="#">PDF</a>
<a href="#"><b>SFB-6SG</b></a>	\$85.00	ReeR mounting bracket, replacement, standard, zinc plated steel. Package of 6. Mounting hardware included.	ReeR Safegate Light Curtains	<a href="#">PDF</a>
<b>Cables</b>				
<a href="#"><b>CS12USB</b></a>	\$45.00	ReeR programming cable, USB Type A male to 5-pin M12 quick-disconnect, 5-pole, PVC jacket, black, 6.5 ft [2m] cable length.	SMPO models	NA
<a href="#"><b>CSY12RX</b></a>	\$53.00	ReeR muting receiver cable, 5-pin M12 quick-disconnect to (2) 5-pin M12 quick-disconnects, 5-pole, 24 VDC, PVC jacket, black, 1.3 ft [400mm] cable length, IP67.	ReeR Safegate Light Curtains	NA
<a href="#"><b>CSY12TX</b></a>	\$53.00	ReeR muting emitter cable, 5-pin M12 quick-disconnect to (2) 5-pin M12 quick-disconnects, 5-pole, 24 VDC, PVC jacket, black, 1.3ft [400mm] cable length, IP67.	ReeR Safegate Light Curtains	NA



**C3F10**



**SFB-4SG / SFB-6SG**



**CSY12TX / CSY12RX**



**C3F8**



**CD8**

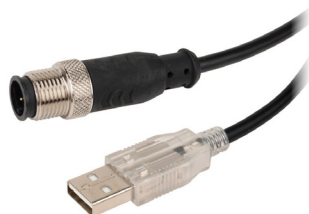

**CS12USB**

When four M5 muting sensors are installed with a ReeR Safegate light curtain, **CSY12TX** and **CSY12RX** Y-splitters will be required.

## Pinouts

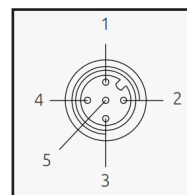
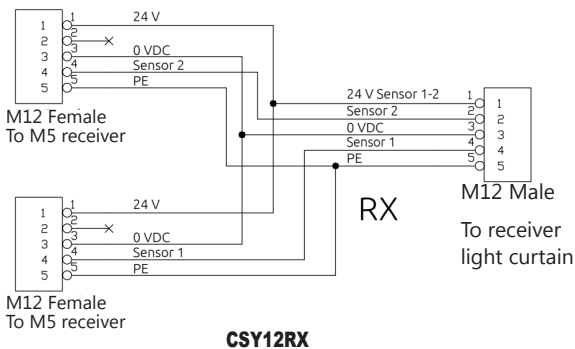
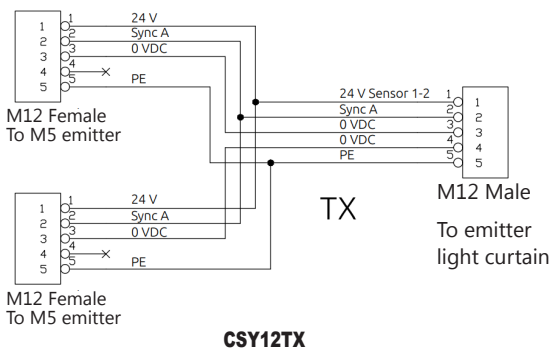



# ReeR Safegate Light Curtain Accessories

Safegate Light Curtains Accessories Overview				
Part Number	Price	Description	Use With	Dimensional Drawing
<b>Protective Columns*</b>				
<a href="#"><u>FMC-SGB3</u></a>	\$191.00	ReeR protective column, 1200mm housing.	SMO-3B SMPO-3B SMO-3B-TRX SMPO-3B-TRX S-3B S-3B-TRX	<a href="#"><u>PDF</u></a>
<a href="#"><u>FMC-SGB4</u></a>	\$203.00	ReeR protective column, 1330mm housing.	SMO-4B SMPO-4B SMO-4B-TRX SMPO-4B-TRX S-4B S-4B-TRX	<a href="#"><u>PDF</u></a>
<b>Mirror Columns*</b>				
<a href="#"><u>FMC-S3</u></a>	\$226.00	ReeR single mirror column, 1200mm housing, 1198mm mirror(s).	SMO-3B SMPO-3B SMO-3B-TRX SMPO-3B-TRX S-3B S-3B-TRX	<a href="#"><u>PDF</u></a>
<a href="#"><u>FMC-S4</u></a>	\$245.00	ReeR single mirror column, 1330mm housing, 1328mm mirror(s).	SMO-4B SMPO-4B SMO-4B-TRX SMPO-4B-TRX S-4B S-4B-TRX	<a href="#"><u>PDF</u></a>
<a href="#"><u>FMC-SB3</u></a>	\$456.00	ReeR three mirror column, 1200mm housing, (3) 150mm mirror(s).	SMO-3B SMPO-3B SMO-3B-TRX SMPO-3B-TRX S-3B S-3B-TRX	<a href="#"><u>PDF</u></a>
<a href="#"><u>FMC-SB4</u></a>	\$525.00	ReeR four mirror column, 1330mm housing, (4) 150mm mirror(s).	SMO-4B SMPO-4B SMO-4B-TRX SMPO-4B-TRX S-4B S-4B-TRX	<a href="#"><u>PDF</u></a>
<b>Column Base</b>				
<a href="#"><u>FMC-CB</u></a>	\$141.00	ReeR column base, 202 x 224 x 55 mm housing. Mounting hardware included.	FMC-Sx	<a href="#"><u>PDF</u></a>
<a href="#"><u>FMC-CBL</u></a>	\$57.00	ReeR column base, 202 x 224 x 37 mm housing. Mounting hardware included.	FMC-Sx	<a href="#"><u>PDF</u></a>

\* Column base must be purchased separately



**FMC-SGB3 / FMC-SGB4**

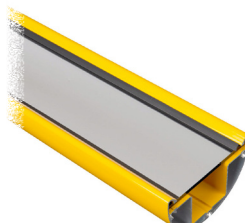

**FMC-S3 / FMC-S4**

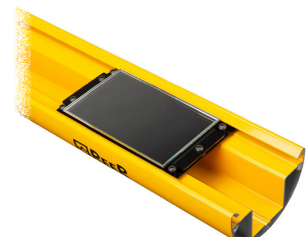

**FMC-SB3 / FMC-SB4**



**FMC-CB**





**FMC-CBL**

# ReeR Safegate Light Curtains – Body Protection

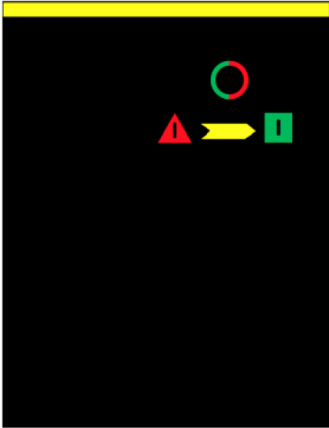
## Emitter (non TRX models) LED Functions



TRI-COLOR LED			
RED 	YELLOW 	GREEN 	MEANING
On	-	-	Power on - Initial Test
Flashing	-	-	Fail condition
-	On	-	Curtain under test
-	-	On	Normal operation

## Fault Diagnostics (non TRX models)

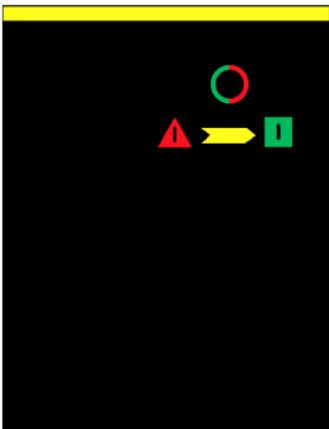

NUMBER OF FLASHES	ERROR	POSSIBLE CAUSE
<b>RED</b> 	<i>POSSIBLE CAUSE</i>	<i>POSSIBLE CAUSE</i>
2	RANGE0 / RANGE1 incorrect wiring	Check pin 2 and 4 connections on the main connector
3/4	Internal error	Contact tech support
5	SYNC incorrect wiring	Check pin 2 connection on the sensors connectors

# ReeR Safegate Light Curtains – Body Protection

## Receiver/Active (All Models) – LED Functions



LED							MEANING
PRG ●	● COM	● CLR	● OVR	● MUT	● S 1 ● S 2	● S 3 ● S 4	
Blue							Curtain programmed via USB
	Orange						Communication with active PC
	Blue						Weak signal (TRXmodels only)
	Alternating Blue/Orange						Weak signal (TRXmodels only)
		Yellow					Curtain awaiting RESTART (clear gate)
			Green				Normal operation (clear gate)
			Red				Occupied gate
			Red flashing				Detected failure (Refer to "Troubleshooting" section in User's Manual)
				Yellow			Muting active
					Yellow		Override active
					Yellow flashing		Override request
						Yellow	Sensor interrupted
Blue flashing	Orange flashing						No barrier configuration
Blue flashing	Orange flashing		Red flashing				Detected double configuration (hardware and software) – SMPO only

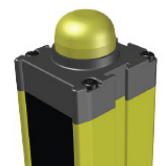
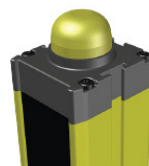

**BREAK**  
Occupied curtain with at least one occupied beam

**FAIL**  
Curtain in error condition

**CLEAR**  
Curtain awaiting RESTART

**GUARD**  
Normal operation condition

**MUTING**  
Muting underway

**OVERRIDE**  
(Request)

**OVERRIDE**  
(In progress)

LIGHT	MEANING
Yellow/Green	Curtain awaiting RESTART (gate clear)
Green	Normal operation (gate clear)
Red	Occupied gate
Red Flashing	Detected failure (see DIAGNOSTICS)
Yellow	Muting active
Yellow Flashing	Override active
Yellow/Red	Override request

# ReeR Safegate Light Curtains – Body Protection

## Fault Diagnostics

**NOTE regarding SMP and SMPO models: In addition to the corresponding LED indication, when the operator connects SAFEGATE to a computer via USB, a pop-up window with the error code appears on the monitor.**

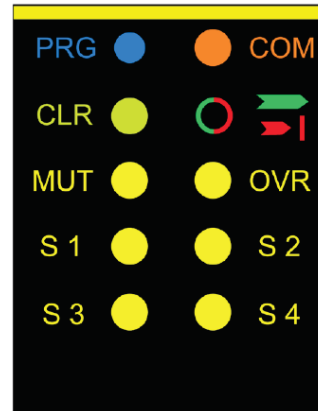

	LED				ERROR	POSSIBLE CAUSE
2					Configuration error SEL_A/SEL_B/EDM	Pin 6-8-11 connections on the RX male connector
2				2 (S1/S2)	Inconsistency between red and blue connector selection for S2 wiring and the physical wiring of S2	Wire S2 with the selected wiring option (red or blue connector)
3					Wrong EDM configuration	Pin 8 connections on the RX male connector
3	3				EDM feed back failure	Contact connectors EDM Power Contactors
3		3			STATUS input failure	Pin 12 connections on the RX male connector
3			3		Override1 / Override2 input failure	Pin connections 9-10 on the male connector on the RX
3				3	Sensor input failure	Pin connections 2-4 on the sensor connectors
3	3	3	3		MUTING LAMP FAILURE	Connections on the auxiliary lamp connector
4					OSSD1 / OSSD2 error	3-4 pin connectors on the male connector on the RX
5					MAIN CARD ERROR	Contact tech support
5	5				MAIN CARD (EEPROM) error	Contact tech support
5			5		MAIN CARD ERROR	Contact tech support
6					MAIN CARD (Microcontroller) error	Contact tech support
6	6				Generic Default Board Error	6-7-8-9-10-11 pin connections on the male connector on the RX
6		6			Beam error	Contact tech support
6			6		24VDC power supply overload	Eventual short-circuit on OSSD outputs
6		6	6		LAMP/STATUS over current	Short circuit on pin 12 or auxiliary lamp connector
7					Receiving beams failure	Contact tech support
8					Interfering Emitter Detected	Verify the presence of another curtain not correctly positioned. Refer to "Multiple Systems" section of User's Manual.

# Safety Products



*Warning: Safety products sold by AutomationDirect are Safety components only. The purchaser/installer is solely responsible for the application of these components and ensuring all necessary steps have been taken to assure each application and use meets all performance and applicable safety requirements and/or local, national and/or international safety codes as required by the application. AutomationDirect cannot certify that our products, used solely or in conjunction with other AutomationDirect or other vendors' products, will assure safety for any application. Any person using or applying any products sold by AutomationDirect is responsible for learning the safety requirements for their individual application and applying them, and therefore assumes all risks, and accepts full and complete responsibility, for the selection and suitability of the product for their respective application.*

*AutomationDirect does not provide design or consulting services, and cannot advise whether any specific application or use of our products would ensure compliance with the safety requirements for any application.*