

Thermocouple Input Terminals

PX-332-K \$342.00

Two-channel Type K Thermocouple Input Terminal

The PX-332-K (type 3) Thermocouple Input Terminal provides two Type K thermocouple inputs with full linearization, cold-junction compensation, and LED status.

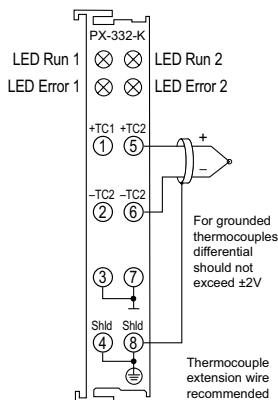

General Specifications	
Operating Temp	0 to 55 °C
Storage Temp	-25 to 85 °C
Relative Humidity	5% to 95%, non-condensing
Environment Air	No corrosive gases permitted
Mounting/Orientation Restrictions	35mm DIN rail/None
Vibration	Conforms to EN 60068-2-6
Shock	Conforms to EN 60068-2-27/ EN 60068-2-29
Noise Immunity	Conforms to EN 61000-6-2/ EN61000-6-4
Protection Class	IP20
Weight	70g (2.4 oz)
Dimensions (WxHxD)	12 x 100 x 68.8 mm (0.47 x 3.94 x 2.71 in)
Adjacent Mounting on Bus Terminals with Power Contact	Yes
Adjacent Mounting on Bus Terminals without Power Contact	Yes
Passes Terminal Bus Power	No
Passes PE Bus	No
Agency Approvals*	UL/cUL File No. E157382, CE

*To obtain the most current agency approval information, see the Agency Approval Checklist section on the specific part number's web page.

Terminal Specifications	
Number of Channels	2
Range	-100 to 1370 °C
Resolution	0.1 °C per digit
Input Type	Type K thermocouple
Data Bytes Consumed	PX-MOD: 4 bytes input PX-TCP1/TCP2: 8 bytes in/ 8 bytes out (not used)
Connection Method	2-wire (Thermocouple extension wire recommended)
Power Supply	Via I/O Bus
Conversion Time	Approx. 250ms
Measuring Current	5mA typical
Linearity Error	$\pm 0.5\%$ (relative to full scale value)
Current Consumption (from I/O Bus)	65mA
Electrical Isolation	500Vms (I/O bus/field potential)
Heat Dissipation	1W max
Status Indicators	4, see LED Status chart

LED Status		
LED	LED ON	LED OFF
Green LED: RUN	Normal Operation	Watchdog-timer overflow if no data transmitted within WD set time.
Red LED: ERROR	Sensor fault, e.g. broken wire	No Error

PX-334-K \$393.00

Four-channel Type K Thermocouple Input Terminal

The PX-334-K (type 3) Thermocouple Input Terminal provides four Type K thermocouple inputs with full linearization, cold-junction compensation, and LED status.

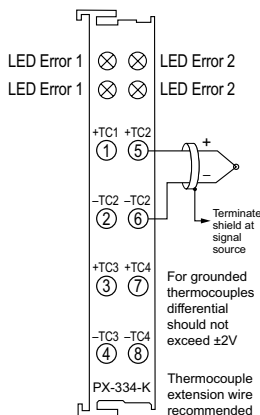

General Specifications	
Operating Temp	0 to 55 °C
Storage Temp	-25 to 85 °C
Relative Humidity	5% to 95%, non-condensing
Environment Air	No corrosive gases permitted
Mounting/Orientation Restrictions	35mm DIN rail/None
Vibration	Conforms to EN 60068-2-6
Shock	Conforms to EN 60068-2-27/ EN 60068-2-29
Noise Immunity	Conforms to EN 61000-6-2/ EN61000-6-4
Protection Class	IP20
Weight	70g (2.4 oz)
Dimensions (WxHxD)	12 x 100 x 68.8 mm (0.47 x 3.94 x 2.71 in)
Adjacent Mounting on Bus Terminals with Power Contact	Yes
Adjacent Mounting on Bus Terminals without Power Contact	Yes
Passes Terminal Bus Power	No
Passes PE Bus	No
Agency Approvals*	UL/cUL File No. E157382, CE

*To obtain the most current agency approval information, see the Agency Approval Checklist section on the specific part number's web page.

Terminal Specifications	
Number of Channels	4
Range	-100 to 1370 °C
Resolution	0.1 °C per digit
Input Type	Type K thermocouple
Data Bytes Consumed	PX-MOD: 8 bytes input PX-TCP1/TCP2: 16 bytes in/ 16 bytes out (not used)
Connection Method	2-wire (Thermocouple extension wire recommended)
Power Supply	Via I/O Bus
Conversion Time	Approx. 250ms
Measuring Current	5mA typical
Linearity Error	$\pm 0.5\%$ (relative to full scale value)
Current Consumption (from I/O Bus)	75mA
Electrical Isolation	500Vms (I/O bus/field potential)
Heat Dissipation	1W max
Status Indicators	4, Red: sensor fault/broken wire

System Installation and Removal

Bus Coupler and Bus Terminal Installation

Bus Coupler Installation:

1. Attach a Bus Coupler by snapping it onto 35mm DIN rail and securing it into position using the DIN rail locking wheel (where applicable) located on the left side of the coupler.

Bus Terminal Installation:

2. To add a bus terminal, insert unit onto right side of Bus Coupler using the tongue and groove at the top and bottom of the unit, pressing gently until it snaps onto the DIN rail.
- A proper connection cannot be made by sliding the units together on the DIN rail. When correctly installed, no significant gap can be seen between the attached units. Bus connection is made through the six slide contacts located on the upper right side of the units. Add up to 64 bus terminals per Bus Coupler, including a bus end terminal.

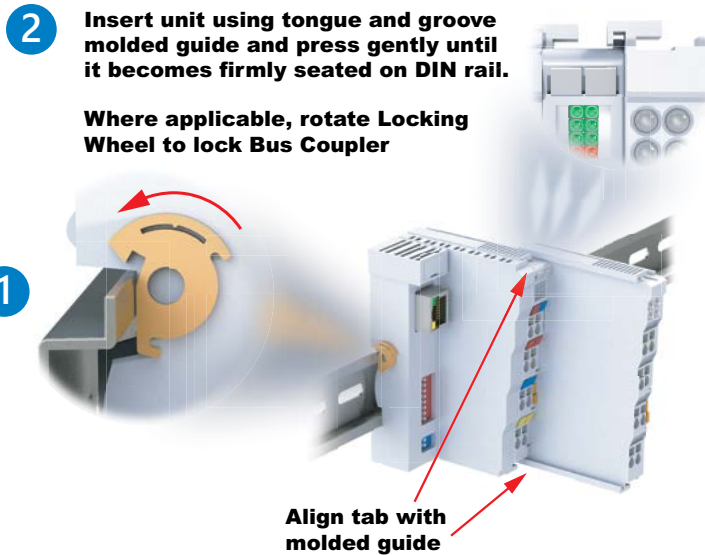

Wiring Connections

- Wire connection is made through a spring clamp style terminal. This terminal is designed for a single-conductor solid or stranded wire. Wire connection is made by firmly pushing the screwdriver into the screwdriver slot, inserting the wire into the wire slot and removing the screwdriver, locking the wire into position.

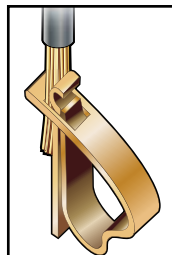
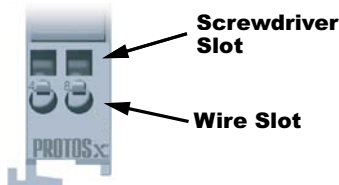

Wiring Specifications	
Connection Type	Spring Clamp Terminals
Wire Gauge	28–14 AWG (0.08–2.5 mm ²)
Screwdriver Width	2.5 mm (0.10 in) such as P/N TW-SD-MSL-2
Wire Stripping Length	8mm

* For Thermocouple terminals, thermocouple extension wire is recommended

Removing Bus Coupler and Bus Terminals

- A locking mechanism prevents individual units from being pulled off. For bus terminal removal, pull the orange DIN rail release tab firmly to unlatch the unit from the rail. If attached to other terminal units, slide unit forward until released. For Bus Couplers with locking wheels, release the DIN rail locking wheel, then pull firmly on DIN rail release tab.

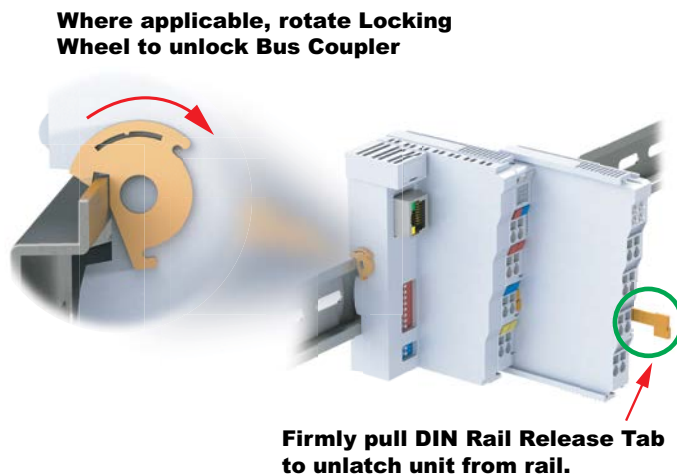

Installation Considerations

Terminal Dimensions and Spacing Requirements

Use the following diagrams to make sure the Protos X system can be installed in your application. Protos X terminals require 35mm DIN rail for mounting; there are no orientation restrictions.

To ensure proper airflow for cooling purposes, units should be spaced, at a minimum, as shown. It is also important to check the Protos X dimensions against the conditions required for your application.

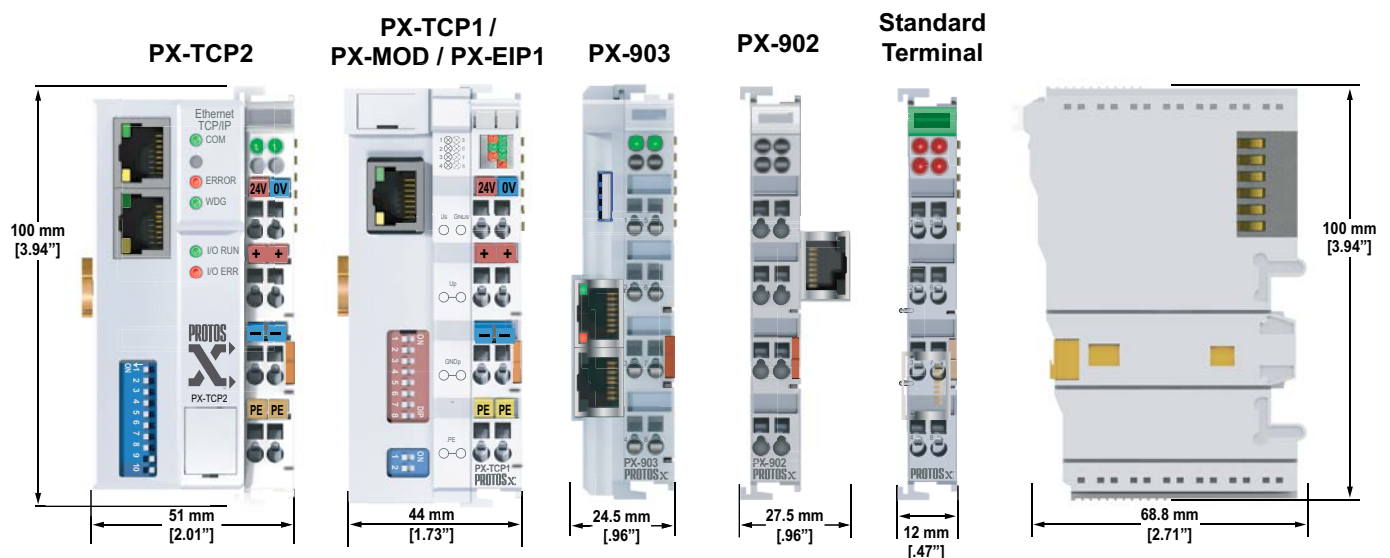

Installation Considerations

Terminal Types

TYPE 1	TYPE 2	TYPE 3
 <p>I/O Bus contacts</p> <p>Terminal power bus contact</p> <p>Terminal power bus pass through</p> <p>Terminal power bus contact</p> <p>Terminal power bus pass through</p>	 <p>I/O Bus contacts</p> <p>Terminal power bus contact</p> <p>Terminal power bus pass through</p> <p>Terminal power bus contact</p> <p>Terminal power bus pass through</p> <p>Terminal PE bus contact</p> <p>Terminal PE bus pass through</p> <p>PROTOS_x</p>	 <p>I/O Bus contacts</p> <p>Terminal power bus contact</p> <p>Terminal power bus pass through</p> <p>Terminal power bus contact</p> <p>Terminal power bus pass through</p> <p>Terminal PE bus contact</p> <p>Terminal PE bus pass through</p> <p>PROTOS_x</p> <p>Note, bus and pass through contacts do not exist on this module</p>
<p>Type 1: This terminal passes the terminal power bus from the preceding terminal to the next terminal and therefore it must be mounted to a preceding terminal that passes bus power.</p>	<p>Type 2: This terminal passes the terminal power bus and PE from the preceding terminal to the next terminal and therefore it must be preceded by a terminal that passes both terminal power bus and PE.</p>	<p>Type 3: This terminal does not pass the terminal power bus or PE and can be preceded by any terminal, however it will interrupt the terminal power bus and PE.</p>

TYPE 4	TYPE 5
 <p>I/O Bus contacts</p> <p>Terminal power bus supply</p> <p>Terminal power bus supply</p> <p>Terminal power bus supply</p> <p>PX-970</p> <p>Note, bus contacts do not exist on this module</p>	 <p>I/O Bus contacts</p> <p>PROTOS_x</p> <p>Note, bus and pass through contacts do not exist on this module</p>
<p>Type 4: This terminal requires external voltage connection and supplies the terminal power bus to terminals located to its right. The terminals to its right must support the same power bus of 120/230 VAC or 24VDC. This terminal will not pass terminal power or PE from any preceding terminals.</p>	<p>Type 5: This terminal is used to separate the terminal power bus and PE from other terminals and can be mounted next to any terminal.</p>