

Enclosure Heating and Heater Selection

Why Heat an Enclosure?

Today's miniaturization of enclosure components results in high packing densities, which in turn results in higher temperatures within the enclosure. These high temperatures are harmful to electronic components. In response, cooling systems have become standard in many applications. However, just as critical and widely underestimated, are failures caused by the formation of moisture.

Under certain climatic conditions, moisture can build up not only in outdoor or poorly insulated enclosures, but also in highly protected and well-sealed enclosures.

Moisture and Failure

Moisture, especially when combined with aggressive gases and dust, causes atmospheric corrosion and can result in the failure of components such as circuit breakers, busbars, relays, integrated circuit boards and transformers. The greatest danger lies in conditions where electronic equipment is exposed to relatively high air humidity or extreme variations in temperature, such as day-and-night operation or outdoor installation. Failure of components in such cases is usually caused by changing contact resistances, flashovers, creepage currents or reduced insulation properties.

Eliminate Moisture

Moisture and corrosion will remain low if relative air humidity stays below 60%. However, relative humidity above 65% will significantly increase moisture and corrosion problems. This can be prevented by keeping the environment inside an enclosure at a temperature as little as 9°F (5°C) higher than that of the ambient air. Constant temperatures are a necessity to guarantee optimal operating conditions. Continuous temperature changes not only create condensation but they reduce the life expectancy of electronic components significantly. Electronic components can be protected by cooling during the day and heating at night.

Thermal Management

Modern enclosure heaters are designed to protect against condensation. They heat the air inside enclosures, preventing water vapor from condensing on components while providing the greatest possible air circulation and low energy consumption.

Other heating element technology improvements include:

- Longer operating life
- Greater energy efficiencies
- Quick wiring options
- Easier mounting
- Fan heaters should be considered for larger enclosures to ensure that the entire enclosure is heated uniformly

Heater Location

Ideally, most heaters will perform optimally when mounted near the bottom of an enclosure and used in conjunction with a control device, thermostat, and/or hygostat. The control device may be a separate device, or it may be integral to the heater. With the controller located in an area of the cabinet that is representative of the average temperature or humidity requirement, the heater should then be placed in a position near the bottom of the enclosure. If a separate control device is used, the heater should not be located directly beneath the controller to ensure that the controller is not influenced by direct heat from the heater.

Heater Calculation

Follow Steps 1-5 to determine the heating requirement of an enclosure (US units - left column, metric - right)

STEP 1: Determine the Surface Area (A) of your enclosure which is exposed to open air.

Enclosure Dimensions:

height = _____ feet _____ meters

width = _____ feet _____ meters

depth = _____ feet _____ meters

Choose Mounting Option from next page, and calculate the surface area as indicated

A = _____ ft² or _____ m²

STEP 2: Choose the Heat Transmission Coefficient (k) for your enclosure's material of construction.

painted steel = 0.511 W/(ft²K) 5.5 W/(m²K)

stainless steel = 0.344 W/(ft²K) 3.7 W/(m²K)

aluminum = 1.115 W/(ft²K) 12 W/(m²K)

plastic or insulated stainless = 0.325 W/(ft²K) 3.5 W/(m²K)

k = _____ W/(ft²K) or _____ W/(m²K)

STEP 3: Determine the Temperature Differential (ΔT).

A. Desired enclosure interior temp. = ____°F ____°C

B. Lowest ambient (outside) temp. = ____°F ____°C

Subtract B from A = Temp. diff. (ΔT) = ____°F ____°C

For these calculations, ΔT must be in° Kelvin (K). Therefore, divide ΔT (°F) by 1.8. ΔT = _____ K

STEP 4: Determine Heating Power (PV), if any (generated from existing components, i.e. transformer).

PV = _____ W or _____ W

STEP 5: Calculate the Required Heating Power (PH) for your enclosure based on the above values.

If enclosure is located inside:

PH = (A x k x ΔT) - PV = _____ W

If enclosure is located outside:

PH = 2 x (A x k x ΔT) - PV = _____ W

Enclosure Mounting Types and Surface Area Calculations

1. Free-Standing

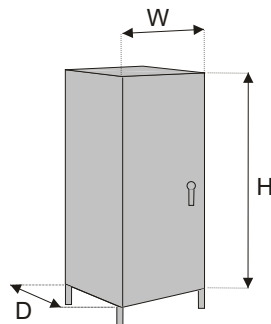

$$\text{Area (A)} = 1.8\text{ft}^2 [0.05\text{m}^2] (H \times W) + 1.8 (H \times D) + 1.8\text{ft}^2 [0.05\text{m}^2] (W \times D)$$

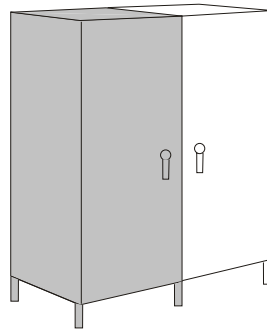

$$\text{Area (A)} = 1.8\text{ft}^2 [0.05\text{m}^2] (H \times W) + 1.4 (H \times D) + 1.8\text{ft}^2 [0.05\text{m}^2] (W \times D)$$

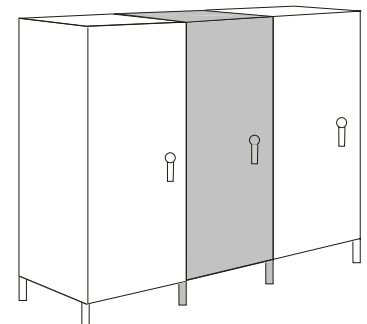

$$\text{Area (A)} = 1.8\text{ft}^2 [0.05\text{m}^2] (H \times W) + (H \times D) + 1.8\text{ft}^2 [0.05\text{m}^2] (W \times D)$$

2. Wall-Mounted

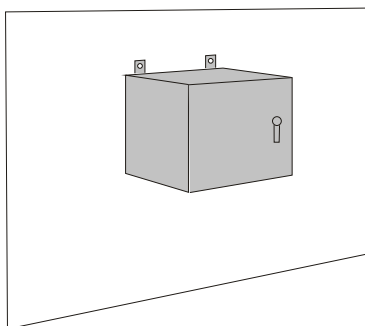

$$\text{Area (A)} = 1.4\text{ft}^2 [0.04\text{m}^2] (H \times W) + 1.8 (H \times D) + 1.8\text{ft}^2 [0.05\text{m}^2] (W \times D)$$

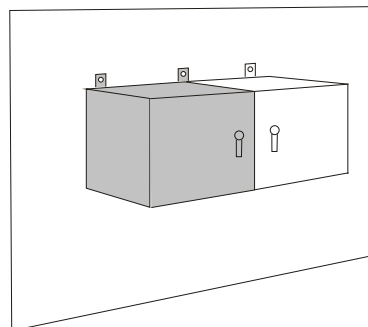

$$\text{Area (A)} = 1.4\text{ft}^2 [0.04\text{m}^2] (H \times W) + 1.4 (H \times D) + 1.8\text{ft}^2 [0.05\text{m}^2] (W \times D)$$

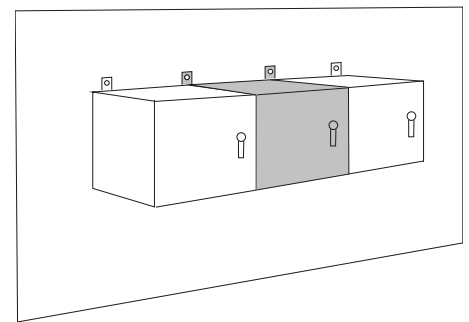

$$\text{Area (A)} = 1.4\text{ft}^2 [0.04\text{m}^2] (H \times W) + (H \times D) + 1.8\text{ft}^2 [0.05\text{m}^2] (W \times D)$$

3. Ground

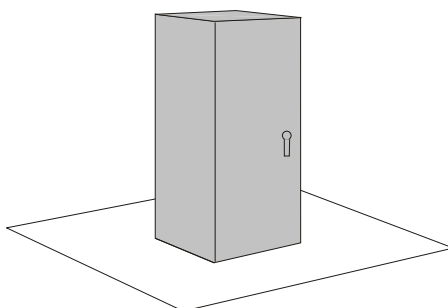

$$\text{Area (A)} = 1.8\text{ft}^2 [0.05\text{m}^2] (H \times W) + 1.8 (H \times D) + 1.4\text{ft}^2 [0.04\text{m}^2] (W \times D)$$

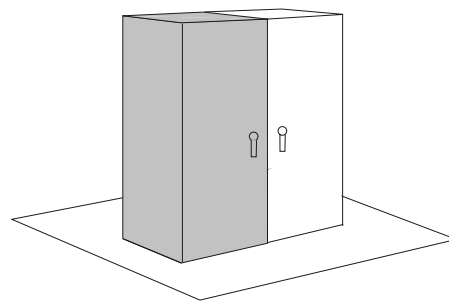

$$\text{Area (A)} = 1.8\text{ft}^2 [0.05\text{m}^2] (H \times W) + 1.4 (H \times D) + 1.4\text{ft}^2 [0.04\text{m}^2] (W \times D)$$

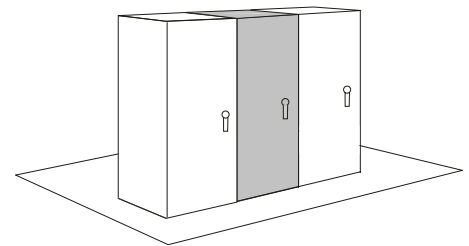

$$\text{Area (A)} = 1.8\text{ft}^2 [0.05\text{m}^2] (H \times W) + (H \times D) + 1.4\text{ft}^2 [0.04\text{m}^2] (W \times D)$$

4. Ground and Wall

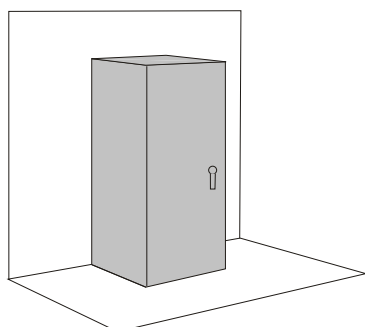

$$\text{Area (A)} = 1.4\text{ft}^2 [0.04\text{m}^2] (H \times W) + 1.8 (H \times D) + 1.4\text{ft}^2 [0.04\text{m}^2] (W \times D)$$

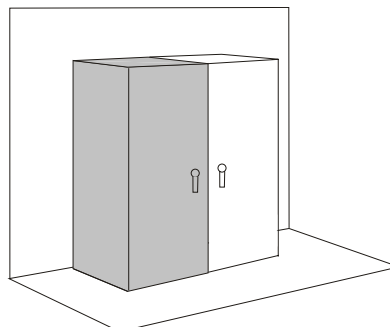

$$\text{Area (A)} = 1.4\text{ft}^2 [0.04\text{m}^2] (H \times W) + 1.4 (H \times D) + 1.4\text{ft}^2 [0.04\text{m}^2] (W \times D)$$

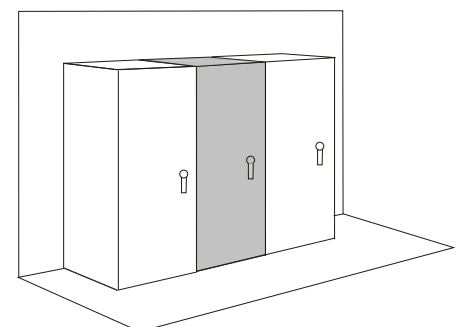

$$\text{Area (A)} = 1.4\text{ft}^2 [0.04\text{m}^2] (H \times W) + (H \times D) + 1.4\text{ft}^2 [0.04\text{m}^2] (W \times D)$$

5W to 13W PTC Heaters

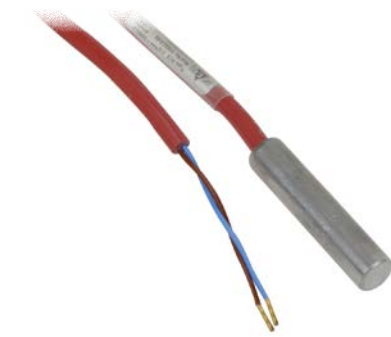

5W, 9W

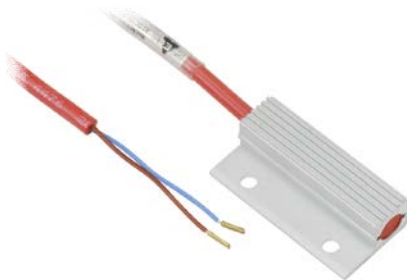

8W, 10W, 13W

Applications

STEGO small positive temperature coefficient heaters are designed to prevent failure of electronic components caused by condensation, corrosion and low temperatures in small enclosures.

Features

- Compact size
- Wide voltage range
- Energy saving
- Heating power adjusts to ambient temperature



5W to 13W PTC Heaters	
Heating Element	PTC Resistor - Temperature limiting
Heater Body	Aluminum, anodized
Insulation	PTFE / Kapton
Mounting	5W, 9W
	8W, 10W, 13W
Mounting Position	Variable
Operating / Storage Temperature	-49 to 158°F [-45 to 70°C]
Operating / Storage humidity	Max 90% RH (non-condensing)
Protection Class	II (double insulated)
Protection Type	IP54
Approvals	CE, VDE, UL Recognized File No. E234324 and E150057,

Note: To obtain the most current agency approval information, see the Agency Approval Checklist section on the specific part number's web page at www.automationdirect.com

5W to 13W PTC Heaters Specifications						
Part Number	Price	Heating Capacity ¹	Operating Voltage ²	Max. current (inrush)	Surface Temperature ¹	Weight (approx.)
016240-03	\$14.50	5W	12-24 VAC/VDC	5.8 A	284°F [140°C]	0.7 oz [20g]
016220-03	\$15.00	5W	120-240 VAC/VDC	2.0 A	329°F [165°C]	
016020-03	\$16.50	8W	12-24 VAC/VDC	3.7 A	273°F [134°C]	
016020-00	\$15.00	8W	120-240 VAC/VDC	2.0 A	302°F [182°C]	
016230-01	\$14.00	9W	120-240 VAC/VDC	2.5 A	347°F [150°C]	
016250-02	\$23.50	9W	12-24 VAC/VDC	2.4 A	360°F [175°C]	
016090-01	\$16.50	10W	12-24 VAC/VDC	5.7 A	270°F [132°C]	1.0 oz [28g]
016090-00	\$16.50	10W	120-240 VAC/VDC	2.5 A	311°F [155°C]	
016100-01	\$19.00	13W	12-24 VAC/VDC	10.0 A	298°F [148°C]	1.2 oz [34g]
016100-00	\$19.00	13W	120-240 VAC/VDC	3.0 A	338°F [170°C]	

Notes: ¹ At 68°F [20°C] ambient temperature
² Operating high voltage heaters below 140V AC/DC reduces heating performance by approximately 10% (min. 110V, max. 265V)

5W to 13W PTC Heaters



Dimensions

016220-03, 016230-01, 016240-03, 016250-02

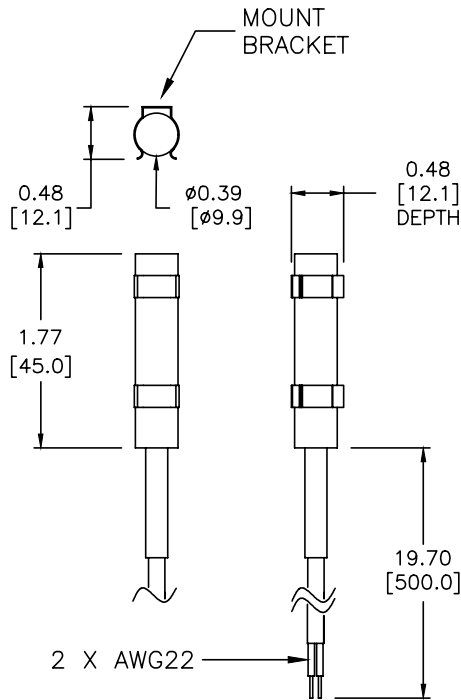

016100-00, 016100-01

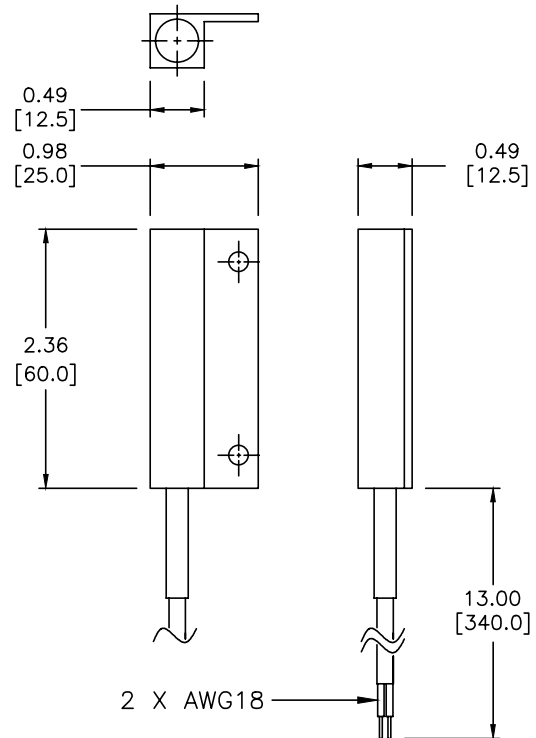

016090-00, 016090-01

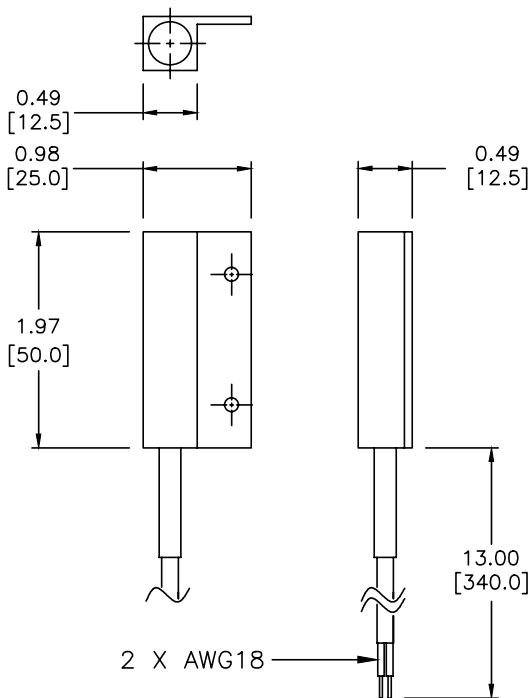

016020-00, 016020-03

