

# pro<sup>sense</sup>® Thermocouple Spring-Loaded Probes with Hex Nipple

THMJ & K - HXXL01-02

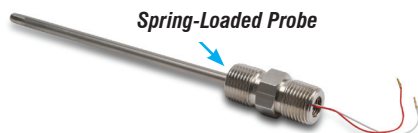

**CHSC-AL-1**



**CHTB-2**

Accessories

## Overview

- Spring-loaded for positive tip contact in thermowells
- Type J or K thermocouple elements to meet many temperature sensing applications
- 1/4" diameter, 316 SS sheath to protect against harsh environments
- Magnesium Oxide (MgO) insulation provides vibration dampening and protection against thermal shock
- 4" , 6" or 12" probe length
- 316 SS, 1/2 x 1/2 NPT hex nipple allows easy replacement of existing probes and connection to a wiring junction box
- Made in the USA

## Thermocouple Spring-Loaded Probes with Hex Nipple - Types J and K

Part Number	Pcs/Pkg	Wt (lb)	Price	Type	Probe Diameter (O.D.)	Probe Length	Temperature Sensing Range	Mounting
<a href="#">THMJ-H04L01-02</a>	1	0.5	\$51.00	J	1/4"	4"	0 to 720°C (32 to 1330°F)	Integral 1/2" x 1/2" NPT Hex Nipple, 316 SS
<a href="#">THMJ-H06L01-02</a>			\$56.00	J		6"		
<a href="#">THMJ-H12L01-02</a>			\$59.00	J		12"		
<a href="#">THMK-H04L01-02</a>			\$51.00	K		4"	0 to 927°C (32 to 1700°F)	
<a href="#">THMK-H06L01-02</a>			\$56.00	K		6"		
<a href="#">THMK-H12L01-02</a>			\$59.00	K		12"		

## Technical Specifications

<b>Junction Type</b>	Ungrounded
<b>ASTM E230 Standard Limits of Error</b>	±2.2°C (±4.0°F) or 0.75%, whichever is greater
<b>Probe</b>	ø1/4", 316 stainless steel sheath, single thermocouple element is embedded in MgO powder
<b>Response Time</b>	2.9 seconds, 63.2% of a 25-77°C step change per method ASTM E839
<b>Wiring</b>	3 inch stranded 24 AWG wire leads with terminal pins, Teflon insulation

Note: See end of section for thermowells to fit these units.



Note: Check the chemical compatibility of the sensor's wetted parts with the medium to be measured.

# proSense® Thermocouple Spring-Loaded Probes with Hex Nipple

## Dimensions

inches [mm]

THMJ & K - HXXL01-02

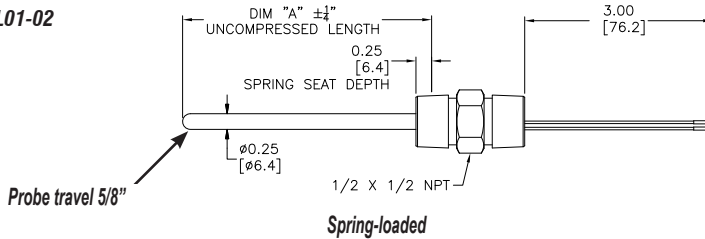

PART NUMBER	DIM "A"
THMJ-H04L01-02	4.00[101.6]
THMJ-H06L01-02	6.00[152.4]
THMJ-H12L01-02	12.00[304.8]
THMK-H04L01-02	4.00[101.6]
THMK-H06L01-02	6.00[152.4]
THMK-H12L01-02	12.00[304.8]

## Wiring Information

Type J: (+) white (-) red  
 Type K: (+) yellow (-) red

- Must use thermocouple extension lead wire
- Observe polarity when making connections
- Do not use standard wire nuts

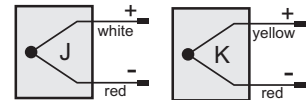

## Accessories

Part No.	Description	Pcs/Pkg	Price
<b>CHSC-AL-1</b>	ProSense general purpose screw cover connection head for temperature probes, die-cast aluminum, 1/2 inch NPT process opening, 3/4 inch NPT conduit opening, NEMA 4X, IP66 rated, graphite gasket, maximum temperature rating of 825°F (440°C). Order probe and terminal base separately.	1	\$23.00
<b>CHTB-2</b>	ProSense ceramic terminal base, two brass terminals with stainless steel screws, for use with ProSense temperature probe connection heads, two mounting screws included.	1	\$6.00

Note: Full listing of accessories at the end of this section. Thermocouple extension lead wire available at [www.automationdirect.com](http://www.automationdirect.com).

## Dimensions

inches [mm]

CHSC-AL-1

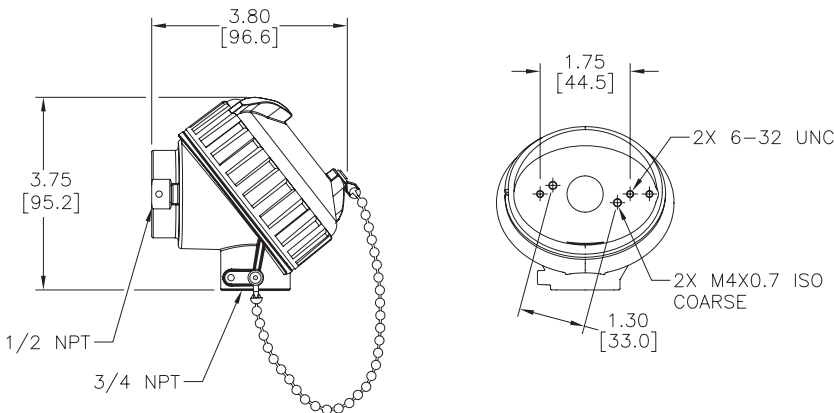

CHTB-2

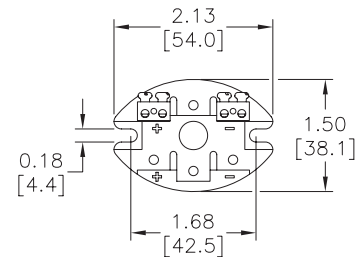

# proSense® Thermocouple, RTD, and Thermistor Connectors

## Overview

- Glass-filled high quality thermoplastic body with original thermocouple material pins and spring-loaded inserts
- Polarized pins
- Molded barriers prevent short circuit
- Captive central cover screw for easy assembly
- Easy wire connection pressure plate
- construction
- Stainless steel screws with combination head (Slotted and Phillips)
- 3-pin standard connectors have a third pin for ground or continuous shield, or for 3-wire RTDs

Thermocouple, RTD, and Thermistor Connectors												
Part Number	Pcs/ Pkg	Wt(lb)	Price	Sensor Type	Connector Type	Temperature Rating	Body Color	Wire Size	Wire Cable Clamp Bracket			
<a href="#">THMJ-SP</a>	1	0.5	\$4.00	J	Standard round pin plug	Max continuous 400°F (200°C)	Black	32 AWG (0.2 mm) to 14 AWG maximum (2.0 mm)	WCB-S			
<a href="#">THMJ-SJ</a>	1	0.5	\$5.25		Standard round pin jack					-		
<a href="#">THMJ-SPJ</a>	1	0.5	\$10.00		Standard round direct mount jack							
<a href="#">THMJ-MP</a>	1	0.5	\$3.75		Miniature flat pin plug				40 AWG (0.08 mm) to 20 AWG maximum (0.8 mm)		WCB-M	
<a href="#">THMJ-MJ</a>	1	0.5	\$4.25		Miniature flat pin jack							
<a href="#">THMJ-MPJ</a>	1	0.5	\$6.75		Miniature round direct mount jack							
<a href="#">THMK-SP</a>	1	0.5	\$4.50	K	Standard round pin plug		Max continuous 662°F (350°C)	Yellow	32 AWG (0.2 mm) to 14 AWG maximum (2.0 mm)	WCB-S		
<a href="#">THMK-SJ</a>	1	0.5	\$5.50		Standard round pin jack						-	
<a href="#">THMK-SPJ</a>	1	0.5	\$10.00		Standard round direct mount jack							
<a href="#">THMK-MP</a>	1	0.5	\$4.00		Miniature flat pin plug					40 AWG (0.08 mm) to 20 AWG maximum (0.8 mm)		WCB-M
<a href="#">THMK-MJ</a>	1	0.5	\$4.25		Miniature flat pin jack							
<a href="#">THMK-MPJ</a>	1	0.5	\$7.50		Miniature round direct mount jack							
<a href="#">THMK-HSP</a>	1	0.5	\$13.00	Standard hi-temp round pin plug	Max continuous 400°F (200°C)	Brown		32 AWG (0.2 mm) to 14 AWG maximum (2.0 mm)	WCB-S			
<a href="#">THMK-HSJ</a>	1	0.5	\$15.00							Standard hi-temp round pin jack		
<a href="#">THMT-SP</a>	1	0.5	\$4.25	T		Standard round pin plug		Max continuous 400°F (200°C)	Blue	40 AWG (0.08 mm) to 20 AWG maximum (0.8 mm)	WCB-M	
<a href="#">THMT-SJ</a>	1	0.5	\$5.75			Standard round pin jack						-
<a href="#">THMT-SPJ</a>	1	0.5	\$9.50			Standard round direct mount jack						
<a href="#">THMT-MP</a>	1	0.5	\$4.00			Miniature flat pin plug					40 AWG (0.08 mm) to 20 AWG maximum (0.8 mm)	
<a href="#">THMT-MJ</a>	1	0.5	\$4.50			Miniature flat pin jack						
<a href="#">THMT-MPJ</a>	1	0.5	\$8.00			Miniature round direct mount jack						
<a href="#">RTD-SP</a>	1	0.5	\$9.00	RTD		Standard round pin plug	White		32 AWG (0.2 mm) to 14 AWG maximum (2.0 mm)	WCB-S		
<a href="#">RTD-SJ</a>	1	0.5	\$11.50			Standard round pin jack						
<a href="#">NTC-SJ</a>	1	0.5	\$6.75	Thermistor		Standard round pin jack						

[THMT-SP](#)



[THMT-SJ](#)



[THMK-SP](#)



[THMK-SJ](#)



[THMK-MP](#)



[THMJ-MJ](#)



[THMT-SPJ](#)



[THMT-MPJ](#)



[RTD-SP](#)



[RTD-SJ](#)



[THMK-HSP](#)



[THMK-HSJ](#)



[NTC-SJ](#)



# proSense® Thermocouple, RTD, and Thermistor Connectors

## Dimensions

inches [mm]

**THMJ, K, T, & H-SP**

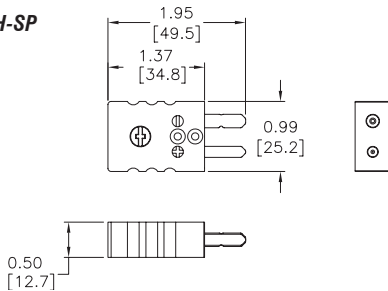

**THMJ, K, T, & H-SJ**

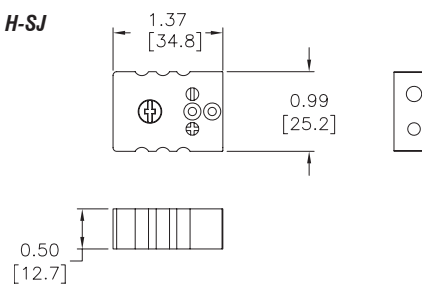

**THMJ, K, & T-MP**

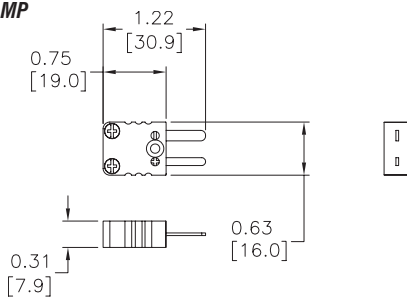

**THMJ, K, & T-MJ**

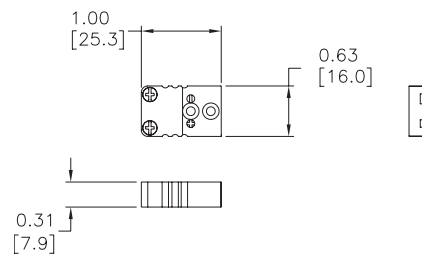

**THMJ, K, & T-SPJ**

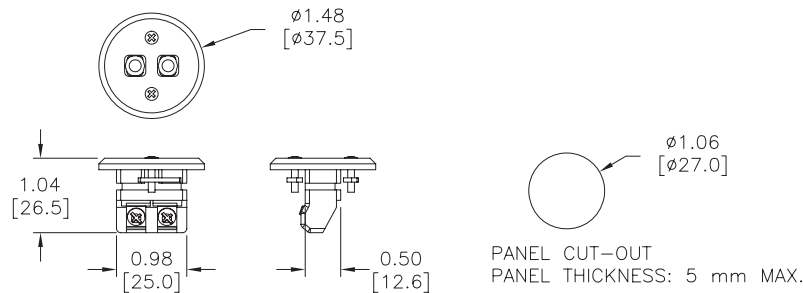

**THMJ, K, & T-MPJ**

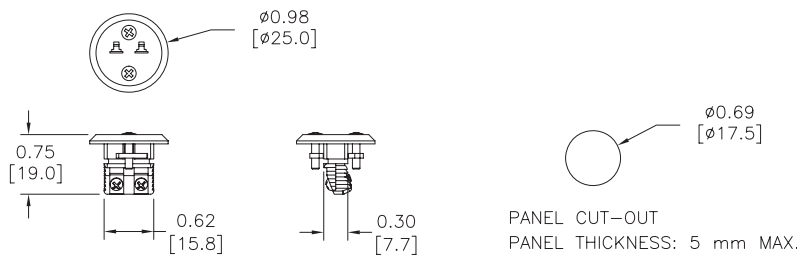

**RTD-SP**

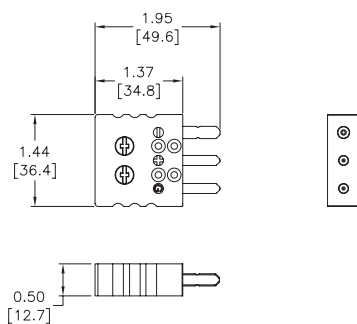

**RTD-SJ**

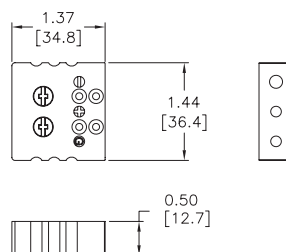

**NTC-SJ**

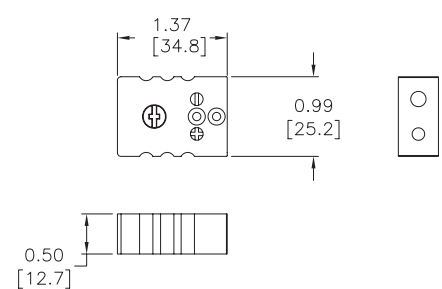

# pro<sup>ense</sup>® Thermocouple and RTD Connectors

**WCB-S**



**WCB-M**



**WCB-S Application**

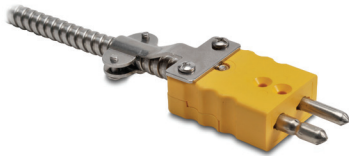

**WCB-M Application**



Thermocouple and RTD Connectors Accessories				
Part Number	Pcs/ Pkg	Wt(lb)	Price	Description
WCB-S	10	0.5	\$12.00	Wire / cable clamp bracket for use with standard thermocouple and RTD connectors.
WCB-M	10	0.5	\$12.00	Wire / cable clamp bracket for use with miniature thermocouple connectors.

## Dimensions

inches [mm]

**WCB-S**

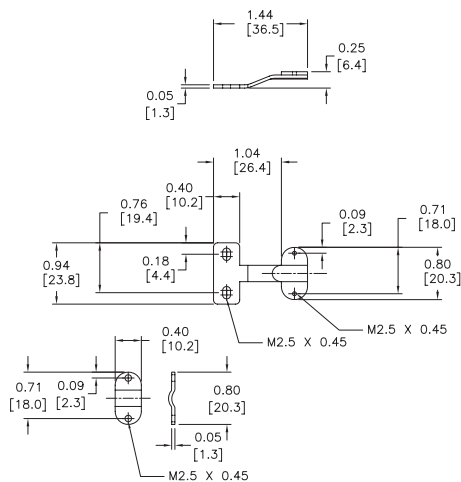

**WCB-M**

