

proSense® Thermocouple Bolt-On Ring Sensors

THMJ & K - B01L06-01

THMJ & K - B01L06-02



Overview

- Ideal thermocouple sensor for nozzles, extruder barrels, die heads, molds and many other surface sensing applications
- Type J or K thermocouple elements to meet many temperature sensing applications
- 316 SS or brass construction
- Grounded or ungrounded junctions
- 6 foot lead wires with stainless steel overbraid
- Made in the USA

Thermocouple Bolt-On Ring Sensors - Types J and K								
Part Number	Pcs/Pkg	Wt (lb)	Price	Type	Junction Type	Ring Material	Temperature Sensing Range	Mounting
THMJ-B01L06-01	1	0.4	\$22.00	J	Grounded	316 SS	0° to 482°C (32° to 900°F)	#6-#10 (4mm-5mm) screw or bolt size
THMK-B01L06-01			\$22.50	K				
THMJ-B01L06-02			\$33.50	J	Ungrounded	Brass		
THMK-B01L06-02			\$38.00	K				
THMJ-B02L06-01			\$21.50	J	Grounded	316 SS		#12, 1/4 to 5/16 inch (5mm - 8mm) screw or bolt size
THMK-B02L06-01			\$23.00	K				
THMJ-B02L06-02			\$34.50	J	Ungrounded	Brass		
THMK-B02L06-02			\$39.50	K				

Technical Specifications	
ASTM E230 Standard limits of Error	±2.2°C (±4.0°F) or 0.75%, whichever is greater
Response Time	2.9 seconds, 63.2% of a 25-77°C step change per method ASTM E839
Wiring	6 foot stranded 20 AWG wire leads with stripped ends, fiberglass insulation and stainless steel overbraid



Note: Check the chemical compatibility of the sensor's wetted parts with the medium to be measured.

Dimensions

inches [mm]

THMJ & K - B01L06-01

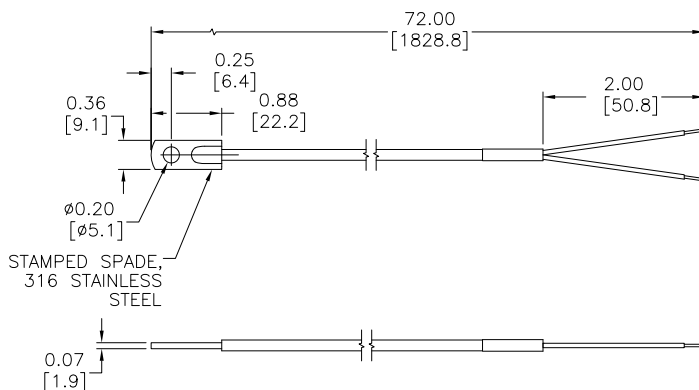

Wiring Information

Type J: (+) white (-) red
Type K: (+) yellow (-) red

- Must use thermocouple extension lead wire
- Observe polarity when making connections
- Do not use standard wire nuts



pro^{sense} Thermocouple Bolt-On Ring Sensors

Dimensions

inches [mm]

THMJ & K - B01L06-02

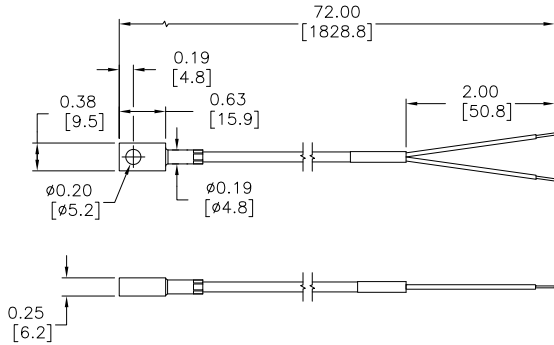

THMJ & K - B02L06-01

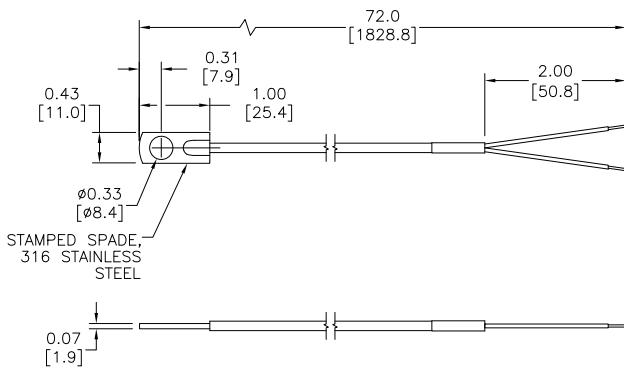

THMJ & K - B02L06-02

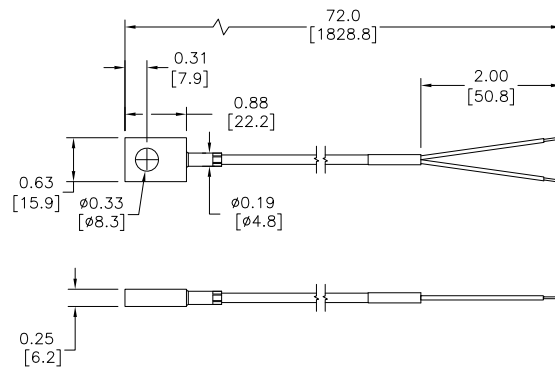

Wiring Information

Type J: (+) white (-) red
Type K: (+) yellow (-) red

- Must use thermocouple extension lead wire
- Observe polarity when making connections
- Do not use standard wire nuts

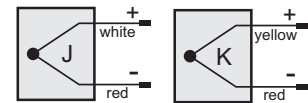

Accessories

Part No.	Description	Pcs/Pkg	Price
<u>THMJ-SP</u>	Thermocouple connector, Type J, standard round pin plug, maximum continuous temperature 400°F (200°C), glass filled thermoplastic black body, thermocouple material pins, 14 AWG maximum (2.0 mm) wire size	1	\$4.00
<u>THMJ-SJ</u>	Thermocouple connector, Type J, standard round pin jack, maximum continuous temperature 400°F (200°C), glass filled thermoplastic black body, thermocouple material pins, 14 AWG maximum (2.0 mm) wire size	1	\$5.25
<u>THMK-SP</u>	Thermocouple connector, Type K, standard round pin plug, maximum continuous temperature 400°F (200°C), glass filled thermoplastic yellow body, thermocouple material pins, 14 AWG maximum (2.0 mm) wire size	1	\$4.50
<u>THMK-SJ</u>	Thermocouple connector, Type K, standard round pin jack, maximum continuous temperature 400°F (200°C), glass filled thermoplastic yellow body, thermocouple material pins, 14 AWG maximum (2.0 mm) wire size	1	\$5.50
<u>THMJ-SPJ</u>	Thermocouple connector, Type J, standard round pin panel jack, maximum continuous temperature 400°F (200°C), glass filled thermoplastic black body, thermocouple material pins, 14 AWG (2.0 mm) maximum wire size	1	\$10.00
<u>THMK-SPJ</u>	Thermocouple connector, Type K, standard round pin panel jack, maximum continuous temperature 400°F (200°C), glass filled thermoplastic yellow body, thermocouple material pins, 14 AWG (2.0 mm) maximum wire size	1	\$10.00
<u>WCB-S</u>	Wire / cable clamp bracket for use with standard thermocouple and RTD connectors.	4	\$12.00

Note: Thermocouple extension lead wire available at www.automationdirect.com
 See end of section for full listing of accessories and dimension information.

THMJ-SJ



THMJ-SP



THMJ-SPJ



Thermocouple Connectors