

pro^osense[®] RTD Spade Sensors



RTD1-S02L06-01

Overview

- Ideal for surface temperature measurement.
- 100 ohm platinum RTD 3-wire element sealed in epoxy between two layers of polyimide tape.
- Class A accuracy
- Provided with an adhesive backing for easy attachment to many surfaces.
- Can be formed and secured to the outside of various size tubes, pipes, or nozzles.
- 6-foot lead wires with stainless steel overbraid.
- Made in the USA

RTD Spade Sensors						
Part Number	Pcs/Pkg	Wt (lb)	Price	Type	Spade Material	Temperature Sensing Range
<u>RTD1-S02L06-01</u>	1	0.25	\$52.00	PT 100, 3-wire	Polyimide w/ adhesive back	-40 to 204°C (-40 to 400°F)

Technical Specifications	
Sensing Element	Single 100Ω platinum (Pt 100), 3-wire; TCR = 0.00385 Ω/Ω/°C
Initial Accuracy	Class A ±[0.15 + 0.002 t] °C
Response Time	7 seconds, 63% of a 25 to 77°C step change (ASTM E1137)
Wiring	6 foot stranded 24 AWG wire leads with stripped ends, Kapton insulation and stainless steel overbraid

Dimensions

inches [mm]

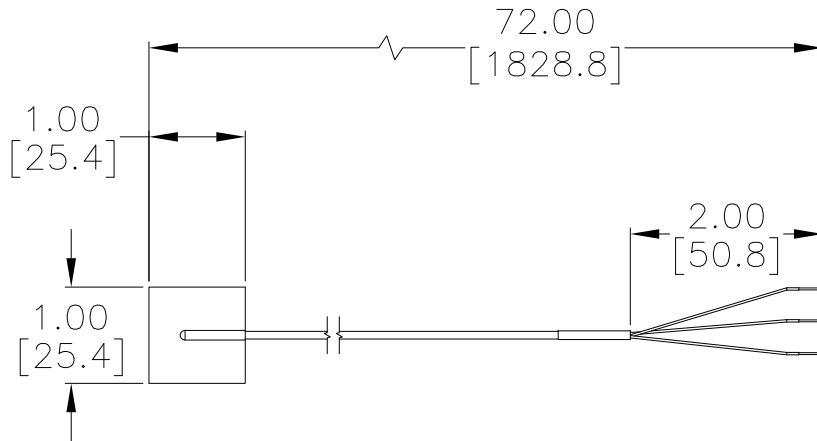

Wiring Information

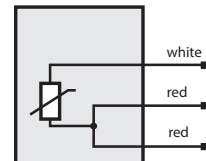

Accessories

Part No.	Description	Pcs/Pkg	Price
<u>RTD-SP</u>	RTD 3-pin connector, standard round pin plug, maximum continuous temperature 400°F (200°C), white body, copper pins, 14 AWG maximum (2.0 mm) wire size	1	\$9.00
<u>RTD-SJ</u>	RTD 3-pin connector, standard round pin jack, maximum continuous temperature 400°F (200°C), white body, copper pins, 14 AWG maximum (2.0 mm) wire size	1	\$11.50
<u>WCB-S</u>	Wire / cable clamp bracket for use with standard thermocouple and RTD connectors	4	\$12.00

Note: Full listing of accessories and dimension information available at the end of this section. RTD extension lead wire available at www.automationdirect.com