

pro^{sense}® RTD Probes with Hex Nipple

RTD1-HXXL01-01



CHSC-AL-1

CHTB-3

Accessories

Overview

- 100 ohm platinum RTD 3-wire element
- Class A accuracy
- 1/4" diameter, 316 sealed stainless steel sheath to protect against harsh environments
- RTD element encased in alumina powder insulation provides excellent vibration dampening and heat transfer
- 6", 12", or 18" probe length
- 1/2" x 1/2" NPT hex nipple allows easy replacement of existing probes and connection to a wiring junction box
- Made in the USA

RTD Probes with Hex Nipple								
Part Number	Pcs/Pkg	Wt (lb)	Price	Type	Probe Diameter (O.D.)	Probe Length	Temperature Sensing Range	Mounting
RTD1-H06L01-01	1	0.5	\$70.00	PT 100, 3-wire	1/4"	6"	-50 to 300°C (-58 to 572°F)	Integral 1/2" x 1/2" NPT Hex Nipple, 316 SS
RTD1-H12L01-01			\$75.00			12"		
RTD1-H18L01-01			\$81.00			18"		

Technical Specifications	
Sensing Element	Single 100Ω platinum (Pt 100), 3-wire; TCR = 0.00385 Ω/Ω/°C
Initial Accuracy	Class A ±[0.15 +0.002 t] °C
Probe	ø1/4", 316 stainless steel sheath, single RTD is embedded in alumina powder
Minimum Installation Depth	3" (76 mm)
Response Time	7 seconds, 63% of a 25 to 77°C step change (ASTM E1137)
Wiring	3-inch stranded 24 AWG wire leads with terminal pins, Kapton insulated



Note: Check the chemical compatibility of the sensor's wetted parts with the medium to be measured.

Dimensions

inches [mm]

RTD1-HXXL01-01

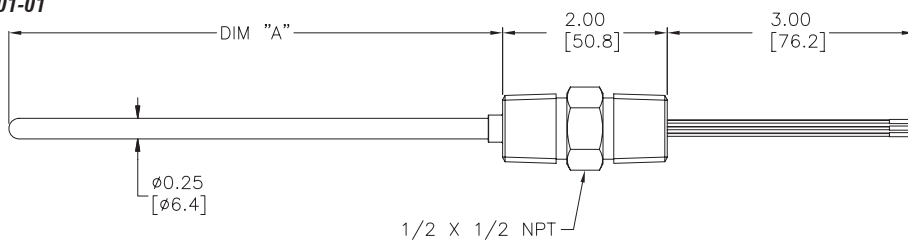

PART NUMBER	DIM "A"
RTD1-H06L01-01	6.00[152.4]
RTD1-H12L01-01	12.00[304.8]
RTD1-H18L01-01	18.00[457.2]

Wiring Information

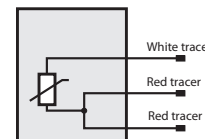

proSense® RTD Probes with Hex Nipple

Accessories

Part No.	Description	Pcs/Pkg	Price
CHSC-AL-1	ProSense general purpose screw cover connection head for temperature probes, die-cast aluminum, 1/2 inch NPT process opening, 3/4 inch NPT conduit opening, NEMA 4X, IP66 rated, graphite gasket, maximum temperature rating of 825°F (440°C). Order probe and terminal base separately.	1	\$23.00
CHTB-3	ProSense ceramic terminal base, three brass terminals with stainless steel screws, for use with ProSense temperature probe connection heads, two mounting screws included.	1	\$7.00

Note: Full listing of accessories available at the end of this section. RTD extension lead wire available at www.automationdirect.com

Dimensions

inches [mm]

CHSC-AL-1

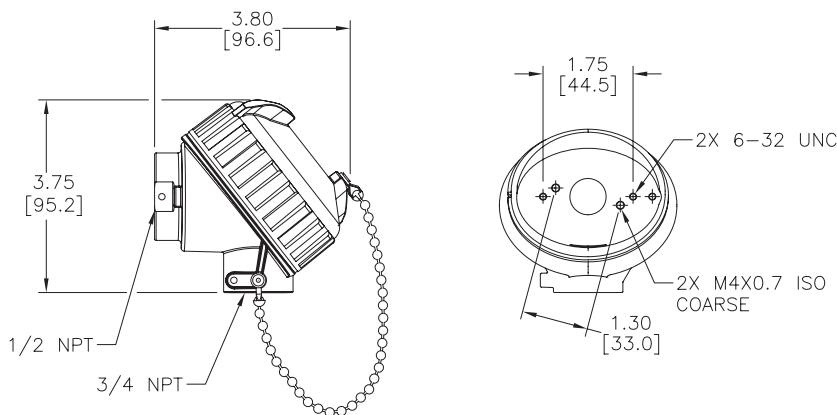

CHTB-3

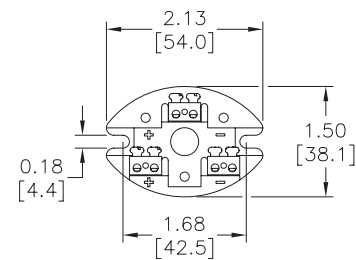

proSense® Thermowells



Overview

- Thermowells designed for use with ProSense thermocouple and RTD probes or ProSense Thermometers eliminate the need for a separate probe mounting fitting or adapter

RTDTW Series Thermowells

- Welded 316 stainless steel construction
- 1/2" NPT male process threads
- 3-year warranty

TW Series Thermowells

- Drilled bar stock one piece construction (no welds) from 304 or 316 stainless steel
- 1/2" and 3/4" NPT male process threads available
- Designs and fabrication comply with ASME B31.1 and boiler and pressure vessel codes
- Material complies with NACE MR 0175 / ISO 15156
- CRN registered for all Canadian provinces
- 1-year warranty





Thermowells for Thermocouples -TW Series

Part Number	Pcs/Pkg	Wt(lb)	Price	I.D.	Overall Length/"U" Length	Male Process Threads	Female Probe Threads	Wetted Material	Temperature/Pressure Rating	Use With Probe or Thermometer
TW025-01	1	0.4	\$29.50	0.26"	2-3/4" / 1"	1/2" NPT	1/2" NPT	304 SS	304SS: 1000°F max; 3400psi max 316SS: 1000°F max; 5200psi max	See Sensor Compatibility Table
TW025-03	1	0.4	\$34.50			1/2" NPT		316 SS		
TW04-01	1	0.5	\$34.00		4-1/4" / 2-1/2"	1/2" NPT		304 SS		
TW04-02	1	0.5	\$34.00			3/4" NPT		304 SS		
TW04-03	1	0.5	\$42.50			1/2" NPT		316 SS		
TW04-04	1	0.5	\$42.50			3/4" NPT		316 SS		
TW06-01	1	0.7	\$46.00		6-1/4" / 4-1/2"	1/2" NPT		304 SS		
TW06-02	1	0.7	\$46.00			3/4" NPT		304 SS		
TW06-03	1	0.7	\$54.00			1/2" NPT		316 SS		
TW06-04	1	0.7	\$54.00			3/4" NPT		316 SS		
TW09-01	1	1.0	\$67.00		9-1/4" / 7-1/2"	1/2" NPT		304 SS		
TW09-03	1	1.0	\$78.00			1/2" NPT		316 SS		
TW12-01	1	1.2	\$74.00		12-1/4" / 10-1/2"	1/2" NPT		304 SS		
TW12-02	1	1.2	\$74.00			3/4" NPT		304 SS		
TW12-03	1	1.2	\$93.00			1/2" NPT		316 SS		
TW12-04	1	1.2	\$93.00			3/4" NPT		316 SS		

pro^{sense} Thermowells

Thermowells for Thermocouples -RTDTW Series										
Part Number	Pcs/Pkg	Wt(lb)	Price	I.D.	Overall Length	Male Process Threads	Female Probe Threads	Wetted Material	Temperature/Pressure Rating	Use With
<u>RTDTW-06-010-50N</u>	1	0.10	\$39.00	7 mm (0.28")	113mm (4.4")	1/2" NPT	1/4" NPT	316 SS	600°F (315°C) max; 232 psi (16 bar) max	XTP-160-N40140F XTP-160-0300F XTP-160-0100C RTD0100-06-010-H CF06-25N fitting
<u>RTDTW-06-020-50N</u>	1	0.20	\$42.00		213mm (8.4")					XTP-260-N40140F XTP-260-0300F XTP-260-0100C RTD0100-06-020-H CF06-25N fitting
<u>RTDTW-06-030-50N</u>	1	0.30	\$46.00		313mm (12.3")					XTP-360-N40140F XTP-360-0300F XTP-360-0100C RTD0100-06-030-H CF06-25N fitting
<u>RTDTW-10-010-50N</u>	1	0.10	\$39.00	11 mm (0.43")	92mm (3.62")	1/2" NPT				RTD0100-10-010-H CF10-50N fitting
<u>RTDTW-10-030-50N</u>	1	0.22	Retired		292mm (11.48")					CF10-50N fitting

 Note: Check the chemical compatibility of the thermowell's wetted parts with the medium to be measured.

 Note: Response time will be slower when installed in a thermowell. Be sure to install the probe so that it contacts the end of the thermowell for faster response. Thermal compound may be used depending on application

Probe & Thermowell Assembly Example

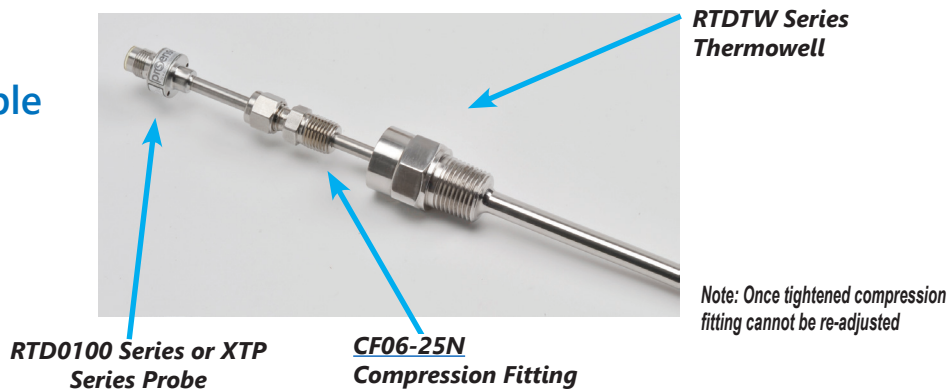

Spring-loaded Thermocouple or RTD and Thermowell Assembly Example

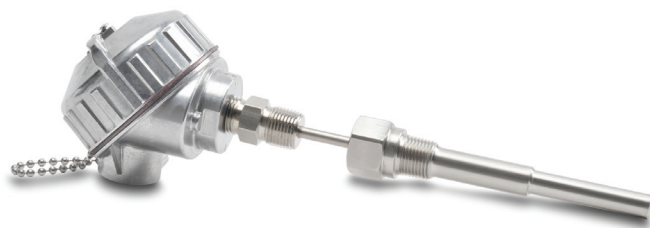

- Using spring-loaded probe design ensures positive tip contact with the bottom of the thermowell.
- Probes with hex nipple thread directly into thermowell. No additional probe mounting fittings are required.

proSense® Thermowells

Dimensions

inches [mm]

TW04-XX & TW025-XX

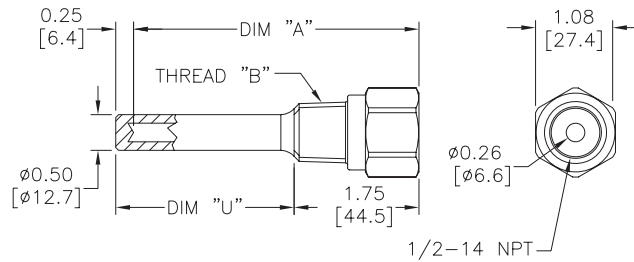

PART NUMBER	DIM "A"	THREAD "B" NPT	DIM "U"
TW025-01	2.50[63.5]	1/2-14	1.00[25.5]
TW025-03	2.50[63.5]	1/2-14	
TW04-01	4.00[101.6]	1/2-14	
TW04-02	4.00[101.6]	3/4-14	2.50[63.5]
TW04-03	4.00[101.6]	1/2-14	
TW04-04	4.00[101.6]	3/4-14	

Dimensions

inches [mm]

TW06-XX
TW09-XX
TW12-XX

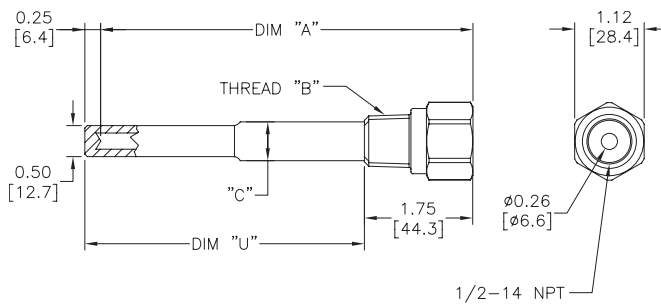

PART NUMBER	DIM "A"	THREAD "B" NPT	DIM "C"	DIM "U"
TW06-01	6.00[152.4]	1/2-14	0.63[15.9]	4.50[114.3]
TW06-02	6.00[152.4]	3/4-14	0.75[19.1]	
TW06-03	6.00[152.4]	1/2-14	0.63[15.9]	
TW06-04	6.00[152.4]	3/4-14	0.75[19.1]	7.50[190.5]
TW09-01	9.00[228.6]	1/2-14	0.63[15.9]	
TW09-03	9.00[228.6]	1/2-14	0.63[15.9]	
TW12-01	12.00[304.8]	1/2-14	0.63[15.9]	10.50[266.7]
TW12-02	12.00[304.8]	3/4-14	0.75[19.1]	
TW12-03	12.00[304.8]	1/2-14	0.63[15.9]	
TW12-04	12.00[304.8]	3/4-14	0.75[19.1]	

proSense® Thermowells

Dimensions

mm [inches]

RTDTW-06 Series

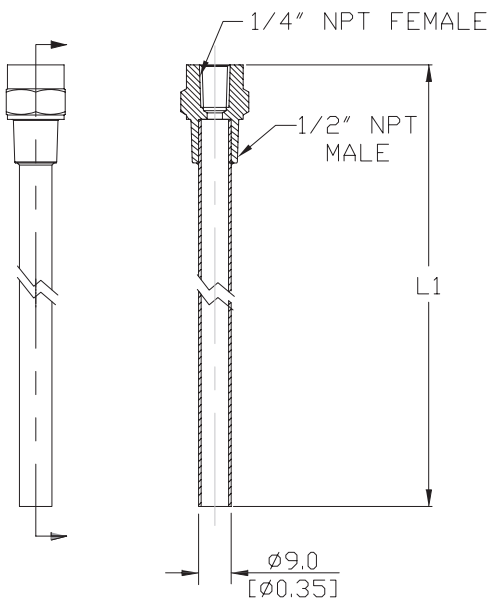

Part Number	L1
RTDTW-06-010-50N	113mm [4.4]
RTDTW-06-020-50N	213mm [8.4]
RTDTW-06-030-50N	313mm [12.3]

Torque threads to 40 lb-ft [54.23 Nm]*

* Torque values are for reference. Actual torque required for a proper seal of NPT threads is influenced by tolerance, sealant, lubricant, etc.

RTDTW-10 Series

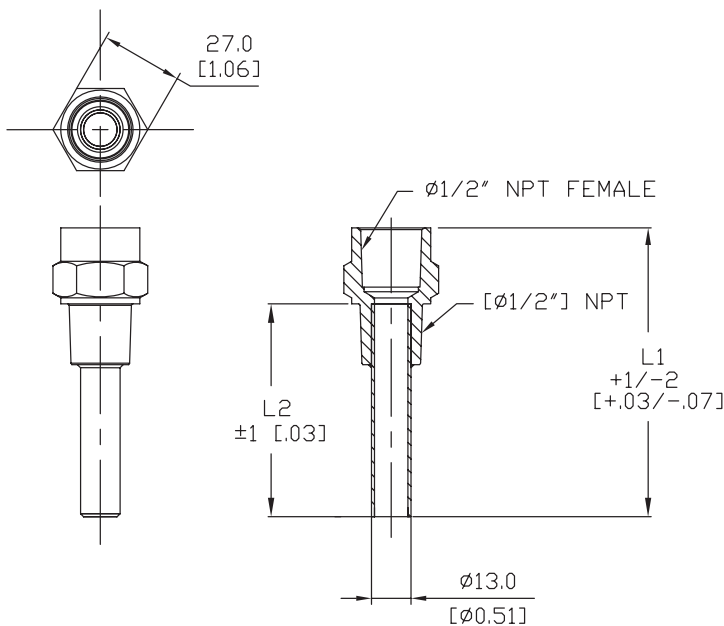









Part Number	L1	L2
RTDTW-10-030-50N	92mm [3.62]	70mm [2.75]
RTDTW-10-050-50N	292mm [11.48]	270mm [10.6]

Torque threads to 40 lb-ft [54.23 Nm]*

pro^{sense} Thermowells

TW Series Thermowells Sensor Compatibility Table

	Junction Box	Connection Head	Hex Nipple	Attached Plug	Lead Wire Transition	M12	Thermometer
Thermowell							
<u>TW025-01</u> <u>TW025-03</u>	-	-	-	-	-	-	T30-N40160-25C T30-0250-25C T30-50500-25C T30-150750-25C T50-N40160-25A T50-0250-25A T50-50500-25A T50-150750-25A
<u>TW04-01</u> <u>TW04-02</u> <u>TW04-03</u> <u>TW04-04</u>	NTC10K3-JB04-03	RTD1-C04-03 THMJ-C04-03 THMK-C04-03 NTC10K3-C04-03	RTD1-H04L01-02 THMJ-H04L01-02 THMK-H04L01-02 NTC10K3-H04L01-02	RTD1-P06-01 w/ CF14-50N THMJ-P06-02 w/ CF14-50N THMK-P06-02 w/ CF14-50N NTC10K3-P06-02 w/ CF14-50N	RTD1-T06L06-01 w/ CF14-50N THMJ-T06L06-02 w/ CF14-50N THMK-T06L06-02 w/ CF14-50N NTC10K3-T06L06-02 w/CF14-50N	RTD1-50N-100-H RTD0100-06-010-H w/CF14-50N XTP-160-N40140F w/CF14-50N XTP-160-0300F w/CF14-50N XTP-160-0100C w/CF14-50N XTP50N-100-N40140F XTP50N-100-0300F XTP50N-100-0100C ETS50N-100-1001 ETS50N-100-1003	T30-N40160-4C T30-0250-4C T30-50500-4C T30-150750-4C T50-N40160-4A T50-0250-4A T50-50500-4A T50-150750-4A
<u>TW06-01</u> <u>TW06-02</u> <u>TW06-03</u> <u>TW06-04</u>	NTC10K3-JB06-03	RTD1-C06-03 THMJ-C06-03 THMK-C06-03 NTC10K3-C06-03	RTD1-H06L01-02 THMJ-H06L01-02 THMK-H06L01-02 NTC10K3-H06L01-02	RTD1-P12-01 w/ CF14-50N THMJ-P12-02 w/ CF14-50N THMK-P12-02 w/ CF14-50N NTC10K3-P12-02 w/ CF14-50N	RTD1-T12L06-01 w/ CF14-50N THMJ-T12L06-02 w/ CF14-50N THMK-T12L06-02 w/ CF14-50N NTC10K3-T12L06-02 w/CF14-50N	RTD1-50N-150-H RTD0100-06-020-H w/CF14-50N XTP-260-N40140F w/CF14-50N XTP-260-0300F w/CF14-50N XTP-260-0100C w/CF14-50N XTP50N-150-N40140F XTP50N-150-0300F XTP50N-150-0100C ETS50N-150-1001 ETS50N-150-1003	T30-N40160-6C T30-0250-6C T30-50500-6C T30-150750-6C T50-N40160-6A T50-0250-6A T50-50500-6A T50-150750-6A
<u>TW09-01</u> <u>TW09-03</u>	-	-	-	-	-	-	T50-N40160-9A T50-0250-9A T50-50500-9A T50-150750-9A
<u>TW12-01</u> <u>TW12-02</u> <u>TW12-03</u> <u>TW12-04</u>	NTC10K3-JB12-03	RTD1-C12-03 THMJ-C12-03 THMK-C12-03 NTC10K3-C12-03	RTD1-H12L01-02 THMJ-H12L01-02 THMK-H12L01-02 NTC10K3-H12L01-02	RTD1-P18-01 w/ CF14-50N THMJ-P18-02 w/ CF14-50N THMK-P18-02 w/ CF14-50N NTC10K3-P18-02 w/ CF14-50N	RTD1-T18L06-01 w/ CF14-50N THMJ-T18L06-02 w/ CF14-50N THMK-T18L06-02 w/ CF14-50N NTC10K3-T18L06-02 w/CF14-50N	RTD0100-06-030-H w/CF14-50N XTP-360-N40140F w/CF14-50N XTP-360-0300F w/CF14-50N XTP-360-0100C w/CF14-50N	-

 *Note: Response time will be slower when installed in a thermowell. Be sure to install the probe so that it contacts the end of the thermowell for faster response. Thermal compound may be used depending on application.*

proSense® Thermowells Sanitary Clean-in-Place (CIP)



STW06-01

Overview

- Sanitary Clean-In-Place 3-A approved thermowells allow the use of standard temperature sensors in hygienic applications
- All wetted parts are 316 stainless steel
- Surface finish that meets or exceeds 32µin Ra
- Up to 1500/1200 psi (103/83 bar) at 70/250 °F (21/121 °C) dependent on clamp and seal assembly.
- Bore diameter of 0.260" to accommodate sensing probes with a 0.252" maximum diameter
- Probes with integral 1/2" male NPT process threads mount directly into the thermowell. Probes without threads require a compression fitting with 1/2" male NPT threads.



Thermowells Sanitary Clean-in-Place (CIP)									
Part Number	Pcs/Pkg	Wt(lb)	Price	I.D.	Overall Length/"U" Length	Process Connection	Female Probe Threads	Wetted Material	Use With
STW04-01	1	0.75	\$101.00	ø0.260	4-1/4" / 2-1/2"	1-1/2" tri-clamp	1/2" NPT	316 stainless steel	See Sensor Compatibility Table
STW06-01	1	0.88	\$108.00		6-1/4" / 4-1/2"				
STW12-01	1	1.13	\$150.00		12-1/4" / 10-1/2"				
STW04-02	1	0.75	\$112.00		4-1/4" / 2-1/2"	2" tri-clamp			
STW06-02	1	0.88	\$120.00		6-1/4" / 4-1/2"				
STW12-02	1	1.13	\$156.00		12-1/4" / 10-1/2"				



Note: Check the chemical compatibility of the thermowell's wetted parts with the medium to be measured.



Note: Response time will be slower when installed in a thermowell. Be sure to install the probe so that it contacts the end of the thermowell for faster response. Thermal compound may be used depending on application

Probe & Thermowell Assembly Example

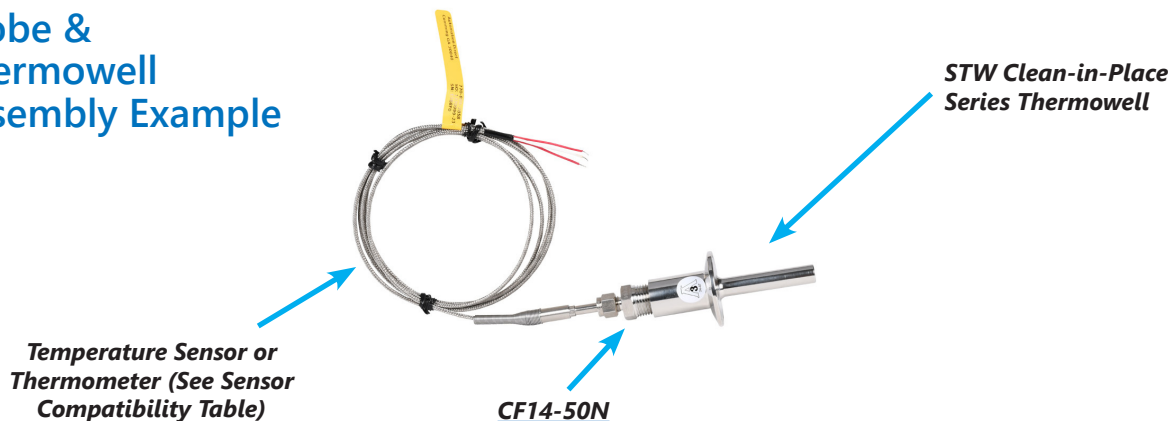

proSense® Thermowells Sanitary Clean-in-Place (CIP)

Spring-loaded Thermocouple or RTD and Thermowell Assembly Example



- Using spring-loaded probe design ensures positive tip contact with the bottom of the thermowell.
- Probes with hex nipple thread directly into thermowell. No additional probe mounting fittings are required.

Dimensions

inches [mm]

STWXX-XX

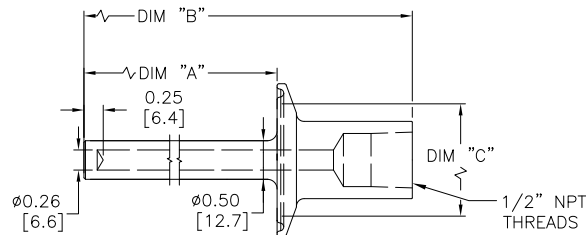









TABLE A

PART NUMBER	DIM "A"	DIM "B"	DIM "C"
STW04-01	2.50[63.5]	4.25[108.0]	1.50[38.1]
STW06-01	4.50[114.3]	6.25[158.8]	1.50[38.1]
STW12-01	10.50[266.8]	12.25[311.3]	1.50[38.1]
STW04-02	2.50[63.5]	4.25[108.0]	2.00[50.8]
STW06-02	4.50[114.3]	6.25[158.5]	2.00[50.8]
STW12-02	10.50[266.8]	12.25[311.3]	2.00[50.8]



Thermowells Sanitary Clean-in-Place (CIP)

Thermowells Sanitary Clean-in-Place (CIP) Sensors Compatibility Table							
	Junction Box	Connection Head Sensor	Hex Nipple Sensor	Attached Plug Sensor	Lead Wire Transition Sensor	M12 Sensor	Thermometer
Thermowell							
STW04-01	NTC10K3-JB04-03	RTD1-C04-03 THMJ-C04-03 THMK-C04-03 NTC10K3-C04-03	RTD1-H04L01-02 THMJ-H04L01-02 THMK-H04L01-02 NTC10K3-H04L01-02	RTD1-P06-01 w/ CF14-50N THMJ-P06-02 w/ CF14-50N THMK-P06-02 w/ CF14-50N NTC10K3-P06-02 w/ CF14-50N	RTD1-T06L06-01 w/ CF14-50N THMJ-T06L06-02 w/ CF14-50N THMK-T06L06-02 w/ CF14-50N	RTD1-50N-100-H RTD0100-06-010-H w/CF14-50N XTP-160-N40140F w/CF14-50N XTP-160-0300F w/CF14-50N XTP-160-0100C w/CF14-50N XTP50N-100-N40140F XTP50N-100-0300F XTP50N-100-0100C ETS50N-100-1001 ETS50N-100-1003	T30-N40160-4C T30-0250-4C T30-50500-4C T30-150750-4C T50-N40160-4A T50-0250-4A T50-50500-4A T50-150750-4A
STW06-01	NTC10K3-JB06-03	RTD1-C06-03 THMJ-C06-03 THMK-C06-03 NTC10K3-C06-03	RTD1-H06L01-02 THMJ-H06L01-02 THMK-H06L01-02 NTC10K3-H06L01-02	RTD1-P12-01 w/ CF14-50N THMJ-P12-02 w/ CF14-50N THMK-P12-02 w/ CF14-50N NTC10K3-P12-02 w/ CF14-50N	RTD1-T12L06-01 w/ CF14-50N THMJ-T12L06-02 w/ CF14-50N THMK-T12L06-02 w/ CF14-50N	RTD1-50N-150-H RTD0100-06-020-H w/CF14-50N XTP-260-N40140F w/CF14-50N XTP-260-0300F w/CF14-50N XTP-260-0100C w/CF14-50N XTP50N-150-N40140F XTP50N-150-0300F XTP50N-150-0100C ETS50N-150-1001 ETS50N-150-1003	T30-N40160-6C T30-0250-6C T30-50500-6C T30-150750-6C T50-N40160-6A T50-0250-6A T50-50500-6A T50-150750-6A
STW12-01	NTC10K3-JB12-03	RTD1-C12-03 THMJ-C12-03 THMK-C12-03 NTC10K3-C12-03	RTD1-H12L01-02 THMJ-H12L01-02 THMK-H12L01-02 NTC10K3-H12L01-02	RTD1-P18-01 w/ CF14-50N THMJ-P18-02 w/ CF14-50N THMK-P18-02 w/ CF14-50N NTC10K3-P18-02 w/ CF14-50N	RTD1-T18L06-01 w/ CF14-50N THMJ-T18L06-02 w/ CF14-50N THMK-T18L06-02 w/ CF14-50N	RTD0100-06-030-H w/CF14-50N XTP-360-N40140F w/CF14-50N XTP-360-0300F w/CF14-50N XTP-360-0100C w/CF14-50N	-
STW04-02	NTC10K3-JB04-03	RTD1-C04-03 THMJ-C04-03 THMK-C04-03 NTC10K3-C04-03	RTD1-H04L01-02 THMJ-H04L01-02 THMK-H04L01-02 NTC10K3-H04L01-02	RTD1-P06-01 w/ CF14-50N THMJ-P06-02 w/ CF14-50N THMK-P06-02 w/ CF14-50N NTC10K3-P06-02 w/ CF14-50N	RTD1-T06L06-01 w/ CF14-50N THMJ-T06L06-02 w/ CF14-50N THMK-T06L06-02 w/ CF14-50N	RTD1-50N-100-H RTD0100-06-010-H w/CF14-50N XTP-160-N40140F w/CF14-50N XTP-160-0300F w/CF14-50N XTP-160-0100C w/CF14-50N XTP50N-100-N40140F XTP50N-100-0300F XTP50N-100-0100C ETS50N-100-1001 ETS50N-100-1003	T30-N40160-4C T30-0250-4C T30-50500-4C T30-150750-4C T50-N40160-4A T50-0250-4A T50-50500-4A T50-150750-4A
STW06-02	NTC10K3-JB06-03	RTD1-C06-03 THMJ-C06-03 THMK-C06-03 NTC10K3-C06-03	RTD1-H06L01-02 THMJ-H06L01-02 THMK-H06L01-02 NTC10K3-H06L01-02	RTD1-P12-01 w/ CF14-50N THMJ-P12-02 w/ CF14-50N THMK-P12-02 w/ CF14-50N NTC10K3-P12-02 w/ CF14-50N	RTD1-T12L06-01 w/ CF14-50N THMJ-T12L06-02 w/ CF14-50N THMK-T12L06-02 w/ CF14-50N	RTD1-50N-150-H RTD0100-06-020-H w/CF14-50N XTP-260-N40140F w/CF14-50N XTP-260-0300F w/CF14-50N XTP-260-0100C w/CF14-50N XTP50N-150-N40140F XTP50N-150-0300F XTP50N-150-0100C ETS50N-150-1001 ETS50N-150-1003	T30-N40160-6C T30-0250-6C T30-50500-6C T30-150750-6C T50-N40160-6A T50-0250-6A T50-50500-6A T50-150750-6A
STW12-02	NTC10K3-JB12-03	RTD1-C12-03 THMJ-C12-03 THMK-C12-03 NTC10K3-C12-03	RTD1-H12L01-02 THMJ-H12L01-02 THMK-H12L01-02 NTC10K3-H12L01-02	RTD1-P18-01 w/ CF14-50N THMJ-P18-02 w/ CF14-50N THMK-P18-02 w/ CF14-50N NTC10K3-P18-02 w/ CF14-50N	RTD1-T18L06-01 w/ CF14-50N THMJ-T18L06-02 w/ CF14-50N THMK-T18L06-02 w/ CF14-50N	RTD0100-06-030-H w/CF14-50N XTP-360-N40140F w/CF14-50N XTP-360-0300F w/CF14-50N XTP-360-0100C w/CF14-50N	-

 Note: Response time will be slower when installed in a thermowell. Be sure to install the probe so that it contacts the end of the thermowell for faster response. Thermal compound may be used depending on application.

pro^{ense}® Connection Head and Ceramic Terminal Bases



Overview

- Cast aluminum NEMA 4X, IP66 screw cover head with captive gasket
- One turn cover removal & installation eliminates cross threading and saves time
- 3/4" NPT conduit opening with internal stop to prevent overtightening and installation damage
- Gripping ribs on cover edge
- Stainless steel cover chain
- Made in the USA

ProSense Aluminum Connection Head

Part Number	Description	Pcs/ Pkg	Wt(lb)	Price
CHSC-AL-1	ProSense general purpose screw cover connection head for temperature probes, die-cast aluminum, 1/2 NPT process opening, 3/4 NPT conduit opening, NEMA 4X, IP66 rated, graphite gasket, maximum temperature rating of 825°F (440°C)	1	1.0	\$23.00

Dimensions

inches [mm]

CHSC-AL-1

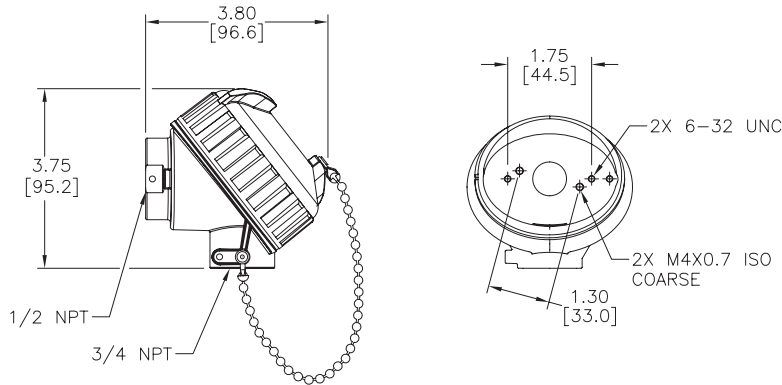

CHTB-2



CHTB-3

Overview

- Available with two terminals for thermocouples or three terminals for RTDs
- Fits **CHSC-AL-1** connection heads
- Ceramic base with brass terminals and stainless steel screws
- Accepts up to 12 AWG wire

Terminal Base for Connection Heads

Part Number	Description	Pcs/ Pkg	Wt(lb)	Price
CHTB-2	ProSense ceramic terminal base, two brass terminals with stainless steel screws, for use with ProSense temperature probe connection heads, two mounting screws included.	1	1.0	\$6.00
CHTB-3	ProSense ceramic terminal base, three brass terminals with stainless steel screws, for use with ProSense temperature probe connection heads, two mounting screws included.	1	1.0	\$7.00

Dimensions

inches [mm]

CHTB-2

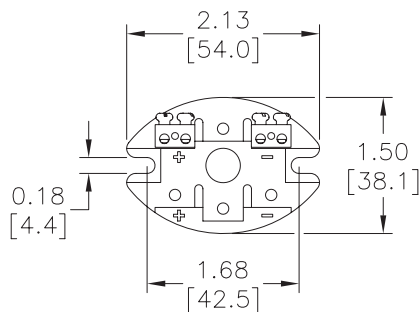

CHTB-3

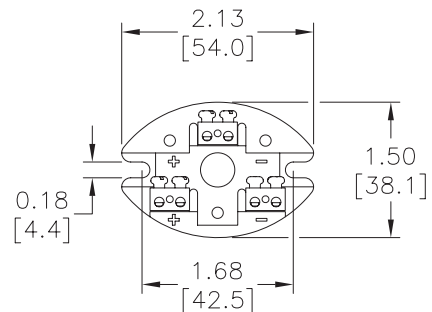

pro^{sense}® Compression Mounting Fittings for Temperature Probes

Compression Mounting Fittings for Temperature Probes				
Part Number	Description	Pcs/Pkg	Wt(lb)	Price
<u>BCF18-125N</u>	Compression fitting, brass, for 1/8 inch diameter temperature probes, 1/8 inch NPT male thread	1	0.5	\$3.25
<u>BCF14-125N</u>	Compression fitting, brass, for 1/4 inch diameter temperature probes, 1/8 inch NPT male thread	1	0.5	\$3.25
<u>BCF18-25N</u>	Compression fitting, brass, for 1/8 inch diameter temperature probes, 1/4 inch NPT male thread	1	0.5	\$4.25
<u>BCF14-25N</u>	Compression fitting, brass, for 1/4 inch diameter temperature probes, 1/4 inch NPT male thread	1	0.5	\$4.25
<u>BCF18-50N</u>	Compression fitting, brass, for 1/8 inch diameter temperature probes, 1/2 inch NPT male thread	1	0.5	\$6.00
<u>BCF14-50N</u>	Compression fitting, brass, for 1/4 inch diameter temperature probes, 1/2 inch NPT male thread	1	0.5	\$6.50
<u>CF18-125N</u>	Compression fitting, 316 stainless steel, for 1/8 inch diameter temperature probes, 1/8 inch NPT male thread	1	0.5	\$8.00
<u>CF14-125N</u>	Compression fitting, 316 stainless steel, for 1/4 inch diameter temperature probes, 1/8 inch NPT male thread	1	0.5	\$8.00
<u>CF18-25N</u>	Compression fitting, 316 stainless steel, for 1/8 inch diameter temperature probes, 1/4 inch NPT male thread	1	0.5	\$9.25
<u>CF14-25N</u>	Compression fitting, 316 stainless steel, for 1/4 inch diameter temperature probes, 1/4 inch NPT male thread	1	0.5	\$9.25
<u>CF18-50N</u>	Compression fitting, 316 stainless steel, for 1/8 inch diameter temperature probes, 1/2 inch NPT male thread	1	0.5	\$13.50
<u>CF14-50N</u>	Compression fitting, 316 stainless steel, for 1/4 inch diameter temperature probes, 1/2 inch NPT male thread	1	0.5	\$14.00
<u>CFTF-18**</u>	Teflon™ ferrule for brass or stainless steel compression fittings and 1/8 diameter temperature probes	5	0.5	\$7.25
<u>CFTF-14**</u>	Teflon ferrule for brass or stainless steel compression fittings and 1/4 diameter temperature probes	5	0.5	\$7.75
<u>CF06-25N</u>	1/4 NPT stainless steel compression fitting for 0.24 inch (6 mm) diameter RTD probe with M12 connector.	1	0.18	\$30.00
<u>CF10-50N</u>	1/2 NPT stainless steel compression fitting for 10 mm (0.4 inch) diameter RTD probe with M12 connector.	1	0.20	\$31.00
<u>CF18-BC</u>	Bayonet compression fitting, for 1/8" diameter probe sheath sensors	1	0.1	\$10.00
<u>BB125N-50N</u>	Reducing bushing, brass, 1/2 MNPT x 1/8 FNPT, hex head	1	0.1	\$5.75

BCF18-125N



BCF18-25N



BCF18-50N



BB125N-50N



Note: Check the chemical compatibility of the sensor's wetted parts with the medium to be measured.

* Working pressure of compression fitting should not exceed 500 psi. However we recommend any pressure application use a thermowell

** Teflon has a max working temperature range of -400 to 500°F (-240 to 260°C)

CFTF-14



CFTF-18



CF14-125N



CF14-50N

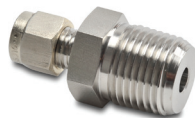

CF14-25N



CF18-BC



CF06-25N



CF10-50N



pro^{sense}® Compression Mounting Fittings for Temperature Probes

BCF14-125N



BCF14-25N



BCF14-50N



CF18-25N



CF18-50N



CF18-125N



Dimensions

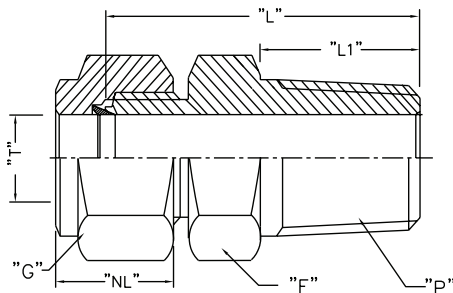

Note: All threaded connections should be hand tightened and then turned 1 to 2 full turns for proper sealing.

Actual torque required for a proper seal of NPT threads is influenced by tolerance, sealant, lubricant, etc.

ProSense Compression Fittings									
Part No.	Weight (lb)	Description	"T" Tube O.D.	"P" NPT(M)	"L" Body Length*	"L1" Thread Length**	"F" Body Hex**	"G" Nut Hex**	"NL" Nut Length**
BCF18-125N/CF18-125N	0.5	1/8" OD x 1/8" NPT(M)	0.128/0.132	1/8" NPT(M)	0.909"	0.393"	0.5"	0.433"	0.492"
BCF14-125N/CF14-125N	0.5	1/4" OD x 1/8" NPT(M)	0.253/0.257	1/8" NPT(M)	1.0"	0.393"	0.5"	0.559"	0.5"
BCF18-25N/CF18-25N	0.5	1/8" OD x 1/4" NPT(M)	0.128/0.132	1/4" NPT(M)	1.114"	0.551"	0.551"	0.433"	0.492"
BCF14-25N/CF14-25N	0.5	1/4" OD x 1/4" NPT(M)	0.253/0.257	1/4" NPT(M)	1.188"	0.551"	0.551"	0.559"	0.5"
BCF18-50N/CF18-50N	0.5	1/8" OD x 1/2" NPT(M)	0.128/0.132	1/2" NPT(M)	1.377"	0.748"	0.866"	0.433"	0.492"
BCF14-50N/CF14-50N	0.5	1/4" OD x 1/2" NPT(M)	0.253/0.257	1/2" NPT(M)	1.437"	0.748"	0.866"	0.559"	0.5"
CF06-25N	0.18	6 mm OD x 1/4" NPT(M)	0.236/0.240	1/4" NPT(M)	1.174"	0.59"	0.67"	0.55"	0.587"
CF10-50N	0.20	10 mm OD x 1/2" NPT(M)	0.394/0.399	1/2" NPT(M)	1.458"	0.55"	1.06"	0.75"	0.608"

Note: All dimensions are in inches

* w 0.07

** w 0.03

Note: Once the compression fitting has been fully tightened on the probe, the ferrule will be locked onto the probe and cannot be removed or reused.

*Working pressure of compression fitting should not exceed 500 psi. However we recommend any pressure application use a thermowell



Scan the QR Code or click to view the CF06 & CF10 Compression Fitting Installation Instructions



Bayonet Mounting Adapter for Temperature Sensors

Bayonet Mounting Adapter for Temperature Sensors					
Part Number	Description	Material	Pcs/Pkg	Wt(lb)	Price
<u>BA-078</u>	Bayonet adapter, 7/8 inch long, 7/16 inch outside diameter, 9/32 inch inside diameter, 1/8 inch MNPT	Stainless Steel (304)	1	0.5	\$1.75
<u>BA-100</u>	Bayonet adapter, 1 inch long, 7/16 inch outside diameter, 9/32 inch inside diameter, 1/8 inch MNPT		1	0.5	\$1.75
<u>BA-114</u>	Bayonet adapter, 1-1/4 inch long, 7/16 inch outside diameter, 9/32 inch inside diameter, 1/8 inch MNPT		1	0.5	\$2.25
<u>BA-112</u>	Bayonet adapter, 1-1/2 inch long, 7/16 inch outside diameter, 9/32 inch inside diameter, 1/8 inch MNPT		1	0.5	\$2.25
<u>BA-200</u>	Bayonet adapter, 2 inch long, 7/16 inch outside diameter, 9/32 inch inside diameter, 1/8 inch MNPT		1	0.5	\$2.50
<u>BA-212</u>	Bayonet adapter, 2-1/2 inch long, 7/16 inch outside diameter, 9/32 inch inside diameter, 1/8 inch MNPT		1	0.5	\$2.75
<u>BA-300</u>	Bayonet adapter, 3 inch long, 7/16 inch outside diameter, 9/32 inch inside diameter, 1/8 inch MNPT		1	0.5	\$3.00
<u>BA-312</u>	Bayonet adapter, 3-1/2 inch long, 7/16 inch outside diameter, 9/32 inch inside diameter, 1/8 inch MNPT		1	0.5	\$3.50
<u>CF18-BC</u>	Adjustable bayonet compression fitting, for 1/8" diameter probe sheath sensors			1	0.1
<u>BB125N-50N</u>	Reducing bushing, 1/2 MNPT x 1/8 FNPT, hex head	Brass	1	0.1	\$5.75

[BA-078](#)



[BA-100](#)



[BA-114](#)



Note: Check the chemical compatibility of the sensor's wetted parts with the medium to be measured.

[CF18-BC](#)



[BA-300](#)



[BA-112](#)



[BB125N-50N](#)



[BA-312](#)



[BA-200](#)



[BA-212](#)

