

proSense® RTD Probes with Connection Head

RTD1-CXX-01

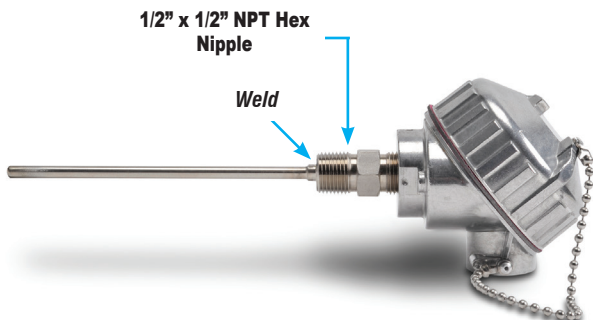

RTD1-CXX-02

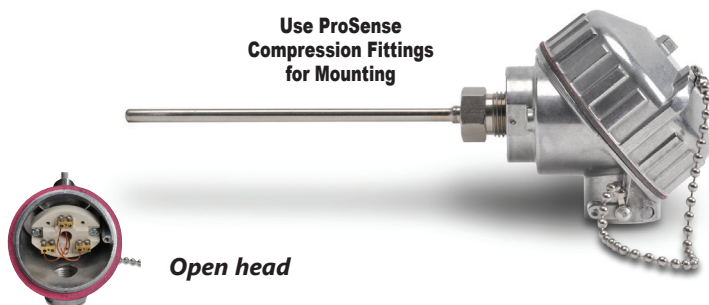

Overview

- Probe
 - 100 ohm platinum RTD 3-wire element
 - Class A accuracy
 - 1/4" diameter, 316 SS sealed sheath to protect against harsh environments
 - RTD element encased in alumina powder insulation provides excellent vibration dampening and heat transfer
 - 6", 12" or 18" probe length
- Connection Head
 - Cast aluminum NEMA 4X, IP66 screw cover head with gasket
 - One turn cover removal & installation eliminates cross threading and saves time
 - 3/4" NPT conduit opening with internal stop to prevent overtightening and installation damage
 - Gripping ribs on cover edge
 - Stainless steel cover chain
- Wiring
 - Ceramic terminal base
 - Brass terminals with stainless steel screws eliminate the need to wrap connections around screws
 - Elevated terminal block for easy wire termination
- Made in the USA

RTD Probes with Connection Head								
Part Number	Pcs/Pkg	Wt (lb)	Price	RTD Type	Probe Diameter (O.D.)	Probe Length	Temperature Sensing Range	Mounting
RTD1-C06-01	1	1.3	\$94.00	PT 100, 3-wire	1/4"	6"	-50 to 300°C (-58 to 572°F)	Integral 1/2" x 1/2" NPT Hex Nipple, 316 SS
RTD1-C12-01			\$97.00			12"		
RTD1-C18-01			\$100.00			18"		
RTD1-C06-02			\$87.00			6"		
RTD1-C12-02			\$89.00			12"		
RTD1-C18-02			\$93.00			18"		

Technical Specifications	
Sensing Element	Single 100Ω platinum (Pt 100), 3-wire; TCR = 0.00385 Ω/Ω/°C
Initial Accuracy	Class A ±[0.15 + 0.002 t] °C
Probe	ø1/4", 316 stainless steel sheath, single RTD is embedded in alumina powder
Minimum Installation Depth	3" (76 mm)
Connection Head	Die-cast aluminum, screw cover with stainless steel chain, compressed graphite gasket, NEMA 4X, IP66, 3/4" NPT conduit opening, max temp. 400°F (204°C)
Response Time	7 seconds, 63% of a 25 to 77°C step change (ASTM E1137)
Wiring	Ceramic terminal base with brass terminals and stainless steel screws (recommended tightening torque 3-4 lb-in)



Note: Check the chemical compatibility of the sensor's wetted parts with the medium to be measured.

prosense® RTD Probes with Connection Head

Dimensions

inches [mm]

RTD1-CXX-01

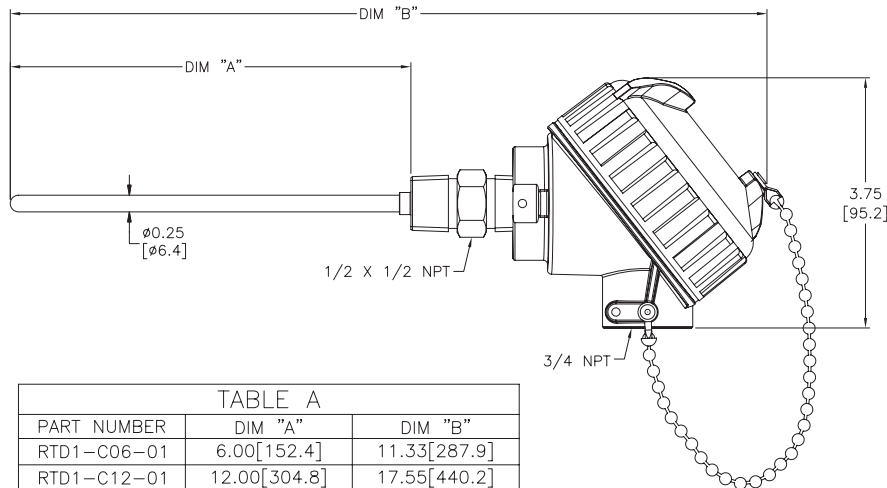
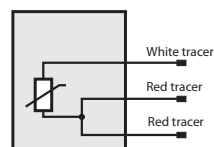
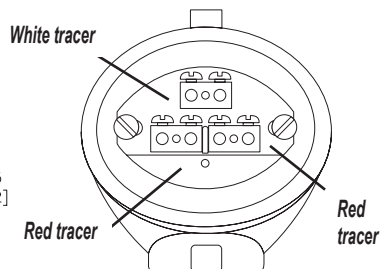

TABLE A		
PART NUMBER	DIM "A"	DIM "B"
RTD1-C06-01	6.00[152.4]	11.33[287.9]
RTD1-C12-01	12.00[304.8]	17.55[440.2]
RTD1-C18-01	18.00[457.2]	23.33[592.6]

Wiring Information



- Ignore polarity marks on terminal base
- Recommended screw terminal tightening torque 3-4 lb-in

RTD1-CXX-02

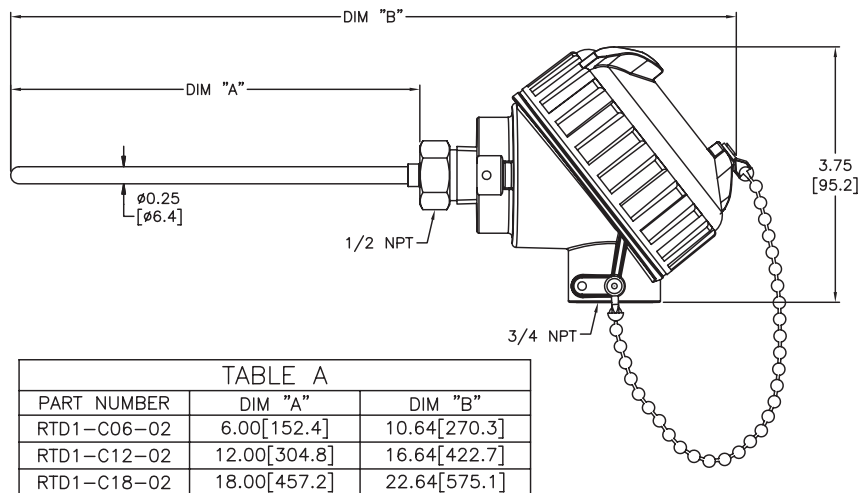

TABLE A		
PART NUMBER	DIM "A"	DIM "B"
RTD1-C06-02	6.00[152.4]	10.64[270.3]
RTD1-C12-02	12.00[304.8]	16.64[422.7]
RTD1-C18-02	18.00[457.2]	22.64[575.1]

Accessories

Part No.	Description	Pcs/Pkg	Price
BCF14-125N	Compression fitting, brass, for 1/4 inch diameter temperature probes, 1/8 inch NPT male thread	1	\$3.25
BCF14-25N	Compression fitting, brass, for 1/4 inch diameter temperature probes, 1/4 inch NPT male thread	1	\$4.25
BCF14-50N	Compression fitting, brass, for 1/4 inch diameter temperature probes, 1/2 inch NPT male thread	1	\$6.50
CF14-125N	Compression fitting, 316 stainless steel, for 1/4 inch diameter temperature probes, 1/8 inch NPT male thread	1	\$8.00
CF14-25N	Compression fitting, 316 stainless steel, for 1/4 inch diameter temperature probes, 1/4 inch NPT male thread	1	\$9.25
CF14-50N	Compression fitting, 316 stainless steel, for 1/4 inch diameter temperature probes, 1/2 inch NPT male thread	1	\$14.00
CFTF-14	Teflon ferrule for brass or stainless steel compression fittings and 1/4 diameter temperature probes	5	\$7.75

Note: RTD extension lead wire available at www.automationdirect.com
See end of section for full listing of accessories and dimension information.

pro^{sense}® Compression Mounting Fittings for Temperature Probes

Compression Mounting Fittings for Temperature Probes				
Part Number	Description	Pcs/Pkg	Wt(lb)	Price
<u>BCF18-125N</u>	Compression fitting, brass, for 1/8 inch diameter temperature probes, 1/8 inch NPT male thread	1	0.5	\$3.25
<u>BCF14-125N</u>	Compression fitting, brass, for 1/4 inch diameter temperature probes, 1/8 inch NPT male thread	1	0.5	\$3.25
<u>BCF18-25N</u>	Compression fitting, brass, for 1/8 inch diameter temperature probes, 1/4 inch NPT male thread	1	0.5	\$4.25
<u>BCF14-25N</u>	Compression fitting, brass, for 1/4 inch diameter temperature probes, 1/4 inch NPT male thread	1	0.5	\$4.25
<u>BCF18-50N</u>	Compression fitting, brass, for 1/8 inch diameter temperature probes, 1/2 inch NPT male thread	1	0.5	\$6.00
<u>BCF14-50N</u>	Compression fitting, brass, for 1/4 inch diameter temperature probes, 1/2 inch NPT male thread	1	0.5	\$6.50
<u>CF18-125N</u>	Compression fitting, 316 stainless steel, for 1/8 inch diameter temperature probes, 1/8 inch NPT male thread	1	0.5	\$8.00
<u>CF14-125N</u>	Compression fitting, 316 stainless steel, for 1/4 inch diameter temperature probes, 1/8 inch NPT male thread	1	0.5	\$8.00
<u>CF18-25N</u>	Compression fitting, 316 stainless steel, for 1/8 inch diameter temperature probes, 1/4 inch NPT male thread	1	0.5	\$9.25
<u>CF14-25N</u>	Compression fitting, 316 stainless steel, for 1/4 inch diameter temperature probes, 1/4 inch NPT male thread	1	0.5	\$9.25
<u>CF18-50N</u>	Compression fitting, 316 stainless steel, for 1/8 inch diameter temperature probes, 1/2 inch NPT male thread	1	0.5	\$13.50
<u>CF14-50N</u>	Compression fitting, 316 stainless steel, for 1/4 inch diameter temperature probes, 1/2 inch NPT male thread	1	0.5	\$14.00
<u>CFTF-18**</u>	Teflon™ ferrule for brass or stainless steel compression fittings and 1/8 diameter temperature probes	5	0.5	\$7.25
<u>CFTF-14**</u>	Teflon ferrule for brass or stainless steel compression fittings and 1/4 diameter temperature probes	5	0.5	\$7.75
<u>CF06-25N</u>	1/4 NPT stainless steel compression fitting for 0.24 inch (6 mm) diameter RTD probe with M12 connector.	1	0.18	\$30.00
<u>CF10-50N</u>	1/2 NPT stainless steel compression fitting for 10 mm (0.4 inch) diameter RTD probe with M12 connector.	1	0.20	\$31.00
<u>CF18-BC</u>	Bayonet compression fitting, for 1/8" diameter probe sheath sensors	1	0.1	\$10.00
<u>BB125N-50N</u>	Reducing bushing, brass, 1/2 MNPT x 1/8 FNPT, hex head	1	0.1	\$5.75

[BCF18-125N](#)



[BCF18-25N](#)



[BCF18-50N](#)



[BB125N-50N](#)



Note: Check the chemical compatibility of the sensor's wetted parts with the medium to be measured.

* Working pressure of compression fitting should not exceed 500 psi. However we recommend any pressure application use a thermowell

** Teflon has a max working temperature range of -400 to 500°F (-240 to 260°C)

[CFTF-14](#)



[CFTF-18](#)



[CF14-125N](#)



[CF14-50N](#)

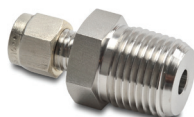

[CF14-25N](#)



[CF18-BC](#)



[CF06-25N](#)



[CF10-50N](#)



pro^{sense}® Compression Mounting Fittings for Temperature Probes

BCF14-125N**BCF14-25N****BCF14-50N****CF18-25N****CF18-50N****CF18-125N**

Dimensions

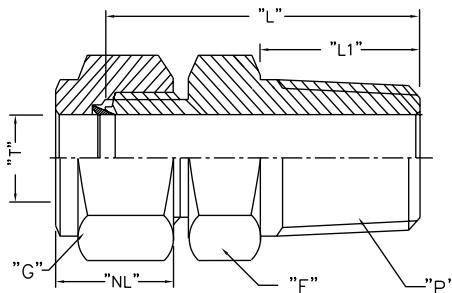

Note: All threaded connections should be hand tightened and then turned 1 to 2 full turns for proper sealing.

Actual torque required for a proper seal of NPT threads is influenced by tolerance, sealant, lubricant, etc.

ProSense Compression Fittings									
Part No.	Weight (lb)	Description	"T" Tube O.D.	"P" NPT(M)	"L" Body Length*	"L1" Thread Length**	"F" Body Hex**	"G" Nut Hex**	"NL" Nut Length**
BCF18-125N/ CF18-125N	0.5	1/8" OD x 1/8" NPT(M)	0.128/0.132	1/8" NPT(M)	0.909"	0.393"	0.5"	0.433"	0.492"
BCF14-125N/ CF14-125N	0.5	1/4" OD x 1/8" NPT(M)	0.253/0.257	1/8" NPT(M)	1.0"	0.393"	0.5"	0.559"	0.5"
BCF18-25N/ CF18-25N	0.5	1/8" OD x 1/4" NPT(M)	0.128/0.132	1/4" NPT(M)	1.114"	0.551"	0.551"	0.433"	0.492"
BCF14-25N/ CF14-25N	0.5	1/4" OD x 1/4" NPT(M)	0.253/0.257	1/4" NPT(M)	1.188"	0.551"	0.551"	0.559"	0.5"
BCF18-50N/ CF18-50N	0.5	1/8" OD x 1/2" NPT(M)	0.128/0.132	1/2" NPT(M)	1.377"	0.748"	0.866"	0.433"	0.492"
BCF14-50N/ CF14-50N	0.5	1/4" OD x 1/2" NPT(M)	0.253/0.257	1/2" NPT(M)	1.437"	0.748"	0.866"	0.559"	0.5"
CF06-25N	0.18	6 mm OD x 1/4" NPT(M)	0.236/0.240	1/4" NPT(M)	1.174"	0.59"	0.67"	0.55"	0.587"
CF10-50N	0.20	10 mm OD x 1/2" NPT(M)	0.394/0.399	1/2" NPT(M)	1.458"	0.55"	1.06"	0.75"	0.608"

Note: All dimensions are in inches

* w 0.07

** w 0.03

Note: Once the compression fitting has been fully tightened on the probe, the ferrule will be locked onto the probe and cannot be removed or reused.

*Working pressure of compression fitting should not exceed 500 psi. However we recommend any pressure application use a thermowell



Scan the QR Code or click to view the CF06 & CF10 Compression Fitting Installation Instructions



Bayonet Mounting Adapter for Temperature Sensors

Bayonet Mounting Adapter for Temperature Sensors					
Part Number	Description	Material	Pcs/Pkg	Wt(lb)	Price
BA-078	Bayonet adapter, 7/8 inch long, 7/16 inch outside diameter, 9/32 inch inside diameter, 1/8 inch MNPT	Stainless Steel (304)	1	0.5	\$1.75
BA-100	Bayonet adapter, 1 inch long, 7/16 inch outside diameter, 9/32 inch inside diameter, 1/8 inch MNPT		1	0.5	\$1.75
BA-114	Bayonet adapter, 1-1/4 inch long, 7/16 inch outside diameter, 9/32 inch inside diameter, 1/8 inch MNPT		1	0.5	\$2.25
BA-112	Bayonet adapter, 1-1/2 inch long, 7/16 inch outside diameter, 9/32 inch inside diameter, 1/8 inch MNPT		1	0.5	\$2.25
BA-200	Bayonet adapter, 2 inch long, 7/16 inch outside diameter, 9/32 inch inside diameter, 1/8 inch MNPT		1	0.5	\$2.50
BA-212	Bayonet adapter, 2-1/2 inch long, 7/16 inch outside diameter, 9/32 inch inside diameter, 1/8 inch MNPT		1	0.5	\$2.75
BA-300	Bayonet adapter, 3 inch long, 7/16 inch outside diameter, 9/32 inch inside diameter, 1/8 inch MNPT		1	0.5	\$3.00
BA-312	Bayonet adapter, 3-1/2 inch long, 7/16 inch outside diameter, 9/32 inch inside diameter, 1/8 inch MNPT		1	0.5	\$3.50
CF18-BC	Adjustable bayonet compression fitting, for 1/8" diameter probe sheath sensors		Brass	1	0.1
BB125N-50N	Reducing bushing, 1/2 MNPT x 1/8 FNPT, hex head	1		0.1	\$5.75

BA-078



BA-100



BA-114



Note: Check the chemical compatibility of the sensor's wetted parts with the medium to be measured.

CF18-BC



BA-300



BA-112



BB125N-50N



BA-312



BA-200



BA-212



ProSense® Pipe Clamp Adapters

**PCA-300**

Overview

- For use with ProSense adjustable immersion thermocouple and RTD sensors
- Available in adjustable diameters from 11/16 to 7 inches
- Provides an easy means of sensing temperature on the outside of a pipe

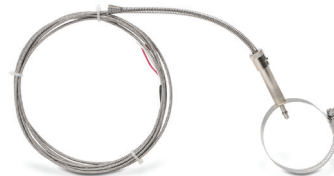

Shown with optional adjustable immersion sensor

Pipe Clamp Adapters for ProSense Adjustable Immersion Sensors

Part Number	Description	Pcs/ Pkg	Wt(lb)	Price
PCA-125	ProSense pipe clamp adapter, 11/16 to 1-1/4 inch adjustable diameter, 2-inch attached bayonet adapter with 7/16 inch outside diameter and 9/32 inch inside diameter. Use with ProSense adjustable immersion sensors.	1	0.1	\$17.50
PCA-200	ProSense pipe clamp adapter with 1-1/16 to 2 inch adjustable diameter, 2-inch attached bayonet adapter with 7/16 inch outside diameter and 9/32 inch inside diameter. Use with ProSense adjustable immersion sensors.	1	0.1	\$18.00
PCA-300	ProSense pipe clamp adapter with 2-1/16 to 3 inch adjustable diameter, 2-inch attached bayonet adapter with 7/16 inch outside diameter and 9/32 inch inside diameter. Use with ProSense adjustable immersion sensors.	1	0.1	\$20.00
PCA-425	ProSense pipe clamp adapter with 3-5/16 to 4-1/4 inch adjustable diameter, 2-inch attached bayonet adapter with 7/16 inch outside diameter and 9/32 inch inside diameter. Use with ProSense adjustable immersion sensors.	1	0.1	\$22.50
PCA-500	ProSense pipe clamp adapter with 4-1/8 to 7 inch adjustable diameter, 2-inch attached bayonet adapter with 7/16 inch outside diameter and 9/32 inch inside diameter. Use with ProSense adjustable immersion sensors.	1	0.1	\$21.00

Dimensions

inches [mm]

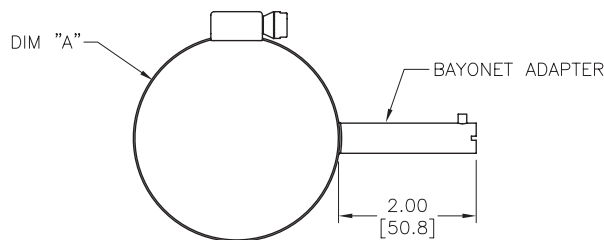

TABLE A

PART NUMBER	DIM "A"	FITS PIPE SIZES
PCA-125	ø0.68–1.25 [ø17.2–31.7]	1/2 TO 3/4 NPS
PCA-200	ø1.06–2.00 [ø26.9–50.8]	1 TO 1-1/2 NPS
PCA-300	ø2.06–3.00 [ø52.3–76.2]	2 TO 2-1/2 NPS
PCA-425	ø3.31–4.25 [ø84.1–108.0]	3 TO 3-1/2 NPS
PCA-500	ø4.12–7.00 [ø104.6–177.8]	4 TO 6 NPS

proSense® Thermocouple, RTD, and Thermistor Connectors

Overview

- Glass-filled high quality thermoplastic body with original thermocouple material pins and spring-loaded inserts
- Polarized pins
- Molded barriers prevent short circuit
- Captive central cover screw for easy assembly
- Easy wire connection pressure plate
- construction
- Stainless steel screws with combination head (Slotted and Phillips)
- 3-pin standard connectors have a third pin for ground or continuous shield, or for 3-wire RTDs

Thermocouple, RTD, and Thermistor Connectors												
Part Number	Pcs/ Pkg	Wt(lb)	Price	Sensor Type	Connector Type	Temperature Rating	Body Color	Wire Size	Wire Cable Clamp Bracket			
THMJ-SP	1	0.5	\$4.00	J	Standard round pin plug	Max continuous 400°F (200°C)	Black	32 AWG (0.2 mm) to 14 AWG maximum (2.0 mm)	WCB-S			
THMJ-SJ	1	0.5	\$5.25		Standard round pin jack					-		
THMJ-SPJ	1	0.5	\$10.00		Standard round direct mount jack							
THMJ-MP	1	0.5	\$3.75		Miniature flat pin plug				40 AWG (0.08 mm) to 20 AWG maximum (0.8 mm)		WCB-M	
THMJ-MJ	1	0.5	\$4.25		Miniature flat pin jack							
THMJ-MPJ	1	0.5	\$6.75		Miniature round direct mount jack							
THMK-SP	1	0.5	\$4.50	K	Standard round pin plug		Max continuous 662°F (350°C)	Yellow	32 AWG (0.2 mm) to 14 AWG maximum (2.0 mm)	WCB-S		
THMK-SJ	1	0.5	\$5.50		Standard round pin jack						-	
THMK-SPJ	1	0.5	\$10.00		Standard round direct mount jack							
THMK-MP	1	0.5	\$4.00		Miniature flat pin plug					40 AWG (0.08 mm) to 20 AWG maximum (0.8 mm)		WCB-M
THMK-MJ	1	0.5	\$4.25		Miniature flat pin jack							
THMK-MPJ	1	0.5	\$7.50		Miniature round direct mount jack							
THMK-HSP	1	0.5	\$13.00	Standard hi-temp round pin plug	Max continuous 400°F (200°C)	Brown		32 AWG (0.2 mm) to 14 AWG maximum (2.0 mm)	WCB-S			
THMK-HSJ	1	0.5	\$15.00							Standard hi-temp round pin jack		
THMT-SP	1	0.5	\$4.25	T		Standard round pin plug		Max continuous 400°F (200°C)	Blue	40 AWG (0.08 mm) to 20 AWG maximum (0.8 mm)	WCB-M	
THMT-SJ	1	0.5	\$5.75			Standard round pin jack						-
THMT-SPJ	1	0.5	\$9.50			Standard round direct mount jack						
THMT-MP	1	0.5	\$4.00			Miniature flat pin plug					40 AWG (0.08 mm) to 20 AWG maximum (0.8 mm)	
THMT-MJ	1	0.5	\$4.50			Miniature flat pin jack						
THMT-MPJ	1	0.5	\$8.00			Miniature round direct mount jack						
RTD-SP	1	0.5	\$9.00	RTD		Standard round pin plug	White		32 AWG (0.2 mm) to 14 AWG maximum (2.0 mm)	WCB-S		
RTD-SJ	1	0.5	\$11.50			Standard round pin jack						
NTC-SJ	1	0.5	\$6.75	Thermistor		Standard round pin jack						

[THMT-SP](#)



[THMT-SJ](#)



[THMK-SP](#)



[THMK-SJ](#)



[THMK-MP](#)



[THMJ-MJ](#)



[THMT-SPJ](#)



[THMT-MPJ](#)



[RTD-SP](#)

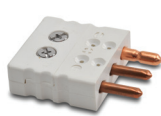

[RTD-SJ](#)



[THMK-HSP](#)



[THMK-HSJ](#)



[NTC-SJ](#)



proSense® Thermocouple, RTD, and Thermistor Connectors

Dimensions

inches [mm]

THMJ, K, T, & H-SP

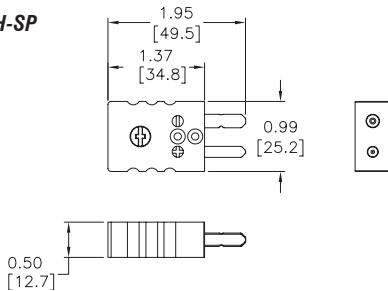

THMJ, K, T, & H-SJ

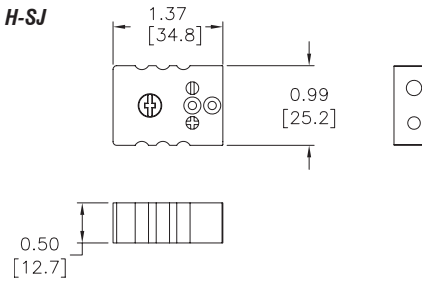

THMJ, K, & T-MP

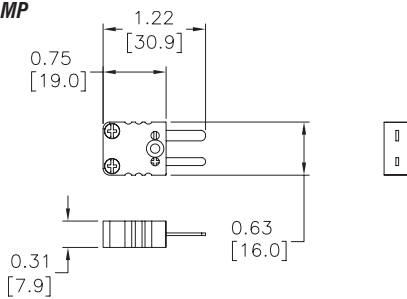

THMJ, K, & T-MJ

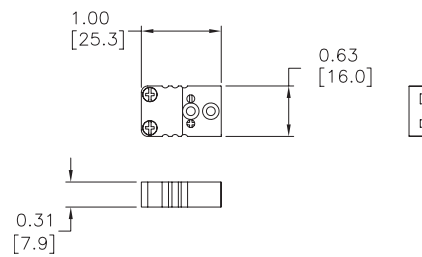

THMJ, K, & T-SPJ

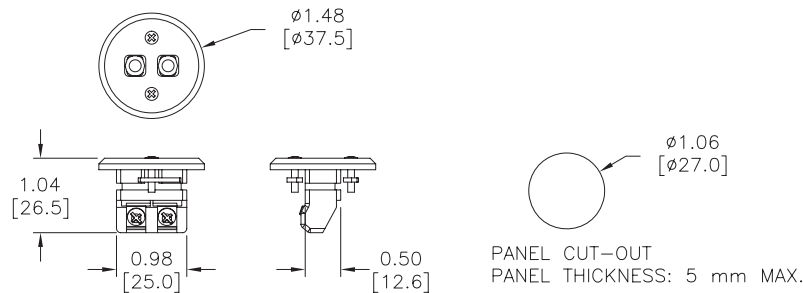

THMJ, K, & T-MPJ

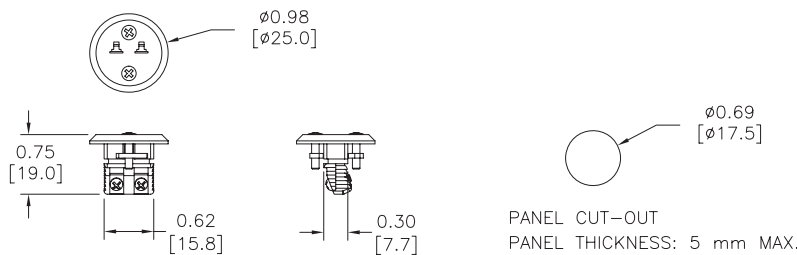

RTD-SP

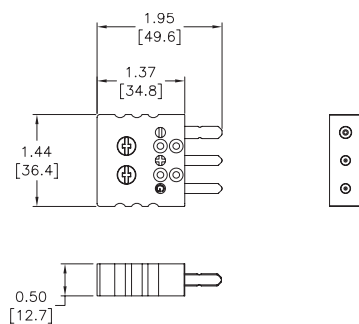

RTD-SJ

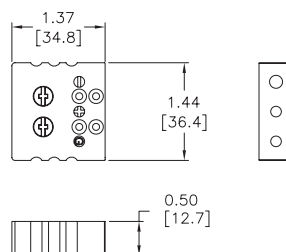

NTC-SJ

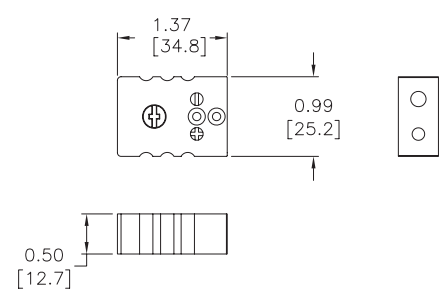

pro^{ense}® Thermocouple and RTD Connectors

WCB-S



WCB-M



WCB-S Application



WCB-M Application



Thermocouple and RTD Connectors Accessories				
Part Number	Pcs/ Pkg	Wt(lb)	Price	Description
WCB-S	10	0.5	\$12.00	Wire / cable clamp bracket for use with standard thermocouple and RTD connectors.
WCB-M	10	0.5	\$12.00	Wire / cable clamp bracket for use with miniature thermocouple connectors.

Dimensions

inches [mm]

WCB-S

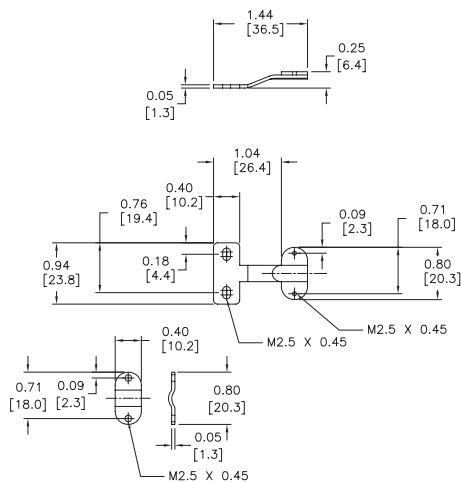

WCB-M

