

# proSense® RTD Probes with Connection Head

RTD1-CXX-01

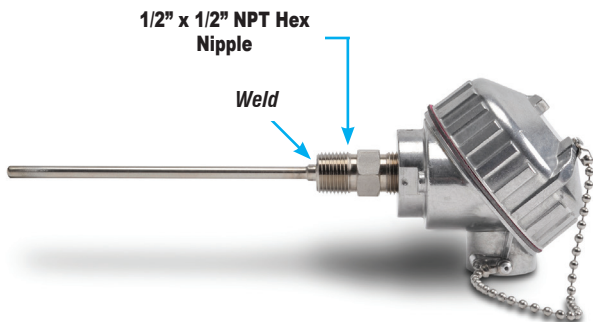

RTD1-CXX-02

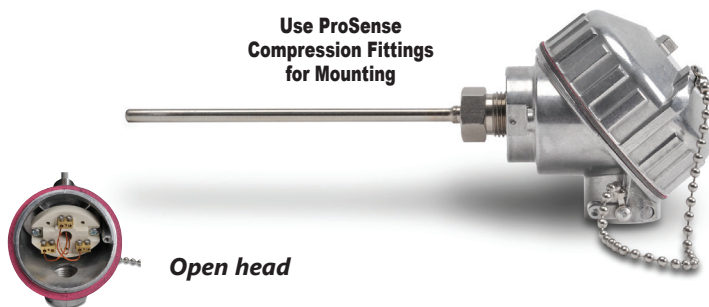

## Overview

- Probe
  - 100 ohm platinum RTD 3-wire element
  - Class A accuracy
  - 1/4" diameter, 316 SS sealed sheath to protect against harsh environments
  - RTD element encased in alumina powder insulation provides excellent vibration dampening and heat transfer
  - 6", 12" or 18" probe length
- Connection Head
  - Cast aluminum NEMA 4X, IP66 screw cover head with gasket
  - One turn cover removal & installation eliminates cross threading and saves time
  - 3/4" NPT conduit opening with internal stop to prevent overtightening and installation damage
  - Gripping ribs on cover edge
  - Stainless steel cover chain
- Wiring
  - Ceramic terminal base
  - Brass terminals with stainless steel screws eliminate the need to wrap connections around screws
  - Elevated terminal block for easy wire termination
- Made in the USA

RTD Probes with Connection Head								
Part Number	Pcs/Pkg	Wt (lb)	Price	RTD Type	Probe Diameter (O.D.)	Probe Length	Temperature Sensing Range	Mounting
<a href="#">RTD1-C06-01</a>	1	1.3	\$94.00	PT 100, 3-wire	1/4"	6"	-50 to 300°C (-58 to 572°F)	Integral 1/2" x 1/2" NPT Hex Nipple, 316 SS
<a href="#">RTD1-C12-01</a>			\$97.00			12"		
<a href="#">RTD1-C18-01</a>			\$100.00			18"		
<a href="#">RTD1-C06-02</a>			\$87.00			6"		ProSense compression fitting (see accessories - purchased separately)
<a href="#">RTD1-C12-02</a>			\$89.00			12"		
<a href="#">RTD1-C18-02</a>			\$93.00			18"		

Technical Specifications	
<b>Sensing Element</b>	Single 100Ω platinum (Pt 100), 3-wire; TCR = 0.00385 Ω/Ω/°C
<b>Initial Accuracy</b>	Class A ±[0.15 + 0.002  t ] °C
<b>Probe</b>	ø1/4", 316 stainless steel sheath, single RTD is embedded in alumina powder
<b>Minimum Installation Depth</b>	3" (76 mm)
<b>Connection Head</b>	Die-cast aluminum, screw cover with stainless steel chain, compressed graphite gasket, NEMA 4X, IP66, 3/4" NPT conduit opening, max temp. 400°F (204°C)
<b>Response Time</b>	7 seconds, 63% of a 25 to 77°C step change (ASTM E1137)
<b>Wiring</b>	Ceramic terminal base with brass terminals and stainless steel screws (recommended tightening torque 3-4 lb-in)



Note: Check the chemical compatibility of the sensor's wetted parts with the medium to be measured.

# prosense® RTD Probes with Connection Head

## Dimensions

inches [mm]

### RTD1-CXX-01

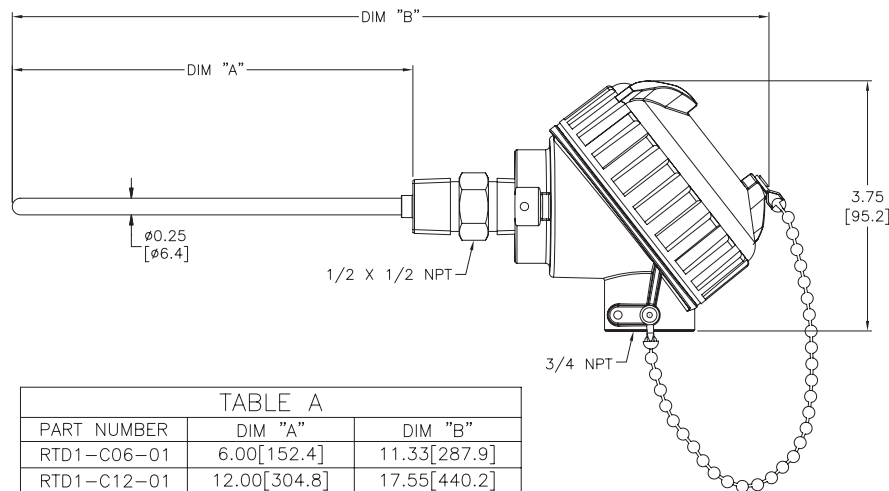
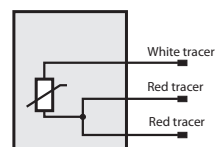
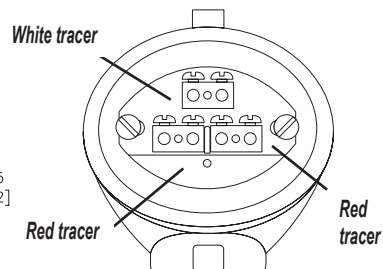

TABLE A		
PART NUMBER	DIM "A"	DIM "B"
RTD1-C06-01	6.00[152.4]	11.33[287.9]
RTD1-C12-01	12.00[304.8]	17.55[440.2]
RTD1-C18-01	18.00[457.2]	23.33[592.6]

## Wiring Information



- Ignore polarity marks on terminal base
- Recommended screw terminal tightening torque 3-4 lb-in

### RTD1-CXX-02

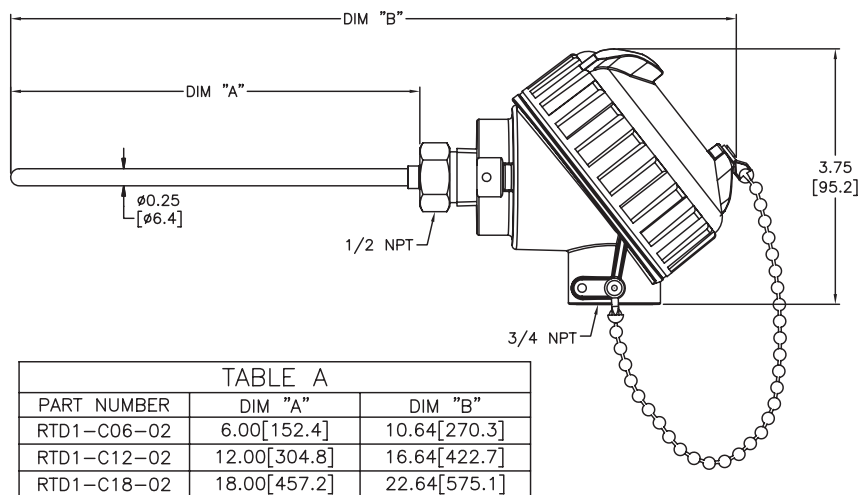

TABLE A		
PART NUMBER	DIM "A"	DIM "B"
RTD1-C06-02	6.00[152.4]	10.64[270.3]
RTD1-C12-02	12.00[304.8]	16.64[422.7]
RTD1-C18-02	18.00[457.2]	22.64[575.1]

## Accessories

Part No.	Description	Pcs/Pkg	Price
<b>BCF14-125N</b>	Compression fitting, brass, for 1/4 inch diameter temperature probes, 1/8 inch NPT male thread	1	\$3.25
<b>BCF14-25N</b>	Compression fitting, brass, for 1/4 inch diameter temperature probes, 1/4 inch NPT male thread	1	\$4.25
<b>BCF14-50N</b>	Compression fitting, brass, for 1/4 inch diameter temperature probes, 1/2 inch NPT male thread	1	\$6.50
<b>CF14-125N</b>	Compression fitting, 316 stainless steel, for 1/4 inch diameter temperature probes, 1/8 inch NPT male thread	1	\$8.00
<b>CF14-25N</b>	Compression fitting, 316 stainless steel, for 1/4 inch diameter temperature probes, 1/4 inch NPT male thread	1	\$9.25
<b>CF14-50N</b>	Compression fitting, 316 stainless steel, for 1/4 inch diameter temperature probes, 1/2 inch NPT male thread	1	\$14.00
<b>CFTF-14</b>	Teflon ferrule for brass or stainless steel compression fittings and 1/4 diameter temperature probes	5	\$7.75

Note: RTD extension lead wire available at [www.automationdirect.com](http://www.automationdirect.com)  
See end of section for full listing of accessories and dimension information.

# pro<sup>sense</sup>® Compression Mounting Fittings for Temperature Probes

Compression Mounting Fittings for Temperature Probes				
Part Number	Description	Pcs/Pkg	Wt(lb)	Price
<a href="#"><b>BCF18-125N</b></a>	Compression fitting, brass, for 1/8 inch diameter temperature probes, 1/8 inch NPT male thread	1	0.5	\$3.25
<a href="#"><b>BCF14-125N</b></a>	Compression fitting, brass, for 1/4 inch diameter temperature probes, 1/8 inch NPT male thread	1	0.5	\$3.25
<a href="#"><b>BCF18-25N</b></a>	Compression fitting, brass, for 1/8 inch diameter temperature probes, 1/4 inch NPT male thread	1	0.5	\$4.25
<a href="#"><b>BCF14-25N</b></a>	Compression fitting, brass, for 1/4 inch diameter temperature probes, 1/4 inch NPT male thread	1	0.5	\$4.25
<a href="#"><b>BCF18-50N</b></a>	Compression fitting, brass, for 1/8 inch diameter temperature probes, 1/2 inch NPT male thread	1	0.5	\$6.00
<a href="#"><b>BCF14-50N</b></a>	Compression fitting, brass, for 1/4 inch diameter temperature probes, 1/2 inch NPT male thread	1	0.5	\$6.50
<a href="#"><b>CF18-125N</b></a>	Compression fitting, 316 stainless steel, for 1/8 inch diameter temperature probes, 1/8 inch NPT male thread	1	0.5	\$8.00
<a href="#"><b>CF14-125N</b></a>	Compression fitting, 316 stainless steel, for 1/4 inch diameter temperature probes, 1/8 inch NPT male thread	1	0.5	\$8.00
<a href="#"><b>CF18-25N</b></a>	Compression fitting, 316 stainless steel, for 1/8 inch diameter temperature probes, 1/4 inch NPT male thread	1	0.5	\$9.25
<a href="#"><b>CF14-25N</b></a>	Compression fitting, 316 stainless steel, for 1/4 inch diameter temperature probes, 1/4 inch NPT male thread	1	0.5	\$9.25
<a href="#"><b>CF18-50N</b></a>	Compression fitting, 316 stainless steel, for 1/8 inch diameter temperature probes, 1/2 inch NPT male thread	1	0.5	\$13.50
<a href="#"><b>CF14-50N</b></a>	Compression fitting, 316 stainless steel, for 1/4 inch diameter temperature probes, 1/2 inch NPT male thread	1	0.5	\$14.00
<a href="#"><b>CFTF-18**</b></a>	Teflon™ ferrule for brass or stainless steel compression fittings and 1/8 diameter temperature probes	5	0.5	\$7.25
<a href="#"><b>CFTF-14**</b></a>	Teflon ferrule for brass or stainless steel compression fittings and 1/4 diameter temperature probes	5	0.5	\$7.75
<a href="#"><b>CF06-25N</b></a>	1/4 NPT stainless steel compression fitting for 0.24 inch (6 mm) diameter RTD probe with M12 connector.	1	0.18	\$28.50
<a href="#"><b>CF10-50N</b></a>	1/2 NPT stainless steel compression fitting for 10 mm (0.4 inch) diameter RTD probe with M12 connector.	1	0.20	\$30.00
<a href="#"><b>CF18-BC</b></a>	Bayonet compression fitting, for 1/8" diameter probe sheath sensors	1	0.1	\$10.00
<a href="#"><b>BB125N-50N</b></a>	Reducing bushing, brass, 1/2 MNPT x 1/8 FNPT, hex head	1	0.1	\$5.75

[\*\*BCF18-125N\*\*](#)



[\*\*BCF18-25N\*\*](#)



[\*\*BCF18-50N\*\*](#)



[\*\*BB125N-50N\*\*](#)



Note: Check the chemical compatibility of the sensor's wetted parts with the medium to be measured.

\* Working pressure of compression fitting should not exceed 500 psi. However we recommend any pressure application use a thermowell

\*\* Teflon has a max working temperature range of -400 to 500°F (-240 to 260°C)

[\*\*CFTF-14\*\*](#)



[\*\*CFTF-18\*\*](#)



[\*\*CF14-125N\*\*](#)



[\*\*CF14-50N\*\*](#)

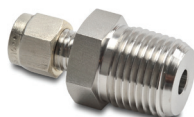

[\*\*CF14-25N\*\*](#)



[\*\*CF18-BC\*\*](#)



[\*\*CF06-25N\*\*](#)



[\*\*CF10-50N\*\*](#)



# pro<sup>sense</sup>® Compression Mounting Fittings for Temperature Probes

**BCF14-125N****BCF14-25N****BCF14-50N****CF18-25N****CF18-50N****CF18-125N**

## Dimensions

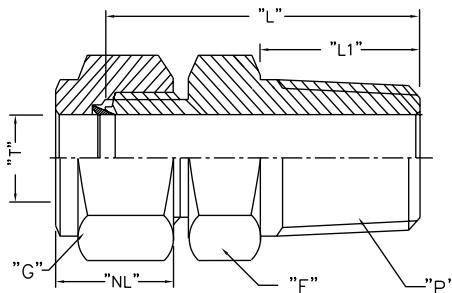

Note: All threaded connections should be hand tightened and then turned 1 to 2 full turns for proper sealing.

Actual torque required for a proper seal of NPT threads is influenced by tolerance, sealant, lubricant, etc.

ProSense Compression Fittings									
Part No.	Weight (lb)	Description	"T" Tube O.D.	"P" NPT(M)	"L" Body Length*	"L1" Thread Length**	"F" Body Hex**	"G" Nut Hex**	"NL" Nut Length**
<b>BCF18-125N/ CF18-125N</b>	0.5	1/8" OD x 1/8" NPT(M)	0.128/0.132	1/8" NPT(M)	0.909"	0.393"	0.5"	0.433"	0.492"
<b>BCF14-125N/ CF14-125N</b>	0.5	1/4" OD x 1/8" NPT(M)	0.253/0.257	1/8" NPT(M)	1.0"	0.393"	0.5"	0.559"	0.5"
<b>BCF18-25N/ CF18-25N</b>	0.5	1/8" OD x 1/4" NPT(M)	0.128/0.132	1/4" NPT(M)	1.114"	0.551"	0.551"	0.433"	0.492"
<b>BCF14-25N/ CF14-25N</b>	0.5	1/4" OD x 1/4" NPT(M)	0.253/0.257	1/4" NPT(M)	1.188"	0.551"	0.551"	0.559"	0.5"
<b>BCF18-50N/ CF18-50N</b>	0.5	1/8" OD x 1/2" NPT(M)	0.128/0.132	1/2" NPT(M)	1.377"	0.748"	0.866"	0.433"	0.492"
<b>BCF14-50N/ CF14-50N</b>	0.5	1/4" OD x 1/2" NPT(M)	0.253/0.257	1/2" NPT(M)	1.437"	0.748"	0.866"	0.559"	0.5"
<b>CF06-25N</b>	0.18	6 mm OD x 1/4" NPT(M)	0.236/0.240	1/4" NPT(M)	1.174"	0.59"	0.67"	0.55"	0.587"
<b>CF10-50N</b>	0.20	10 mm OD x 1/2" NPT(M)	0.394/0.399	1/2" NPT(M)	1.458"	0.55"	1.06"	0.75"	0.608"

Note: All dimensions are in inches

\* w 0.07

\*\* w 0.03

Note: Once the compression fitting has been fully tightened on the probe, the ferrule will be locked onto the probe and cannot be removed or reused.

\*Working pressure of compression fitting should not exceed 500 psi. However we recommend any pressure application use a thermowell



Scan the QR Code or click to view the CF06 & CF10 Compression Fitting Installation Instructions



# Bayonet Mounting Adapter for Temperature Sensors

Bayonet Mounting Adapter for Temperature Sensors					
Part Number	Description	Material	Pcs/Pkg	Wt(lb)	Price
<a href="#"><u>BA-078</u></a>	Bayonet adapter, 7/8 inch long, 7/16 inch outside diameter, 9/32 inch inside diameter, 1/8 inch MNPT	Stainless Steel (304)	1	0.5	\$1.75
<a href="#"><u>BA-100</u></a>	Bayonet adapter, 1 inch long, 7/16 inch outside diameter, 9/32 inch inside diameter, 1/8 inch MNPT		1	0.5	\$1.75
<a href="#"><u>BA-114</u></a>	Bayonet adapter, 1-1/4 inch long, 7/16 inch outside diameter, 9/32 inch inside diameter, 1/8 inch MNPT		1	0.5	\$2.25
<a href="#"><u>BA-112</u></a>	Bayonet adapter, 1-1/2 inch long, 7/16 inch outside diameter, 9/32 inch inside diameter, 1/8 inch MNPT		1	0.5	\$2.25
<a href="#"><u>BA-200</u></a>	Bayonet adapter, 2 inch long, 7/16 inch outside diameter, 9/32 inch inside diameter, 1/8 inch MNPT		1	0.5	\$2.50
<a href="#"><u>BA-212</u></a>	Bayonet adapter, 2-1/2 inch long, 7/16 inch outside diameter, 9/32 inch inside diameter, 1/8 inch MNPT		1	0.5	\$2.75
<a href="#"><u>BA-300</u></a>	Bayonet adapter, 3 inch long, 7/16 inch outside diameter, 9/32 inch inside diameter, 1/8 inch MNPT		1	0.5	\$3.00
<a href="#"><u>BA-312</u></a>	Bayonet adapter, 3-1/2 inch long, 7/16 inch outside diameter, 9/32 inch inside diameter, 1/8 inch MNPT		1	0.5	\$3.50
<a href="#"><u>CF18-BC</u></a>	Adjustable bayonet compression fitting, for 1/8" diameter probe sheath sensors		Brass	1	0.1
<a href="#"><u>BB125N-50N</u></a>	Reducing bushing, 1/2 MNPT x 1/8 FNPT, hex head	1		0.1	\$5.75

[BA-078](#)



[BA-100](#)



[BA-114](#)



*Note: Check the chemical compatibility of the sensor's wetted parts with the medium to be measured.*

[CF18-BC](#)



[BA-300](#)



[BA-112](#)



[BB125N-50N](#)



[BA-312](#)



[BA-200](#)



[BA-212](#)



# pro<sup>sense</sup>® Pipe Clamp Adapters

**PCA-300**

## Overview

- For use with ProSense adjustable immersion thermocouple and RTD sensors
- Available in adjustable diameters from 11/16 to 7 inches
- Provides an easy means of sensing temperature on the outside of a pipe

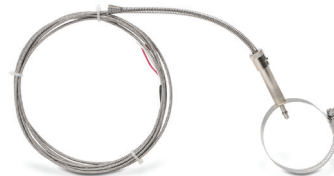

Shown with optional adjustable immersion sensor

## Pipe Clamp Adapters for ProSense Adjustable Immersion Sensors

Part Number	Description	Pcs/ Pkg	Wt(lb)	Price
<b>PCA-125</b>	ProSense pipe clamp adapter, 11/16 to 1-1/4 inch adjustable diameter, 2-inch attached bayonet adapter with 7/16 inch outside diameter and 9/32 inch inside diameter. Use with ProSense adjustable immersion sensors.	1	0.1	\$17.50
<b>PCA-200</b>	ProSense pipe clamp adapter with 1-1/16 to 2 inch adjustable diameter, 2-inch attached bayonet adapter with 7/16 inch outside diameter and 9/32 inch inside diameter. Use with ProSense adjustable immersion sensors.	1	0.1	\$18.00
<b>PCA-300</b>	ProSense pipe clamp adapter with 2-1/16 to 3 inch adjustable diameter, 2-inch attached bayonet adapter with 7/16 inch outside diameter and 9/32 inch inside diameter. Use with ProSense adjustable immersion sensors.	1	0.1	\$20.00
<b>PCA-425</b>	ProSense pipe clamp adapter with 3-5/16 to 4-1/4 inch adjustable diameter, 2-inch attached bayonet adapter with 7/16 inch outside diameter and 9/32 inch inside diameter. Use with ProSense adjustable immersion sensors.	1	0.1	\$22.50
<b>PCA-500</b>	ProSense pipe clamp adapter with 4-1/8 to 7 inch adjustable diameter, 2-inch attached bayonet adapter with 7/16 inch outside diameter and 9/32 inch inside diameter. Use with ProSense adjustable immersion sensors.	1	0.1	\$21.00

## Dimensions

inches [mm]

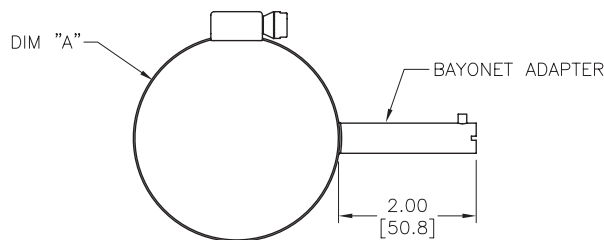

TABLE A

PART NUMBER	DIM "A"	FITS PIPE SIZES
PCA-125	ø0.68–1.25 [ø17.2–31.7]	1/2 TO 3/4 NPS
PCA-200	ø1.06–2.00 [ø26.9–50.8]	1 TO 1-1/2 NPS
PCA-300	ø2.06–3.00 [ø52.3–76.2]	2 TO 2-1/2 NPS
PCA-425	ø3.31–4.25 [ø84.1–108.0]	3 TO 3-1/2 NPS
PCA-500	ø4.12–7.00 [ø104.6–177.8]	4 TO 6 NPS

# proSense® Thermocouple, RTD, and Thermistor Connectors

## Overview

- Glass-filled high quality thermoplastic body with original thermocouple material pins and spring-loaded inserts
- Polarized pins
- Molded barriers prevent short circuit
- Captive central cover screw for easy assembly
- Easy wire connection pressure plate
- construction
- Stainless steel screws with combination head (Slotted and Phillips)
- 3-pin standard connectors have a third pin for ground or continuous shield, or for 3-wire RTDs

Thermocouple, RTD, and Thermistor Connectors												
Part Number	Pcs/ Pkg	Wt(lb)	Price	Sensor Type	Connector Type	Temperature Rating	Body Color	Wire Size	Wire Cable Clamp Bracket			
<a href="#">THMJ-SP</a>	1	0.5	\$4.00	J	Standard round pin plug	Max continuous 400°F (200°C)	Black	32 AWG (0.2 mm) to 14 AWG maximum (2.0 mm)	WCB-S			
<a href="#">THMJ-SJ</a>	1	0.5	\$5.25		Standard round pin jack					-		
<a href="#">THMJ-SPJ</a>	1	0.5	\$10.00		Standard round direct mount jack							
<a href="#">THMJ-MP</a>	1	0.5	\$3.75		Miniature flat pin plug				40 AWG (0.08 mm) to 20 AWG maximum (0.8 mm)		WCB-M	
<a href="#">THMJ-MJ</a>	1	0.5	\$4.25		Miniature flat pin jack							
<a href="#">THMJ-MPJ</a>	1	0.5	\$6.75		Miniature round direct mount jack							
<a href="#">THMK-SP</a>	1	0.5	\$4.50	K	Standard round pin plug		Max continuous 662°F (350°C)	Yellow	32 AWG (0.2 mm) to 14 AWG maximum (2.0 mm)	WCB-S		
<a href="#">THMK-SJ</a>	1	0.5	\$5.50		Standard round pin jack						-	
<a href="#">THMK-SPJ</a>	1	0.5	\$10.00		Standard round direct mount jack							
<a href="#">THMK-MP</a>	1	0.5	\$4.00		Miniature flat pin plug					40 AWG (0.08 mm) to 20 AWG maximum (0.8 mm)		WCB-M
<a href="#">THMK-MJ</a>	1	0.5	\$4.25		Miniature flat pin jack							
<a href="#">THMK-MPJ</a>	1	0.5	\$7.50		Miniature round direct mount jack							
<a href="#">THMK-HSP</a>	1	0.5	\$13.00	Standard hi-temp round pin plug	Max continuous 400°F (200°C)	Brown		32 AWG (0.2 mm) to 14 AWG maximum (2.0 mm)	WCB-S			
<a href="#">THMK-HSJ</a>	1	0.5	\$15.00							Standard hi-temp round pin jack		
<a href="#">THMT-SP</a>	1	0.5	\$4.25	T		Standard round pin plug		Max continuous 400°F (200°C)	Blue	40 AWG (0.08 mm) to 20 AWG maximum (0.8 mm)	WCB-M	
<a href="#">THMT-SJ</a>	1	0.5	\$5.75			Standard round pin jack						-
<a href="#">THMT-SPJ</a>	1	0.5	\$9.50			Standard round direct mount jack						
<a href="#">THMT-MP</a>	1	0.5	\$4.00			Miniature flat pin plug					40 AWG (0.08 mm) to 20 AWG maximum (0.8 mm)	
<a href="#">THMT-MJ</a>	1	0.5	\$4.50			Miniature flat pin jack						
<a href="#">THMT-MPJ</a>	1	0.5	\$8.00			Miniature round direct mount jack						
<a href="#">RTD-SP</a>	1	0.5	\$9.00	RTD		Standard round pin plug	Max continuous 400°F (200°C)		White	32 AWG (0.2 mm) to 14 AWG maximum (2.0 mm)	WCB-S	
<a href="#">RTD-SJ</a>	1	0.5	\$11.50			Standard round pin jack						
<a href="#">NTC-SJ</a>	1	0.5	\$6.75	Thermistor		Standard round pin jack						

[THMT-SP](#)



[THMT-SJ](#)



[THMK-SP](#)



[THMK-SJ](#)



[THMK-MP](#)



[THMJ-MJ](#)



[THMT-SPJ](#)



[THMT-MPJ](#)



[RTD-SP](#)

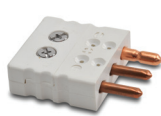

[RTD-SJ](#)



[THMK-HSP](#)



[THMK-HSJ](#)



[NTC-SJ](#)



# proSense® Thermocouple, RTD, and Thermistor Connectors

## Dimensions

inches [mm]

**THMJ, K, T, & H-SP**

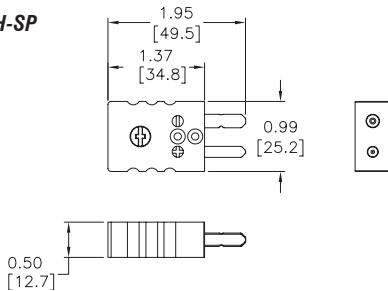

**THMJ, K, T, & H-SJ**

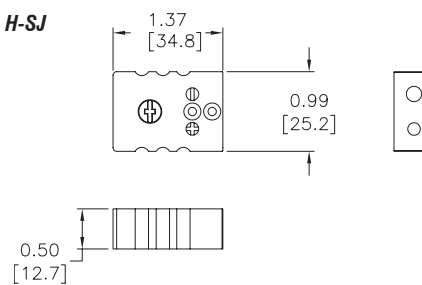

**THMJ, K, & T-MP**

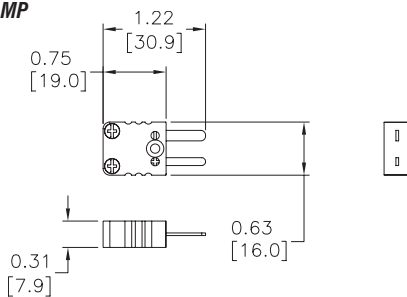

**THMJ, K, & T-MJ**

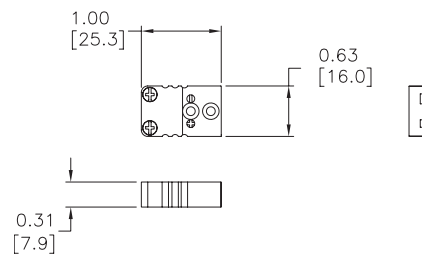

**THMJ, K, & T-SPJ**

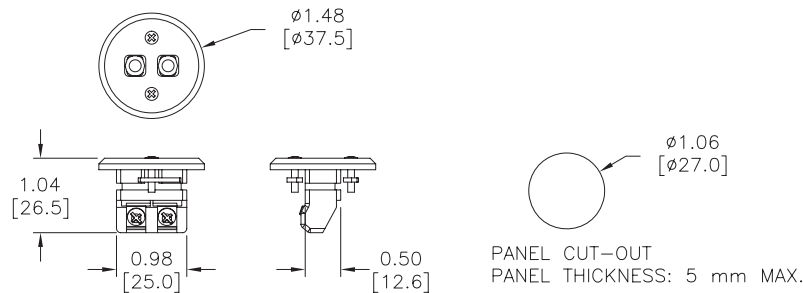

**THMJ, K, & T-MPJ**

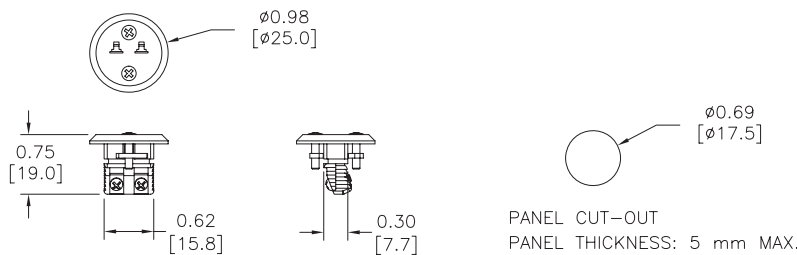

**RTD-SP**

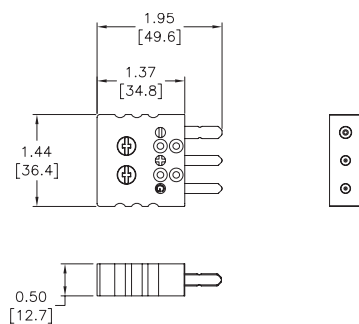

**RTD-SJ**

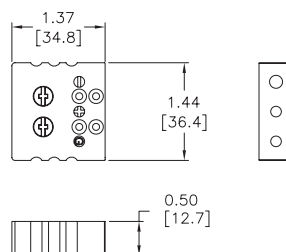

**NTC-SJ**

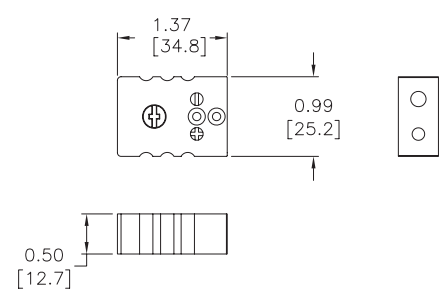



# pro<sup>ense</sup>® Thermocouple and RTD Connectors

**WCB-S**



**WCB-M**



**WCB-S Application**



**WCB-M Application**



Thermocouple and RTD Connectors Accessories				
Part Number	Pcs/ Pkg	Wt(lb)	Price	Description
WCB-S	4	0.5	\$7.00	Wire / cable clamp bracket for use with standard thermocouple and RTD connectors.
WCB-M	4	0.5	\$6.75	Wire / cable clamp bracket for use with miniature thermocouple connectors.

## Dimensions

inches [mm]

**WCB-S**

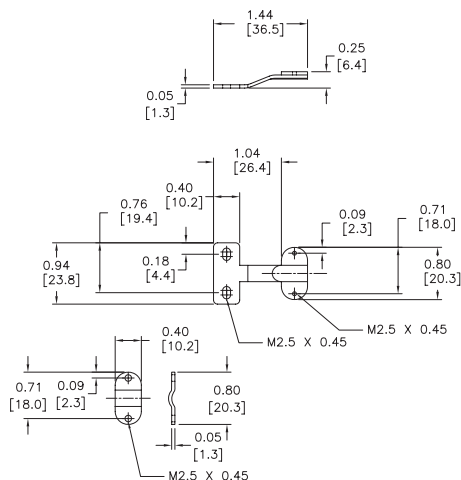

**WCB-M**

