

# RHINO PSM24-REM360S Redundancy Module

Using two PSM24 power supplies and a redundancy module, you can configure a redundant power system, featuring active current sharing, without any additional components. Even if one power supply fails or becomes disconnected, the second unit will supply full current to the load. The module has an alarm contact for monitoring of operations. The inputs are hot-swappable and can be loaded up to 15A each.



Redundancy Module						
Part Number	Price	Drawing Link	Input	Max Power per Input	Output Voltage Adjust	Output Power Max
<b>PSM24-REM360S</b> (includes terminal plugs)	\$199.00	<a href="#">PDF</a>	2 x 24VDC 2 x Control Input	2 x 360W	24VDC [24 - 27 VDC]	360W

General Specifications	
<b>Operating Temperature</b>	-25 to 70°C max [-13 to 158°F], derating above 40°C [104°F]
<b>Electromagnetic Compatibility</b>	In correspondence to connected units [no internal switching device]
<b>Redundancy OK Signal</b>	Trigger threshold at 18 to 22VDC
<b>Remote Link Wire 0.5m</b>	Two cables included with PSM24-REM360S module
<b>Remote ON/OFF</b>	By external contact: ON = J5.3 + J5.4 not shorted OFF = J5.3 + J5.4 shorted
<b>Alarm Contact Rating</b>	30 VDC/1.0 A max

**Redundancy Module Function Diagram**

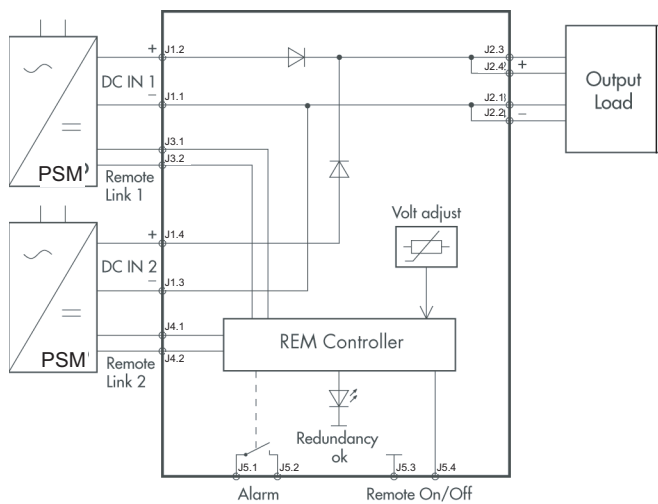

**Redundancy Module Connector Positions**

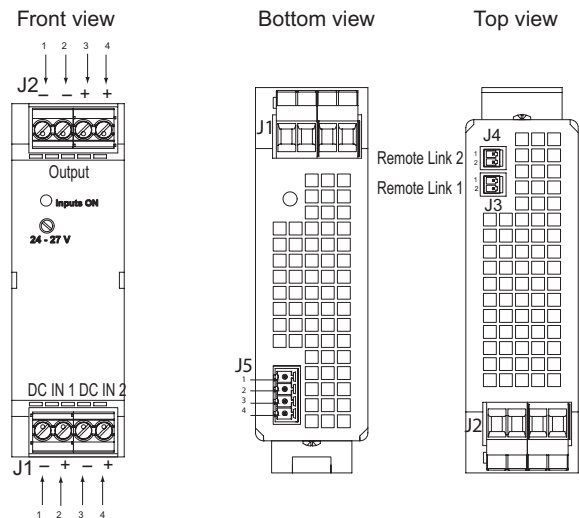

*Note: this redundancy module only works with the PSM series. Other series of power supplies are not compatible.*

Wiring Connections					
Pin	J1	J2	J3 Voltage control 1 for Input 1	J4 Voltage control 2 for Input 2	J5
1	Input 1 -Vin	GND [-]	S+	S+	DC-OK Signal
2	Input 1 +Vin	GND [-]	S-	S-	DC-OK Relay contact
3	Input 2 -Vin	Vout [+]	—	—	Remote ON/OFF
4	Input 2 +Vin	Vout [+]	—	—	Remote ON/OFF

# RHINO PSM Power Supplies - Accessories

A variety of accessories is available to complement the RHINO PSM power supplies. Choose panel mounting brackets and replacement plug kits from the table below, based on the size of the power supply. There is also a temperature sensor for the battery control module and replacement link cable for the redundancy and battery control modules.

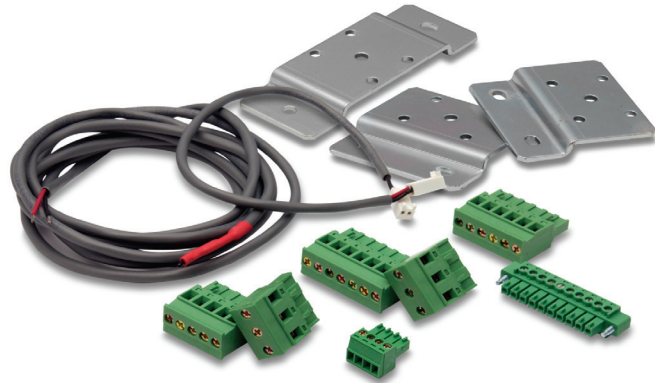

Accessories			
Part Number	Price	Drawing Link	Description
<a href="#">PSM-PANEL1</a>	\$38.00	<a href="#">PDF</a>	Panel mounting bracket. 1 bracket type A includes M4-screw [DIN 74-4fA] for 78W, 90W, 156W, 180W PSM power supplies
<a href="#">PSM-PANEL2</a>	\$33.00	<a href="#">PDF</a>	Panel mounting bracket. 2 brackets type A include M4-screws [DIN 74-4fA] for 360W, 600W PSM power supplies
<a href="#">PSM-PK1</a>	\$8.50	N/A	Replacement plug kit for PSM series with 78W and 90W outputs
<a href="#">PSM-PK2</a>	\$12.50	N/A	Replacement plug kit for PSM series with 156W, 180W and 360W outputs
<a href="#">PSM-TS</a>	\$33.50	N/A	Temperature sensor for <a href="#">PSM24-BCM360S</a> battery control module
<a href="#">PSM-JC01</a>	\$9.00	N/A	Replacement link cable for PSM series redundancy module <a href="#">PSM24-REM360S</a> and battery control module <a href="#">PSM24-BCM360S</a>

## Mounting

PSM power supplies are designed for mounting on a DIN rail. Please allow minimum free space of 80 mm (3.15") above and below, and 50 mm (1.97") on each side of the power supply for air convection. To attach unit onto the DIN rail, hook the top part of clip on DIN rail, then push down and inward until you hear the clipping sound. To remove, pull the latch of the clip using an insulated flathead screwdriver.

For wall or chassis mounting, use mounting brackets [PSM-PANEL1](#) (for 78W to 180W PSM style power supplies) or [PSM-PANEL2](#) (for 360W and 600W PSM power supplies). Remove the DIN clips and replace with the brackets. Use the countersink screws included with the wall mount kit to attach the brackets to the power supply.

To attach the power supply to the DIN rail

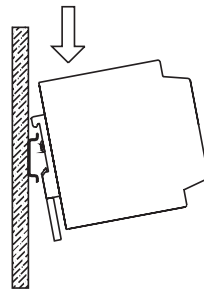

Fig. 2.1

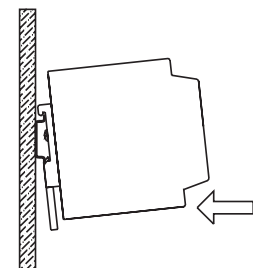

Fig. 2.2

To remove the power supply from DIN rail

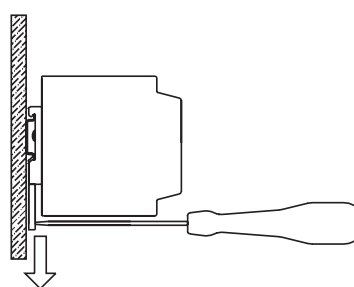

Fig. 2.3

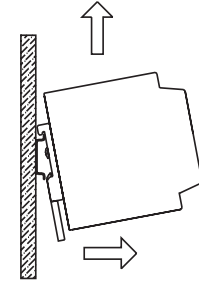

Fig. 2.4