

# RHINO PSM24-BFM600S Buffer Module



The buffer module will maintain the output voltage of a 24 VDC power supply after brownouts or voltage dips for up to 200ms at 25 amps. It is a cost effective alternative to a battery-based backup system. The operation modes are indicated by an LED on the front panel.

Storing the energy in a capacitor bank, this backup solution is completely maintenance free. Its storage capacity does not deteriorate over the lifetime of the unit.

Buffer Module						
Part Number	Price	Drawing Link	Input	Operating Voltage Range	Buffer Time	Output Power Max
PSM24-BFM600S (includes terminal plugs)	\$231.00	<a href="#">PDF</a>	24VDC	22 to 28VDC	200 msec typical @ 25A max load 4.0 sec maximum @ 1.2A load	25.0 A [600W]

General Specifications	
Operating Temperature	-25 to 70°C max [-13 to 158°F], derating above 40°C [104°F]
Electromagnetic Compatibility	In correspondence to connected units [no internal switching device]
Buffer Voltage	Adjustable, >1 V below input voltage, min. 22 VDC
Charging	0.6 A max/30s max
Status Signals	Buffer Active, Buffer Ready [optocoupler output], dual-color LED for status indication
Inhibit Input	Optocoupler input: supply between 5VDC and 28VDC to inhibit
Signal Output Ratings	10mA

Buffer Module Function Diagram

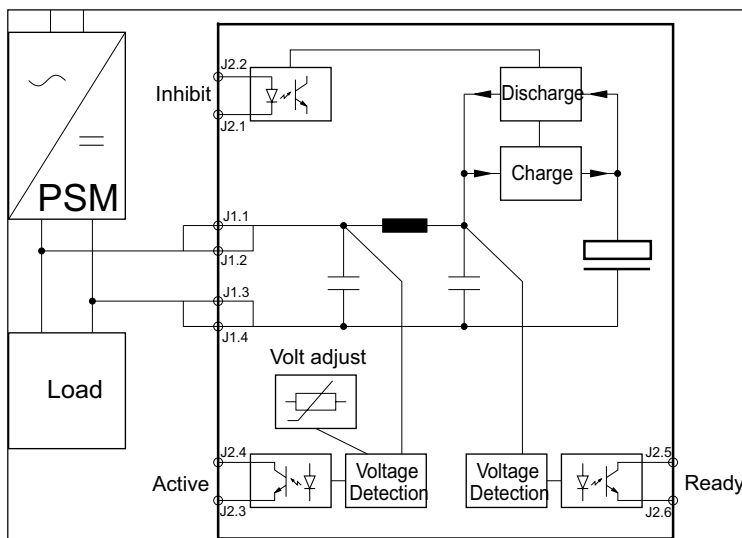

Buffer Module Connector Positions

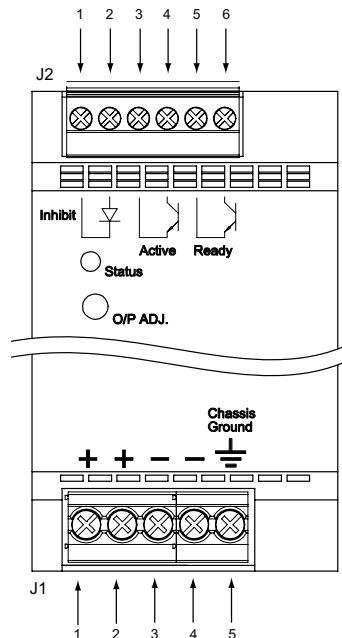

Wiring Connections		
Pin	J1	J2
1	+ Vin	Inhibit GND
2	+ Vin	Inhibit +
3	- Vin	Active GND
4	- Vin	Active Signal
5	FG	Ready GND
6	—	Ready Signal

# RHINO PSM Power Supplies - Accessories

A variety of accessories is available to complement the RHINO PSM power supplies. Choose panel mounting brackets and replacement plug kits from the table below, based on the size of the power supply. There is also a temperature sensor for the battery control module and replacement link cable for the redundancy and battery control modules.

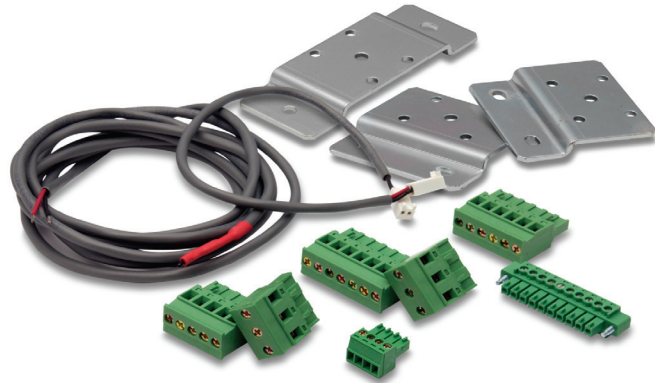

Accessories			
Part Number	Price	Drawing Link	Description
<a href="#">PSM-PANEL1</a>	\$38.00	<a href="#">PDF</a>	Panel mounting bracket. 1 bracket type A includes M4-screw [DIN 74-4fA] for 78W, 90W, 156W, 180W PSM power supplies
<a href="#">PSM-PANEL2</a>	\$33.00	<a href="#">PDF</a>	Panel mounting bracket. 2 brackets type A include M4-screws [DIN 74-4fA] for 360W, 600W PSM power supplies
<a href="#">PSM-PK1</a>	\$8.50	N/A	Replacement plug kit for PSM series with 78W and 90W outputs
<a href="#">PSM-PK2</a>	\$12.50	N/A	Replacement plug kit for PSM series with 156W, 180W and 360W outputs
<a href="#">PSM-TS</a>	\$33.50	N/A	Temperature sensor for <a href="#">PSM24-BCM360S</a> battery control module
<a href="#">PSM-JC01</a>	\$9.00	N/A	Replacement link cable for PSM series redundancy module <a href="#">PSM24-REM360S</a> and battery control module <a href="#">PSM24-BCM360S</a>

## Mounting

PSM power supplies are designed for mounting on a DIN rail. Please allow minimum free space of 80 mm (3.15") above and below, and 50 mm (1.97") on each side of the power supply for air convection. To attach unit onto the DIN rail, hook the top part of clip on DIN rail, then push down and inward until you hear the clipping sound. To remove, pull the latch of the clip using an insulated flathead screwdriver.

For wall or chassis mounting, use mounting brackets [PSM-PANEL1](#) (for 78W to 180W PSM style power supplies) or [PSM-PANEL2](#) (for 360W and 600W PSM power supplies). Remove the DIN clips and replace with the brackets. Use the countersink screws included with the wall mount kit to attach the brackets to the power supply.

To attach the power supply to the DIN rail

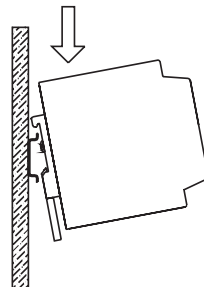

Fig. 2.1

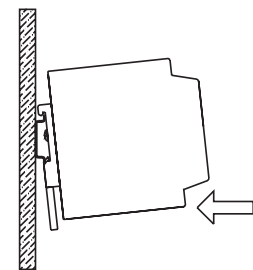

Fig. 2.2

To remove the power supply from DIN rail

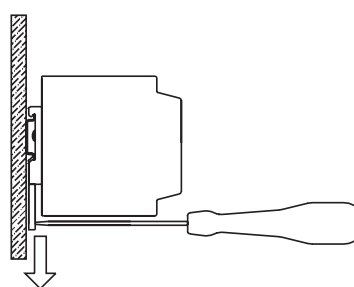

Fig. 2.3

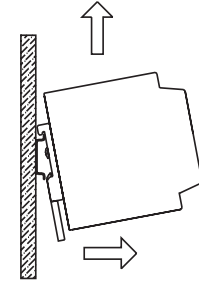

Fig. 2.4