

RHINO PSM24-BCM360S Battery Control Module

The battery control module, when combined with a PSM24 power supply, makes a perfect DC-UPS system by providing the means to charge and monitor an external lead acid battery. The power supply charges the connected battery and keeps it in a charged mode.

Consequently, the output voltage of the system is equivalent to the battery voltage. To avoid overcharging the battery, an external temperature sensor automatically adjusts the battery voltage to the required end of charge voltage. This configuration extends the battery life.



Battery Control Module						
Part Number	Price	Drawing Link	Input	Input Power Max	Output Voltage Nom	*Output Power Max
PSM24-BCM360SPSM24-BCM360S (includes terminal plugs)	\$196.00	PDF	24VDC power supply and 24VDC battery	360W	24VDC	360W

*reduce maximum output current by battery charging current.

General Specifications	
Operating Temperature	-25 to 70°C max [-13 to 158°F] 1.5%/K, derating above 40°C [104°F]
Electromagnetic Compatibility	In correspondence to connected units [no internal switching device]
Battery Protection	Over voltage, deep discharge, short-circuit and reverse connection [built-in fuse]
Status Signals	DC-OK input, DC-OK output, BAT OK [all relay contacts closed at status OK]
Rating per Relay Contact	30 VDC / 1.0 A max.
Remote Link Wire 0.5m	One cable included with PSM24-BCM360S module
Remote ON/OFF	By external contact: ON = J5.7 + J5.8 not shorted OFF = J5.7 + J5.8 shorted

Battery Control Module Function Diagram

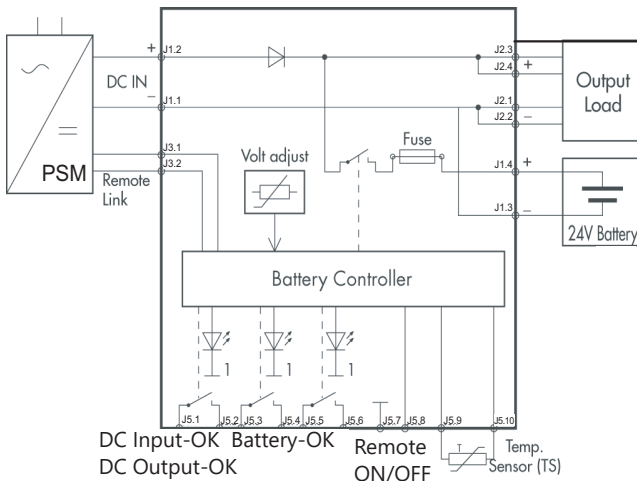

Battery Control Module Connector Positions

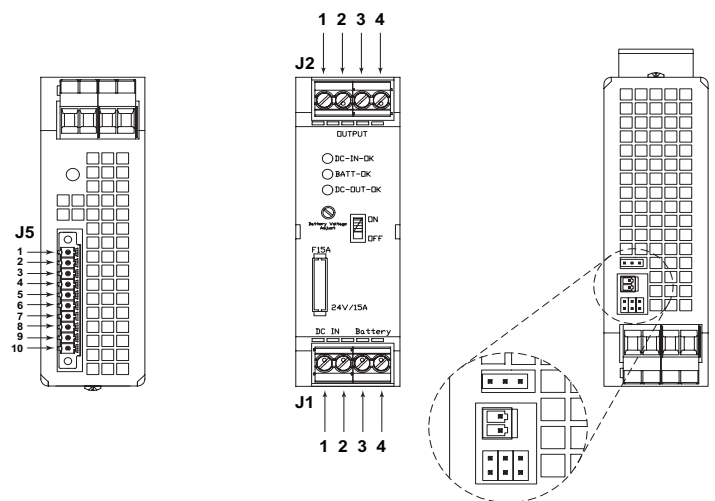

PIN	J1	J2	J3	J4	J5	J6
1	- Vin [DC In]	GND [-]	S+	15 sec test	DC-IN-OK Signal	PSM24-360S [factory setting]
2	+ Vin [DC In]	GND [-]	S-	Common	DC-IN-OK Relay contact	PSM24-180S
3	- Bat in	Vout [+]	—	10 min test	Bat-OK Signal	PSM24-090S
4	+ Bat in	Vout [+]	—	—	Bat-OK Relay Contact	—
5	—	—	—	—	DC-OUT-OK Signal	—
6	—	—	—	—	DC-OUT-OK Relay Contact	—
7	—	—	—	—	Remote ON/OFF	—
8	—	—	—	—	Remote ON/OFF	—
9	—	—	—	—	Temperature Sensing	—
10	—	—	—	—	Temperature Sensing	—

RHINO PSM Power Supplies - Accessories

A variety of accessories is available to complement the RHINO PSM power supplies. Choose panel mounting brackets and replacement plug kits from the table below, based on the size of the power supply. There is also a temperature sensor for the battery control module and replacement link cable for the redundancy and battery control modules.

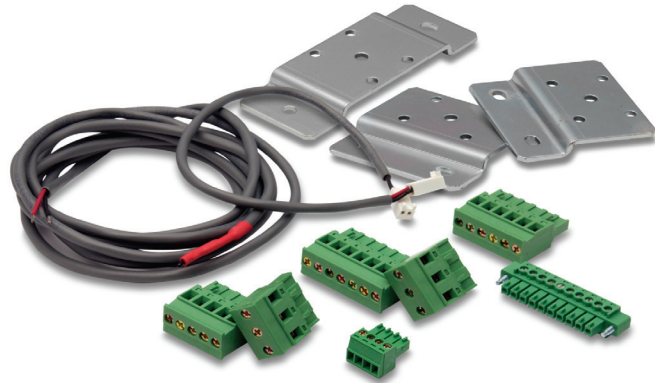

Accessories			
Part Number	Price	Drawing Link	Description
PSM-PANEL1	\$38.00	PDF	Panel mounting bracket. 1 bracket type A includes M4-screw [DIN 74-4fA] for 78W, 90W, 156W, 180W PSM power supplies
PSM-PANEL2	\$33.00	PDF	Panel mounting bracket. 2 brackets type A include M4-screws [DIN 74-4fA] for 360W, 600W PSM power supplies
PSM-PK1	\$8.50	N/A	Replacement plug kit for PSM series with 78W and 90W outputs
PSM-PK2	\$12.50	N/A	Replacement plug kit for PSM series with 156W, 180W and 360W outputs
PSM-TS	\$33.50	N/A	Temperature sensor for PSM24-BCM360S battery control module
PSM-JC01	\$9.00	N/A	Replacement link cable for PSM series redundancy module PSM24-REM360S and battery control module PSM24-BCM360S

Mounting

PSM power supplies are designed for mounting on a DIN rail. Please allow minimum free space of 80 mm (3.15") above and below, and 50 mm (1.97") on each side of the power supply for air convection. To attach unit onto the DIN rail, hook the top part of clip on DIN rail, then push down and inward until you hear the clipping sound. To remove, pull the latch of the clip using an insulated flathead screwdriver.

For wall or chassis mounting, use mounting brackets [PSM-PANEL1](#) (for 78W to 180W PSM style power supplies) or [PSM-PANEL2](#) (for 360W and 600W PSM power supplies). Remove the DIN clips and replace with the brackets. Use the countersink screws included with the wall mount kit to attach the brackets to the power supply.

To attach the power supply to the DIN rail

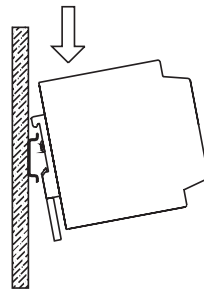

Fig. 2.1

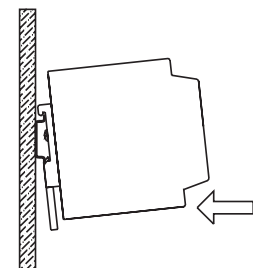

Fig. 2.2

To remove the power supply from DIN rail

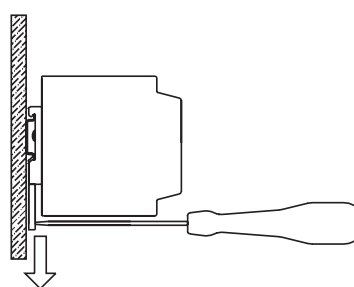

Fig. 2.3

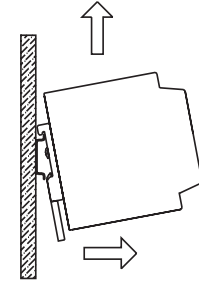

Fig. 2.4

RHINO Battery Control Modules Overview

A battery control module (BCM), in combination with an external sealed lead acid battery, can be added to a DC power supply to create a DC uninterruptible power supply (UPS) that will maintain power to a connected load upon loss of mains power.

The battery control module performs several key functions in the DC UPS system. Under normal conditions, it monitors the status of the DC input power, monitors and controls charging of the external lead acid battery, and provides status/alarm contacts to allow remote monitoring of the state of the UPS.

In the event that the DC power supply voltage drops out, the BCM monitors and supplies power to the load from the battery and monitors the battery during discharge.

Several battery control modules, with a range of features, are available for use with RHINO power supplies. Key differentiating features of the battery control modules are delineated in the following table.

Battery Control Module Selection Guide				
Part Number	<i>PSH-BCM360S</i>	<i>PSB24-BCM960S</i>	<i>PSL-24-BCM240</i>	<i>PSM24-BCM360S</i>
Price	\$242.00	\$66.00	\$34.50	\$196.00
Drawing Link	PDF	PDF	PDF	PDF
Highlights	Most versatile	Highest power Lowest cost/watt Conformal coating	Lowest cost	Legacy
Nominal Output Voltage	24/48 VDC	24 VDC	24 VDC	24 VDC
Amperage Rating	15A at 24 VDC, 7.5 A at 48 VDC	40A	10A	15A
Number of Power Inputs	Redundant inputs for two independent power supplies	One power supply	One power supply	One power supply
Battery Type	12V sealed lead acid	24V sealed lead acid	24V sealed lead acid	24V sealed lead acid
Protection Type	Over voltage, Over current, Deep discharge, Reverse polarity, Battery overcharge, Over temperature			
Battery Temperature Compensation	Yes	No	No	Yes
Compatibility	Universal	Universal	Universal	Requires RHINO PSM24 power supply

