

WSK Series Weld Slag Resistant Inductive Proximity Sensors

M18 (18mm)



- Low cost/high performance
- Weld slag resistant coating
- Inductive sensor
- Full metal housing
- Increased sensing range
- Gold-plated contacts
- Flush mounting
- Lifetime warranty



WSK Series M18 Inductive Proximity Selection Chart

Part Number	Price	Sensing Range	Mounting	Output State	Logic	Voltage	Connection	Wiring	Dimensions
WSK-AP-3H	\$43.50	8mm [0.31 in]	Flush	N.O.	PNP	10 - 30 VDC	4-pin M12 quick-disconnect	Diagram 1	Figure 1
WSK-A0-3E	Retired	6mm [0.24 in]			PNP/NPN	10 - 36 VDC	4-pin M12 with 0.3 m cable	Diagram 2	Figure 3

Wiring Diagrams

Diagram 1

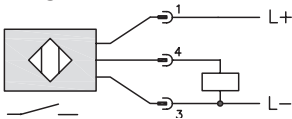
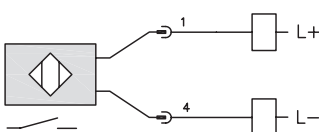

Diagram 2



Connectors

4-pin M12 PNP



4-pin M12 0.3m



Dimensions

mm [inches]

Figure 1

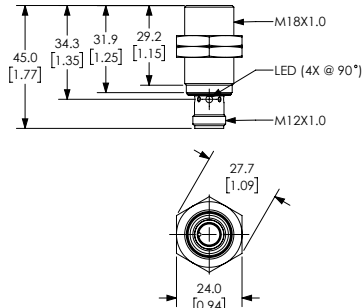

Figure 2

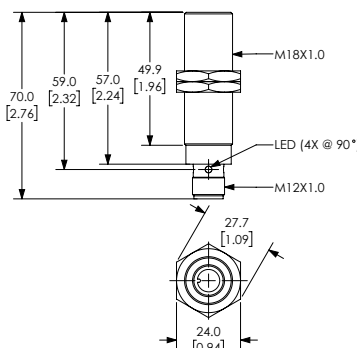
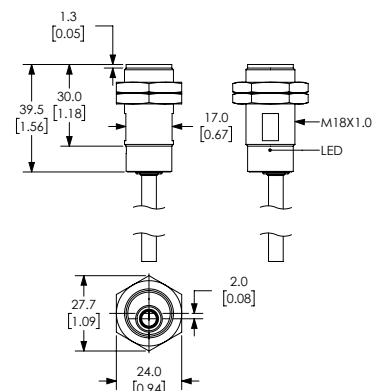

Figure 3



WSK Series Weld Slag Resistant Inductive Proximity Sensors

WSK Series M18 Inductive Proximity Specifications		
Model	<i>WSK-AP-3H</i>	<i>WSK-A0-3E</i>
Mounting Type	Flush	
Nominal Sensing Distance	8mm [0.31 in]	6mm [0.24 in]
Operating Distance	0 - 6.48 mm	0 - 4.0 mm
Material Correction Factors	See the Material Influence table	
Output Type	N.O.	
Operating Voltage	10 to 30 VDC	10 to 36 VDC
No-load Supply Current	< 10mA	NA
Operating (Load) Current	< 100mA	
Off-state Leakage Current	NA	< 0.6 mA
Voltage Drop	< 2.5 V	
Switching Frequency	2Hz	50Hz
Differential Travel (% of Nominal Distance)	3 - 15	1 - 20
Repeat Accuracy	NA	
Ripple	NA	
Time Delay Before Availability (tv)	NA	
Short Circuit Protection	Yes	Pulsed
Operating Temperature	-40 to 85°C [-40 to 185°F]	-25 to 70°C [-13 to 158°F]
Protection Degree (DIN 40050)	IP65 / IP66 / IP67 / IP68 / IP69K	IP67
LED Indicators	Illuminated when energized	
Housing Material	Stainless steel 316L / 1.4404 with anti-spatter ceramic (Polytetrafluoroethylene [PTFE]) coating	
Sensing Face Material	active face: stainless steel 316L 1.4404 anti-spatter	
Shock/Vibration	See Proximity Sensor Terminology	
Weight	0.046 kg	0.067 kg
Connection	4-pin M12 quick-disconnect	PUR cable / 0.3 m; 2 x 0.5 mm ² ; with M12 quick-disconnect
Agency Approvals	cULus E328811, CE	

To obtain the most current agency approval information, see the Agency Approval Checklist section on the specific part number's web page.