

Proximity Sensor Terminology

The following descriptions refer to the European standard EN 60947-5-2, of 2007.

The specifications given here are intended to be minimum performance values described by the standard.

Alignment

Proximity switches must not be mutually influenced. For this reason, a minimum distance between them (referred to as alignment) must be provided. Where not explicitly listed on product data sheet or installation instructions, follow these general guidelines.

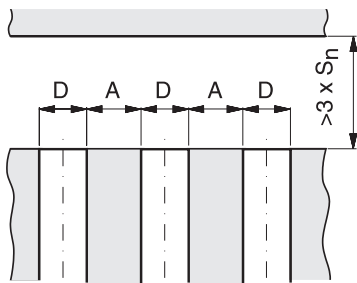

Size D	Flush A (mm)	Non-flush A (mm)
Ø3	0	--
M4	0	--
Ø4	0	--
M5	0	--
5X5	0	--
M8	2 / 3*	8
8X8	2 / 3*	--
M12	6 / 10*	12
M18	12 / 20*	30
M30	30	60

*Extended distance models

Break function (N.C., normally closed)

A break function causes load current to flow only when a target is not detected.

Protection degree

If not otherwise specified, proximity switches (when installed in accordance with manufacturer's instructions) have minimum IP65 protection against dust and water jets.

Differential travel (Hysteresis)

The differential travel is given as a percentage of the nominal sensing distance (S_n) and is the maximum difference between the switching distances. The differential is intentionally introduced to guarantee the stability of the output state in case the target is positioned near the switching points.

Electrical connections

Keep sensor cables and power cables separated to avoid electrical interference.

The power supply voltage must not exceed the specified limits U_b .

If a non-stabilized supply voltage is used for DC sensors, the maximum voltage peak under minimum power consumption conditions and minimum voltage peak under maximum power consumption must not exceed U_b limits.

If the power supply of the sensor is also used to switch inductive loads, a suppression device must be provided. A fuse to protect the power supply line is also recommended.

Installation notes

Select a sensor compatible with the operating environment: verify the compatibility between building materials, the presence of chemicals, temperature range, protection degree, vibrations, shocks, EMC, supply voltage available, load type, etc.

Select the sensor by referring to the size and type of material to be detected.

Check the minimum distances between sensor and damping materials or another sensor.

Check that the number of operations does not exceed the maximum switching frequency. If the phase of the output signal is important, check the turn on and turn off time.

Metallic chips or dust must not accumulate on the sensing face. The distance between the sensor and the object to detect must not exceed the assured operating distance S_a ; the best sensing range is $S_n/2$.

Check the effect of vibrations.

Install the sensor using the installation accessories and do not exceed the maximum tightening torque.

Indication/switch status

Proximity switches may incorporate one or more color indicators. The meaning of the colors vary by part. Please see part specifications for meaning.

Make function (N.O., normally open)

A make function causes load current to flow only when a target is detected.

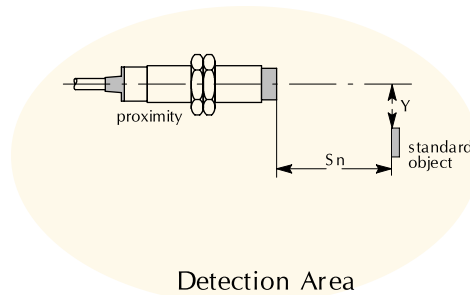

Proximity Sensor Terminology

Material influence

The nominal sensing distance (Sn) is defined using precisely defined measuring conditions (See Operating Distance). Other conditions may result in a reduction of the operating distance. The table below shows the influence different target materials have on the operating distances of the sensors.

Material Influence					
Sensor Series	Target Material Value				
	Steel	Copper	Aluminum	Brass	Stainless Steel
AC1-**-1*	1.00	0.28	0.21	0.32	0.63
AC1-**-3*	1.00	0.29	0.23	0.31	0.66
AE*-A*-1*	1.00	0.29	0.38	0.49	0.78
AE*-A*-2*	1.00	0.43	0.51	0.59	0.83
AE*-A*-3*	1.00	0.35	0.43	0.52	0.78
AE*-A*-4*	1.00	0.47	0.52	0.58	0.79
AE*-A*-5*	1.00	0.27	0.33	0.41	0.72
AE9-10-1*	1.00	0.25	0.28	0.40	0.68
AES-**-1*	1.00	0.15	0.10	0.15	0.55
AES-**-3*	1.00	0.15	0.15	0.21	0.56
AHS-**-1*	1.00	0.10	0.05	0.13	0.54
AHS-**-3*	1.00	0.05	0.05	0.10	0.50
AK1-A*-1*	1.00	0.40	0.48	0.72	0.86
AK1-A*-2*	1.00	0.45	0.53	0.56	0.77
AK1-A*-3*	1.00	0.40	0.45	0.50	0.75
AK1-A*-4*	1.00	0.45	0.53	0.56	0.77
AK9-**-1*	1.00	0.15	0.18	0.28	0.60
AM*-A*-1*	1.00	0.22	0.31	0.41	0.77
AM*-A*-2*	1.00	0.41	0.47	0.56	0.86
AM*-A*-3*	1.00	0.33	0.40	0.50	0.82
AM*-A*-4*	1.00	0.41	0.46	0.52	0.71
AM1-A0-1*	1.00	0.30	0.35	0.50	0.80
AM1-A0-2*	1.00	0.52	0.57	0.62	0.87
AM1-A0-3*	1.00	0.42	0.47	0.55	0.80
AM1-A0-4*	1.00	0.51	0.56	0.62	0.78
AM*/0-5H	1.00	0.25	0.30	0.40	0.70
AM9-**-1*	1.00	0.20	0.28	0.35	0.47
APS4-12*-E*-D	1.00	0.35	0.45	0.55	0.70
APS25-8*-E*-D	1.00	0.40	0.50	0.50	0.75
AT1-A*-1*	1.00	0.35	0.45	0.50	0.75
AT1-A*-2*	1.00	0.45	0.50	0.55	0.80
AT1-A*-3*	1.00	0.35	0.45	0.50	0.70
AT1-A*-4*	1.00	0.45	0.50	0.55	0.75
AT9-**-1*	1.00	0.17	0.20	0.30	0.65
CR5-A*-**	1.00	0.60	0.60	0.70	0.85
CR8-A*-1*	1.00	0.40	0.45	0.55	0.80
CR8-A*-2*	1.00	0.45	0.50	0.60	0.80
CR8-A*-3*	1.00	0.27	0.36	0.45	0.77
DR10-A*-1*	1.00	0.25	0.28	0.37	0.63
DR10-A*-2*	1.00	0.41	0.50	0.55	0.75
DW-A*-50*-04	1.00	0.25	0.28	0.36	0.60
DW-A*-50*-M5	1.00	0.30	0.33	0.42	0.67

Proximity Sensor Terminology

Material Influence

The nominal sensing distance (Sn) is defined using precisely defined measuring conditions (See Operating Distance). Other conditions may result in a reduction of the operating distance. The table below shows the influence different target materials have on the operating distances of the sensors.

Material Influence					
Sensor Series	Target Material Value				
	Steel	Copper	Aluminum	Brass	Stainless Steel
DW-A*-50*-M8-001	1.00	0.27	0.33	0.41	0.72
DW-A*-50*-M8	1.00	0.27	0.33	0.41	0.72
DW-A*-50*-M12	1.00	0.25	0.30	0.40	0.70
DW-A*-50*-M18	1.00	0.26	0.30	0.40	0.67
DW-A*-50*-M18-002	1.00	0.26	0.30	0.40	0.67
DW-A*-50*-M30	1.00	0.35	0.40	0.45	0.66
DW-A*-50*-M30-002	1.00	0.35	0.40	0.45	0.66
DW-A*-50*P12	1.00	0.12	0.20	0.34	0.75
DW-A*-50*P8	1.00	0.22	0.26	0.39	0.66
DW-A*-51*-M8	1.00	0.44	0.47	0.55	0.77
DW-A*-51*-M8-001	1.00	0.44	0.47	0.55	0.77
DW-A*-51*-M12*	1.00	0.45	0.49	0.56	0.77
DW-A*-51*-M18	1.00	0.42	0.44	0.50	0.69
DW-A*-51*-M18-002	1.00	0.42	0.44	0.50	0.69
DW-A*-51*-M30	1.00	0.37	0.42	0.47	0.78
DW-A*-51*-M30-002	1.00	0.37	0.42	0.47	0.78
DW-A*-52x-M8	1.00	0.22	0.25	0.33	0.63
DW-A*-52x-M12	1.00	0.23	0.27	0.36	0.67
DW-A*-60*-M8*	1.00	0.20	0.25	0.35	0.70
DW-A*-60*-M12*	1.00	0.30	0.35	0.50	0.85
DW-A*-60*-M18*	1.00	0.30	0.35	0.45	0.75
DW-A*-60*-M30*	1.00	0.40	0.45	0.55	0.80
DW-A*-61*-M8*	1.00	0.50	0.50	0.60	0.80
DW-A*-61*-M12*	1.00	0.50	0.50	0.60	0.90
DW-A*-61*-M18*	1.00	0.40	0.40	0.50	0.70
DW-A*-61*-M30*	1.00	0.40	0.50	0.50	0.85
DW-A*-62*-03-96*	1.00	0.45	0.50	0.60	0.80
DW-A*-62*-03	1.00	0.45	0.50	0.60	0.80
DW-A*-62*-M4-96*	1.00	0.45	0.50	0.60	0.80
DW-A*-62*-M4	1.00	0.45	0.50	0.60	0.80
DW-A*-62*-M8*	1.00	0.30	0.30	0.45	0.70
DW-A*-62*-M12*	1.00	0.40	0.44	0.54	0.80
DW-A*-62*-M18*	1.00	0.30	0.35	0.40	0.70
DW-A*-63*-M8*	1.00	0.40	0.45	0.50	0.75
DW-A*-63*-M12*	1.00	0.45	0.70	0.55	0.75
DW-A*-63*-M18*	1.00	0.40	0.45	0.55	0.75
DW-A*-63*-M30*	1.00	0.40	0.70	0.50	0.60
DW-A*-70*-C23	1.00	0.80	1.00	1.20	0.85
DW-A*-70*-C23-276	1.00	0.80	1.00	1.20	0.85
DW-Ax-71x-04	1.00	0.95	1.00	1.35	0.40
DW-Ax-71x-M5	1.00	0.95	1.00	1.35	0.40

Proximity Sensor Terminology

Material influence

The nominal sensing distance (Sn) is defined using precisely defined measuring conditions (See Operating Distance). Other conditions may result in a reduction of the operating distance. The table below shows the influence different target materials have on the operating distances of the sensors.

Material Influence					
Sensor Series	Target Material Value				
	Steel	Copper	Aluminum	Brass	Stainless Steel
DW-A*-71*-M8	1.00	0.85	1.00	1.40	0.90
DW-A*-71*-M8-001	1.00	0.85	1.00	1.40	0.90
DW-A*-71*-M12	1.00	0.80	1.00	1.40	0.65
DW-A*-71*-M12-967	1.00	1.50	1.0	1.80	0/0
DW-A*-71*-M18-002	1.00	0.90	1.00	1.35	0.70
DW-A*-71*-M18	1.00	0.90	1.00	1.35	0.70
DW-A*-71*-M18-002	1.00	0.90	1.00	1.35	0.70
DW-A*-71*-M18-967	1.00	1.50	1.70	1.70	0/0.2
DW-A*-71*-M30	1.00	0.90	1.00	1.20	0.25
DW-A*-71*-M30-002	1.00	0.90	1.00	1.20	0.25
DW-A*-71*-M30-967	1.00	1.65	1.65	1.20	0/0
DW-AD-603-M10E-***	1.00	0	0	0.05	0.70
DW-AD-62*-03E-961	1.00	0.18	0.21	0.32	0.50
DW-HD-60*-M12-200	1.00	0.15	0.20	0.15	0.65
DW-HD-60*-M18-310	1.00	0.20	0.25	0.35	0.70
DW-HD-60*-M18-411	1.00	0.20	0.25	0.35	0.70
DW-HD-60*-M30-310	1.00	TBD	TBD	TBD	TBD
DW-HD-60*-M30-411	1.00	0.30	0.35	0.50	0.70
DW-HD-61*-M30-411	1.00	TBD	TBD	TBD	TBD
DW-HD-61*-M50-517	1.00	TBD	TBD	TBD	TBD
DW-HD-62*-M8-1**	1.00	≤ 0.15	≤ 0.15	0.25	0.60
DW-L*-70*-P12G	1.00	0.80	1.00	1.50	0/0
DW-L*-70*-P12G -embedded	1.00	-	0.60	0.70	0.80
LF40-**-*H	1.00	0.30	0.40	0.40	0.70
P8	1.00	0.25 to 0.45	0.30 to 0.45	0.35 to 0.50	0.60 to 1.00
PAE (1.5 mm)	1.00	0.20	0.25	0.35	0.70
PAE (2.5 mm)	1.00	0.5	0.5	0.6	0.8
PAK (5mm)	1.00	0.30	0.35	0.45	0.75
PAK (8mm)	1.00	0.40	0.4	0.5	0.7
PAM (2mm)	1.0	0.30	0.35	0.50	0.85
PAM (4mm)	1.00	0.5	0.5	0.6	0.8
PBE6	1.00	0.3	0.4	0.5	0.9
PBM6	1.00	0.3	0.4	0.5	0.9
PBK6	1.00	0.3	0.4	0.5	0.9
PBT6	1.00	0.3	0.4	0.5	0.9
PBK-A*-*H	1.00	0.00	0.10	0.20	0.50
PBM-A*-*H	1.00	0.10	0.30	0.30	0.60
PBT-A*-*H	1.00	0.30	0.40	0.40	0.70
PD1-A*-1*	1.00	0.45	0.50	0.55	0.80
PD1-A*-3*	1.00	0.40	0.40	0.50	0.75

Proximity Sensor Terminology

Mounting type

Flush (shielded/embeddable) proximity switches.

These proximity switches may be flush mounted regardless of the metal being used. For reliable operation, it is necessary to observe the minimum distances from adjacent metal targets.

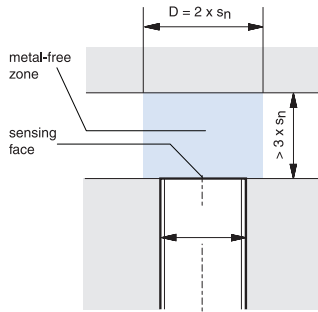

**Sn = Nominal sensing distance
(see Rated operating distance)**

Semi-flush (quasi-embeddable) proximity switches.

When mounting semi-flush proximity switches in conducting materials (metals), the unit can be almost flush, with a minimal protrusion (X = roughly 20% of the housing diameter) above the surface. See specific sensor for exact value.

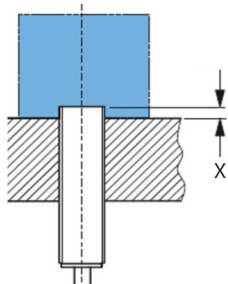

Non-flush (unshielded/non-embeddable) proximity switches.

When mounting non-flush proximity switches in conducting materials (metals), it is necessary to observe the minimum distances from adjacent metal targets. Flush mounting in non-conducting materials is permitted.

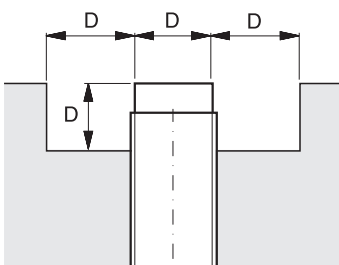

Off-state (leakage) current

This is the current that flows through the load circuit of the proximity switch in the OFF state at the maximum supply voltage.

Open collector

The output transistor is not internally connected to a pull-up or pull-down load. It is therefore possible to connect an external load supplied by an external voltage.

Operating distance (assured sensing range) (Sa)

The operating distance is the distance at which a standard target approaching the active face of the sensor causes a sensor output state change.

Output type and load connections – 3-wire NPN

There are two power wires and one output wire. The switching element is connected between the output wire and the negative terminal, and the load is connected between the output wire and the positive terminal. In the ON state, the current sinks from the load into the switching element.

Output type and load connections – 3-wire PNP

There are two power wires and one output wire. The switching element is connected between the output wire and the positive terminal, and the load is connected between the output wire and the negative terminal. In the ON state, the current flows from the switching element into the load.

Overvoltage protection

No damage will occur in the presence of surge pulses exceeding U_b and energy less than 0.5J.

Polarity reversing protection

No damage will occur to proximity switches if the supply wires are reversed.

Protection against inductive loads

Unless otherwise specified, DC sensors are protected against inductive overvoltage by use of a surge diode or a zener diode.

Unshielded proximity switches

The sensor housing does not cover the side of the sensing head. This type of sensor has a higher sensing range than the shielded type.

Rated insulation voltage (Ui)

Unless specified differently, all of the sensors with a supply voltage of up to 50VAC and 75VDC are tested at 500VAC.

Sensors with a supply voltage up to 250VAC are tested as follows:

- Class 1 (with earth terminal) at 1500VAC
- Class 2 (with double insulation, without earth terminal) at 3000VAC.

Nominal sensing distance — (Rated operating distance) (Sn)

This distance does not take into account manufacturing tolerances ($\pm 10\%$) or variations due to external conditions, such as voltages and temperatures not falling within the rated values.

Repeat accuracy (R)

The repeat accuracy of the effective operating distance (S_r) is measured over an eight hour period at an ambient temperature of 73°F ($\pm 9^\circ$) [23°C ($\pm 5^\circ$)] at a specified humidity and with a specified supply voltage. The difference between the measurements shall not exceed the specified value, or if not specified, 10% of S_n .

Ripple

This is given as a percentage of the mean supply voltage. It is the maximum peak-to-peak value of the admitted ripple voltage. A ripple voltage of $< 10\% U_b$ is desirable.

Proximity Sensor Terminology

Shocks

- In accordance with IEC 60068-2-27
- Pulse shape: half-sine
- Peak acceleration: 30g
- Pulse duration: 11 ms

Short-circuit protection

All DC sensors have integrated short-circuit protection. AC sensors should be protected externally by such devices as fuses.

No load supply (current consumption)

Amount of current consumed by sensor when output is not energized.

Standard target

A standard target is square, 1mm thick, and made from type FE360 carbon steel. The length of the side of the square is equal to the diameter of the sensor's active surface, or three times the rated operating distance (S_n), whichever is greater.

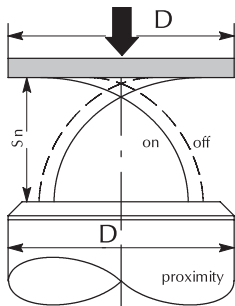

Nominal Sensing Distance

Switching frequency (f)

Switching frequency is the maximum output switching frequency performed by the output circuit when standard targets cross the sensing field at a distance of $S_n/2$. The targets are spaced $2d$.

- For DC sensors, the minimum output pulse width must not fall below $50 \mu\text{s}$.
- For AC sensors, the minimum output pulse must not fall below half a sine period (ie. for 60 Hz, $1/60 \div 2 = 8.33 \text{ ms}$.)

Temperature range

Unless otherwise specified, the minimum temperature range is -13 to $+158^\circ\text{F}$ [-25 to $+70^\circ\text{C}$].

Turn-on time

Turn-on time is the elapsed time from when the target enters the sensing range until the output switches.

Turn-off time

Turn-off time is the elapsed time from when the target is removed until the output switches.

Operating voltage (U_b)

Supply voltage range for safe and correct sensor operation.

Operating (load) Current

Maximum current the sensor output is capable of switching.

Voltage drop (U_d)

This is the voltage measured across the active output of the proximity switch when the rated operational current (I_e) flows in the load at the rated supply voltage and the temperature is at 73°F ($\pm 9^\circ$) [23°C ($\pm 5^\circ$)]. Unless specified differently, the following values are guaranteed:

- Two-wire DC models $< 8 \text{ VDC}$
- Three-wire DC models $< 3.5 \text{ VDC}$
- Two-wire AC models < 10

Vibration

In accordance with IEC 60868-2-6

Frequency range: 10-55 Hz

Amplitude: 1mm

Sweep cycle duration: 5 min.

Duration of endurance at 55 Hz: 30 min. in each of the three axis directions

4-wire NPN or PNP (complementary outputs)

There are two power wires: one normally open output wire and one normally closed output wire.

4-wire NPN and PNP

There are two power wires, and the output type is wiring programmable. An NPN output is available by connecting the PNP terminal to the negative power supply line. A PNP output is available by connecting the NPN terminal to the positive power supply line.

Time delay before availability (t_v)

The time delay before availability is the time between the switching on of the supply voltage and the instant at which the sensor becomes ready to operate correctly.

During the reset the output circuit is in OFF-state; false signal may be present but the duration shall not exceed 2 ms. If not specified otherwise, the reset duration doesn't exceed 300 ms.

Field Device Examples – 3-Wire Connections

NPN (Sinking) Field Device Example

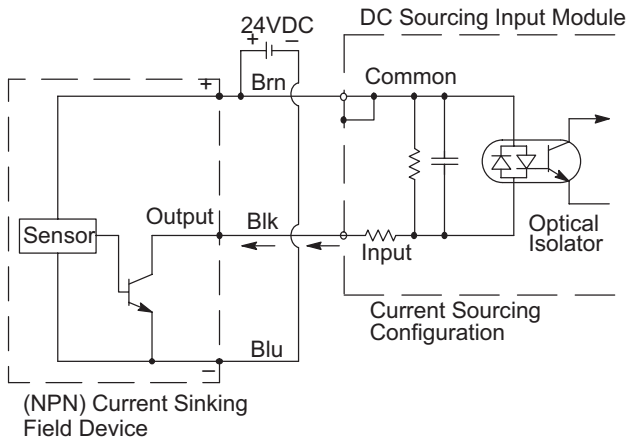

PNP (Sourcing) Field Device Example

