

AE1/AE6 Series Inductive Proximity Sensors



M8 (8mm) metal – DC

- Compact metal housing
- Axial cable, M8 or M12 quick-disconnect models
- Complete overload protection
- IP67 rated
- LED status indicators are visible 360° around the cylinder
- Lifetime warranty



AE1 Series Standard Length M8 DC Inductive Proximity Selection Chart

Part Number	Price	Sensing Range	Mounting	Output State	Logic	Connection	Wiring	Dimensions
Standard Distance								
AE1-AN-1A	\$18.50	0-1.5 mm [0-0.06 in]	Flush	N.O.	NPN	2m [6.5 ft] axial cable	Diagram 1	Figure 1
AE1-AP-1A	\$18.50		Flush	N.O.	PNP	2m [6.5 ft] axial cable	Diagram 2	Figure 1
AE1-AN-1H	\$18.50		Flush	N.O.	NPN	M12 [12mm] connector	Diagram 3	Figure 2
AE1-AP-1H	\$18.50		Flush	N.O.	PNP	M12 [12mm] connector	Diagram 4	Figure 2
AE1-AN-1F	\$18.50		Flush	N.O.	NPN	M8 [8mm] connector	Diagram 3	Figure 3
AE1-AP-1F	\$18.50		Flush	N.O.	PNP	M8 [8mm] connector	Diagram 4	Figure 3
AE1-AN-2A	\$18.50	0-2.5 mm [0-0.098 in]	Non-flush	N.O.	NPN	2m [6.5 ft] axial cable	Diagram 1	Figure 1
AE1-AP-2A	\$25.00		Non-flush	N.O.	PNP	2m [6.5 ft] axial cable	Diagram 2	Figure 1
AE1-AN-2H	\$18.50		Non-flush	N.O.	NPN	M12 [12mm] connector	Diagram 3	Figure 2
AE1-AP-2H	\$25.00		Non-flush	N.O.	PNP	M12 [12mm] connector	Diagram 4	Figure 2
AE1-AN-2F	\$18.50		Non-flush	N.O.	NPN	M8 [8mm] connector	Diagram 3	Figure 3
AE1-AP-2F	\$18.50		Non-flush	N.O.	PNP	M8 [8mm] connector	Diagram 4	Figure 3
Extended Distance								
AE1-AN-3A	\$24.00	0-2 mm [0-0.08 in]	Flush	N.O.	NPN	2m [6.5 ft] axial cable	Diagram 1	Figure 1
AE1-AP-3A	\$24.00		Flush	N.O.	PNP	2m [6.5 ft] axial cable	Diagram 2	Figure 1
AE1-AN-3F	\$31.00		Flush	N.O.	NPN	M8 [8mm] connector	Diagram 3	Figure 3
AE1-AP-3F	\$24.00		Flush	N.O.	PNP	M8 [8mm] connector	Diagram 4	Figure 3
AE1-AN-4A	\$24.00	0-4 mm [0-0.157 in]	Non-flush	N.O.	NPN	2m [6.5 ft] axial cable	Diagram 1	Figure 1
AE1-AP-4A	\$31.00		Non-flush	N.O.	PNP	2m [6.5 ft] axial cable	Diagram 2	Figure 1
AE1-AN-4F	\$24.00		Non-flush	N.O.	NPN	M8 [8mm] connector	Diagram 3	Figure 3
AE1-AP-4F	\$24.00		Non-flush	N.O.	PNP	M8 [8mm] connector	Diagram 4	Figure 3
Triple Distance								
AE1-AN-5A	\$75.00	0-3 mm [0-0.118 in]	Semi-flush	N.O.	NPN	2m [6.5 ft] axial cable	Diagram 1	Figure 1
AE1-AP-5A	\$75.00		Semi-flush	N.O.	PNP	2m [6.5 ft] axial cable	Diagram 2	Figure 1
AE1-AN-5F	\$75.00		Semi-flush	N.O.	NPN	M8 [8mm] connector	Diagram 3	Figure 4
AE1-AP-5F	\$75.00		Semi-flush	N.O.	PNP	M8 [8mm] connector	Diagram 4	Figure 4

AE6 Series Short Body M8 DC Inductive Prox Selection Chart

Part Number	Price	Sensing Range	Mounting	Output State	Logic	Connection	Wiring	Dimensions
Extended Distance								
AE6-AN-3A	\$28.00	0-2 mm [0-0.08 in]	Flush	N.O.	NPN	2m [6.5 ft] axial cable	Diagram 1	Figure 5
AE6-AP-3A	\$28.00		Flush	N.O.	PNP	2m [6.5 ft] axial cable	Diagram 2	Figure 5
AE6-AN-3F	\$37.50		Flush	N.O.	NPN	M8 [8mm] connector	Diagram 3	Figure 6
AE6-AP-3F	\$28.00		Flush	N.O.	PNP	M8 [8mm] connector	Diagram 4	Figure 6
AE6-AN-4A	\$28.00	0-4 mm [0-0.157 in]	Non-flush	N.O.	NPN	2m [6.5 ft] axial cable	Diagram 1	Figure 5
AE6-AP-4A	\$28.00		Non-flush	N.O.	PNP	2m [6.5 ft] axial cable	Diagram 2	Figure 5
AE6-AN-4F	\$37.50		Non-flush	N.O.	NPN	M8 [8mm] connector	Diagram 3	Figure 6
AE6-AP-4F	\$28.00		Non-flush	N.O.	PNP	M8 [8mm] connector	Diagram 4	Figure 6

AE1/AE6 Series Inductive Proximity Sensors

AE Series Specifications					
Specification	Standard Distance Models		Extended Distance Models		Triple Distance Models
Mounting Type	Flush	Non-flush	Flush	Non-flush	Semi-flush
Nominal Sensing Distance	1.5 mm [0.06 in]	2.5 mm [0.098 in]	2mm [0.08 in]	4mm [0.157 in]	3mm [0.118 in]
Operating Distance	NA				
Material Correction Factors	See the Material influence table				
Output Type	NPN or PNP/N.O. only/3-wire				
Operating Voltage	10 to 30 VDC				
No-load Supply Current	≤ 20 mA		≤ 10 mA		
Operating (Load) Current	≤ 200 mA				
Off-state (Leakage) Current	≤ 10µA		≤ 120µA		
Voltage Drop	≤ 1.2 V				≤ 2.0 V
Switching Frequency	3kHz	2.5 kHz	3kHz	1kHz	
Differential Travel (% of Nominal Distance)	2 to 10%		1 to 20%		m 10%
Repeat Accuracy	≤ 2%		≤ 5 %		
Ripple	≤ 10%				≤ 20%
Time Delay Before Availability (tv)	100ms (5 ms for AE6 short body models)				50ms
Reverse Polarity Protection	Yes				
Short-Circuit Protection	Yes (switch auto-resets after overload is removed)				
Operating Temperature	-25 to +70°C [-13 to 158°F]				
Protection Degree (DIN 40050)	IEC IP67				
Indication/Switch Status	Yellow (output energized)				
Housing Material	Nickel-plated brass			Chrome-plated brass	
Sensing Face Material	Polybutylene Terephthalate (PBT)				
Shock/Vibration	See Proximity Sensor Terminology				
Tightening Torque	4 Nm (2.95 lb-ft)				
Weight (cable/M8 connector/M12 connector)	43g [1.52 oz]/16g [0.56 oz]/20g [0.71 oz]			54g [1.90 oz]/26g [0.92 oz]/(NA)	
Connection	2 meter [6.5 ft] PVC axial cable / M8 connector / M12 connector				
Agency Approvals	NA			UL file E328811	

To obtain the most current agency approval information, see the Agency Approval Checklist section on the specific part number's web page.

Wiring Diagrams

Diagram 1

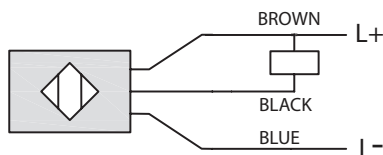

Diagram 2

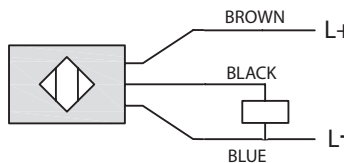

Diagram 3

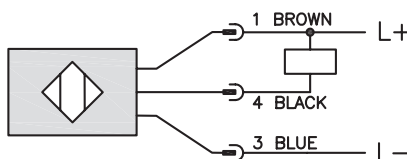
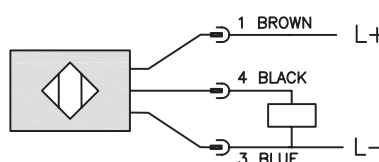
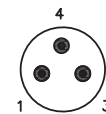

Diagram 4



Connectors

M8 connector



M12 connector

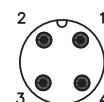

AE1/AE6 Series Inductive Proximity Sensors

Dimensions

mm [inch]

Figure 1

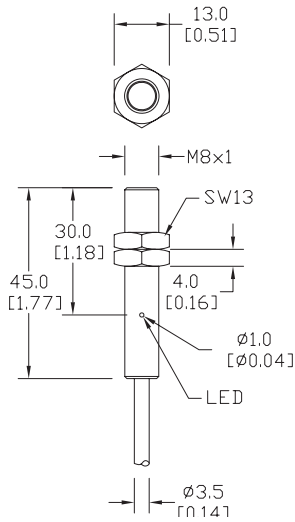

Figure 2

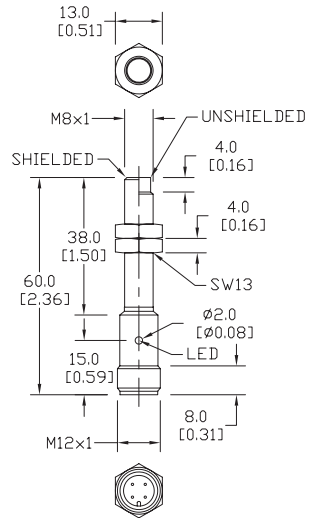

Figure 3

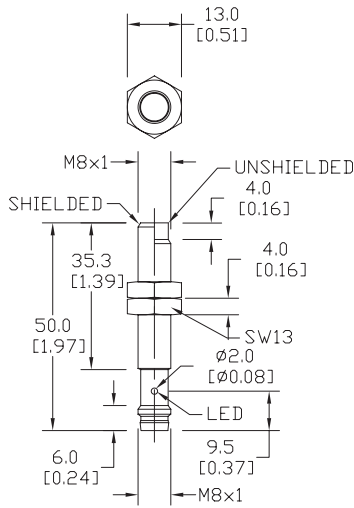

Figure 4

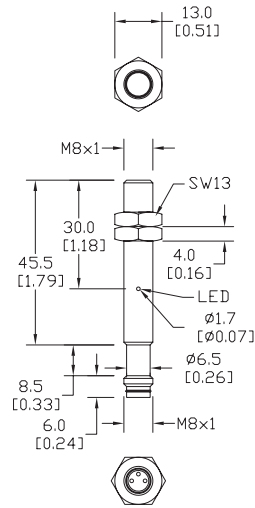

Figure 5

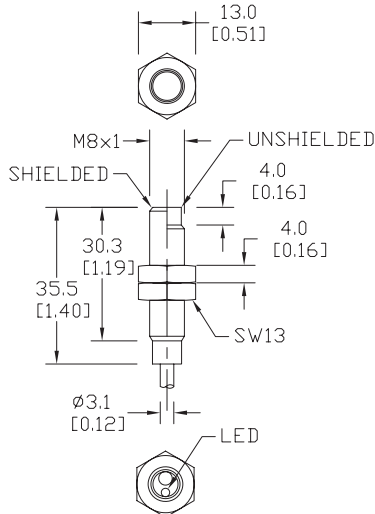
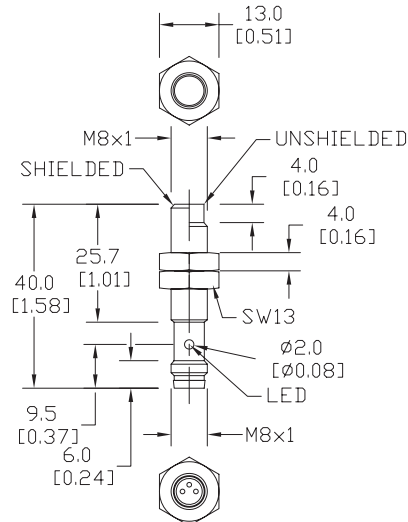

Figure 6



See our website: www.AutomationDirect.com for complete Engineering Drawings.

Accessories for 8mm Sensors

Axial Mounting Bracket

Mounting bracket, axial, zinc-plated steel. For use with 8mm sensors. Has two mounting holes (use 3 mm screws) and allows the rotation of an optical axis for axial sensors. Hexagonal nuts not included.

Accessories for 8mm Sensors				
Part Number	Price	Description	Drawing Link	Weight [lb]
ST08A	\$2.00	Micro Detectors mounting bracket, axial, zinc plated steel. For use with 8mm sensors.	PDF	0.04



[ST08A](#)

Right-angle Mounting Bracket

Mounting bracket, right-angle, zinc-plated steel. For use with 8mm sensors. Has two mounting holes (use 3mm screws) and allows the rotation of an optical axis for right-beam-angle-adaptor sensors. Hexagonal nuts not included.

Accessories for 8mm Sensors				
Part Number	Price	Description	Drawing Link	Weight [lb]
ST08C	\$2.00	Micro Detectors mounting bracket, right-angle, zinc plated steel. For use with 8mm sensors.	PDF	0.04



[ST08C](#)

Accessories for 8mm Sensors

Right-angle Mounting Bracket

Mounting bracket, right-angle, plastic. For use with 8mm sensors.

Accessories for 8mm Sensors				
Part Number	Price	Description	Drawing Link	Weight [lb]
OPT2101	\$8.00	Wenglor mounting bracket, right-angle, plastic. For use with 8mm sensors.	PDF	0.02



[OPT2101](#)

Right-angle Swivel Mounting Systems

Mounting bracket, right-angle swivel, 360 degree vertical and horizontal adjustment. For use with 8mm sensors. Available in all stainless steel or with an aluminum head and stainless steel mounting plate.

Accessories for 8mm Sensors						
Part Number	Price	Description	Mounting Head	Mounting Plate	Drawing Link	Weight [lb]
OPT2112	\$11.50	Wenglor mounting bracket, right-angle swivel, 360 degree vertical and horizontal adjustment, aluminum, 12mm rod mount. For use with 8mm sensors.	Aluminum	304 Stainless Steel	PDF	0.14
OPT2113	\$21.00	Wenglor mounting bracket, right-angle swivel, 360 degree vertical and horizontal adjustment, 304 stainless steel, 12mm rod mount. For use with 8mm sensors.	304 Stainless Steel	304 Stainless Steel	PDF	0.26



[OPT2112 & OPT2113](#)

Note: 304 Stainless steel mounting rods sold separately: [OPT2109](#) (200mm length), [OPT2110](#) (300mm length), and [OPT2111](#) (500mm length).

Mounting Rods and Brackets

Mounting Rods

304 Stainless steel rods for mounting swivel brackets [OPT2112](#) - [OPT2127](#). Available in three lengths: 200mm, 300mm, and 500mm. 12mm diameter.

Mounting Rods for OPT2112-2127 Swivel Mounting Brackets				
Part Number	Price	Description	Drawing Link	Weight lb (g)
OPT2109	\$13.00	Wenglor mounting rod, 12mm diameter, 200mm length, 304 stainless steel.	PDF	0.41 [185.97]
OPT2110	\$16.00	Wenglor mounting rod, 12mm diameter, 300mm length, 304 stainless steel.	PDF	0.60 [272.16]
OPT2111	\$21.00	Wenglor mounting rod, 12mm diameter, 500mm length, 304 stainless steel.	PDF	0.98 [444.52]



Right-angle Mounting Bracket

Mounting bracket, right-angle, nickel-plated brass. For use with 12mm mounting rods [OPT2109](#), [OPT2110](#) & [OPT2111](#).

Right-angle Mounting Brackets for 12mm Sensors				
Part Number	Price	Description	Drawing Link	Weight lb [g]
OPT2108	\$16.00	Wenglor mounting bracket, right-angle, nickel-plated brass. For use with 12mm mounting rods OPT2109 , OPT2110 & OPT2111 .	PDF	0.07 [31.8]

