



DW Series 5mm Triple Sensing Proximity Sensors



Miniature M5 (5mm) nickel silver– DC

- 5mm triple distance proximity sensor
- Complete overload protection
- IP67 rated
- Two M5 lock nuts included
- Nickel silver construction
- LED status indicator
- Lifetime warranty



DW Series 5mm Triple Distance Inductive Proximity Selection Chart

Part Number	Price	Size	Sensing Range	Mounting	Output State	Logic	Connection	Wiring	Dimensions
Triple Distance									
DW-AD-501-M5	\$99.00	M5	2.5 mm [0.098 in]	Semi-flush	N.O.	NPN	2m [6.5 ft] axial cable	Diagram 1	Figure 1
DW-AD-503-M5	\$99.00	M5	2.5 mm [0.098 in]	Semi-flush	N.O.	PNP	2m [6.5 ft] axial cable	Diagram 2	Figure 1
DW-AS-501-M5	\$99.00	M5	2.5 mm [0.098 in]	Semi-flush	N.O.	NPN	M8 quick-disconnect	Diagram 3	Figure 2
DW-AS-503-M5	\$99.00	M5	2.5 mm [0.098 in]	Semi-flush	N.O.	PNP	M8 quick-disconnect	Diagram 4	Figure 2
DW-AD-502-M5	\$99.00	M5	2.5 mm [0.098 in]	Semi-flush	N.C.	NPN	2m [6.5 ft] axial cable	Diagram 1	Figure 1
DW-AD-504-M5	\$99.00	M5	2.5 mm [0.098 in]	Semi-flush	N.C.	PNP	2m [6.5 ft] axial cable	Diagram 2	Figure 1
DW-AS-502-M5	\$99.00	M5	2.5 mm [0.098 in]	Semi-flush	N.C.	NPN	M8 quick-disconnect	Diagram 3	Figure 2
DW-AS-504-M5	\$99.00	M5	2.5 mm [0.098 in]	Semi-flush	N.C.	PNP	M8 quick-disconnect	Diagram 4	Figure 2

DW Series 5mm Triple Distance Inductive Proximity Specifications

Specifications	DW-Ax-50x-M5
Mounting Type	Semi-flush
Nominal Sensing Distance	2.5 mm
Operating Distance	–
Material Correction Factors	See the Material influence table
Output Type	NPN or PNP, N.O. or N.C.
Operating Voltage	10 to 30 VDC
No-load Supply Current	≤ 10mA
Operating (Load) Current	≤ 200mA
Off-state (Leakage) Current	≤ 0.1 mA
Voltage Drop	≤ 2V
Switching Frequency	≤ 800Hz
Differential Travel (% of Nominal Distance)	≤10%
Repeat Accuracy	0.03 mm
Ripple	≤ 20%
Time Delay Before Availability (tv)	≤ 30ms
Reverse Polarity Protection	Yes
Short-Circuit Protection	Yes
Operating Temperature	-25 to 70°C [-13 to 158°F]
Protection Degree (DIN 40050)	IP67
Indication/Switch Status	Yellow LED
Housing Material	Nickel silver
Sensing Face Material	PPE [Noryl]
Shock/Vibration	IEC 60947-5-2/7.4
Tightening Torque	–
Weight	33g [1.16 oz], 5g [0.18 oz]
Connection	2m [6.5 ft] cable, M8 connection
IO-Link	–
Agency Approvals	CE, cULus E239373

Note: To obtain the most current agency approval information, see the Agency Approval Checklist section on the specific part number's web page.

DW Series 5mm Triple Sensing Proximity Sensors

Dimensions

mm [inches]

Figure 1

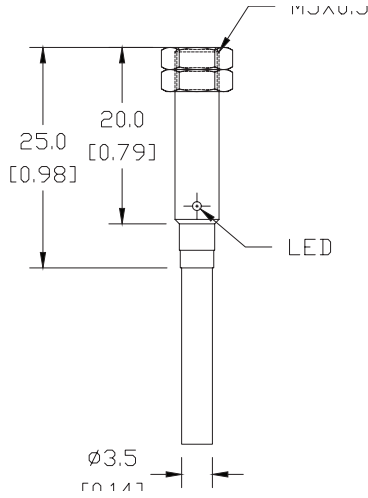
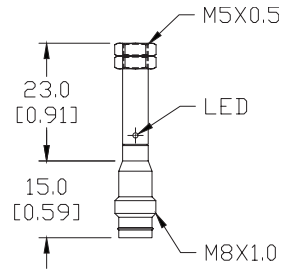

Figure 2



Wiring Diagrams

Diagram 1

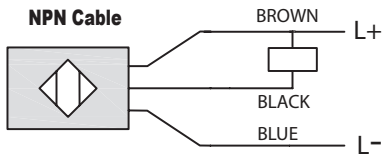
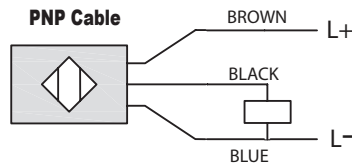

Diagram 2



Connectors

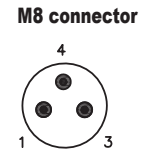

Diagram 3

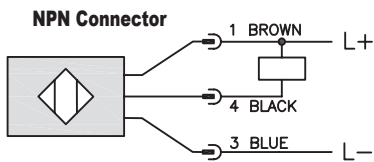
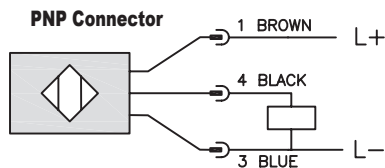

Diagram 4



Accessories for 5mm Sensors

Right-angle Mounting Bracket

Mounting bracket, right-angle, plastic. For use with 5mm sensors.

Accessories for 5mm Sensors				
Part Number	Price	Description	Drawing Link	Weight [lb]
OPT2100	\$8.00	Wenglor mounting bracket, right-angle, plastic. For use with 5mm sensors.	PDF	0.02



[OPT2100](#)