

PNK Series Inductive Proximity Sensors



M18 (18mm) Bronze-plated Brass - DC

- Low cost/high performance
- Short and regular body styles
- IP65 / IP66 / IP67 / IP68 / IP69K rated
- Axial cable / M12 quick-disconnect; purchase cable separately
- Lifetime warranty



PNK Series Inductive Proximity Selection Chart (Short Body)

Part Number	Price	Sensing Range	Mounting	Output State	Logic	Connection	Wiring	Dimensions
M18 Models (short body)								
<u>PNK6-AN-3A</u>	\$23.50	8mm [0.32 in]	Flush	N.O.	NPN	2m [6.5 ft] axial cable	Diagram 1	Figure 5
<u>PNK6-AN-3H</u>	\$23.50	8mm [0.32 in]	Flush	N.O.	NPN	M12 (12mm) connector	Diagram 1	Figure 6
<u>PNK6-AN-4A</u>	\$23.50	12mm [0.47 in]	Non-flush	N.O.	NPN	2m [6.5 ft] axial cable	Diagram 1	Figure 5
<u>PNK6-AN-4H</u>	\$23.50	12mm [0.47 in]	Non-flush	N.O.	NPN	M12 (12mm) connector	Diagram 1	Figure 6
<u>PNK6-AP-3A</u>	\$23.50	8mm [0.32 in]	Flush	N.O.	PNP	2m [6.5 ft] axial cable	Diagram 2	Figure 5
<u>PNK6-AP-3H</u>	\$23.50	8mm [0.32 in]	Flush	N.O.	PNP	M12 (12mm) connector	Diagram 2	Figure 6
<u>PNK6-AP-4A</u>	\$23.50	12mm [0.47 in]	Non-flush	N.O.	PNP	2m [6.5 ft] axial cable	Diagram 2	Figure 5
<u>PNK6-AP-4H</u>	\$23.50	12mm [0.47 in]	Non-flush	N.O.	PNP	M12 (12mm) connector	Diagram 2	Figure 6
<u>PNK6-CN-3A</u>	\$23.50	8mm [0.32 in]	Flush	N.C.	NPN	2m [6.5 ft] axial cable	Diagram 3	Figure 5
<u>PNK6-CN-3H</u>	\$23.50	8mm [0.32 in]	Flush	N.C.	NPN	M12 (12mm) connector	Diagram 3	Figure 6
<u>PNK6-CN-4A</u>	\$23.50	12mm [0.47 in]	Non-flush	N.C.	NPN	2m [6.5 ft] axial cable	Diagram 3	Figure 5
<u>PNK6-CN-4H</u>	\$23.50	12mm [0.47 in]	Non-flush	N.C.	NPN	M12 (12mm) connector	Diagram 3	Figure 6
<u>PNK6-CP-3A</u>	\$23.50	8mm [0.32 in]	Flush	N.C.	PNP	2m [6.5 ft] axial cable	Diagram 4	Figure 5
<u>PNK6-CP-3H</u>	\$23.50	8mm [0.32 in]	Flush	N.C.	PNP	M12 (12mm) connector	Diagram 4	Figure 6
<u>PNK6-CP-4A</u>	\$23.50	12mm [0.47 in]	Non-flush	N.C.	PNP	2m [6.5 ft] axial cable	Diagram 4	Figure 5
<u>PNK6-CP-4H</u>	\$23.50	12mm [0.47 in]	Non-flush	N.C.	PNP	M12 (12mm) connector	Diagram 4	Figure 6

PNK Series Inductive Proximity Selection Chart (Regular Body)

Part Number	Price	Sensing Range	Mounting	Output State	Logic	Connection	Wiring	Dimensions
M18 Models (regular body)								
<u>PNK-AN-3A</u>	\$25.00	8mm [0.32 in]	Flush	N.O.	NPN	2m [6.5 ft] axial cable	Diagram 1	Figure 7
<u>PNK-AN-3H</u>	\$25.00	8mm [0.32 in]	Flush	N.O.	NPN	M12 (12mm) connector	Diagram 1	Figure 8
<u>PNK-AN-4A</u>	\$25.00	12mm [0.47 in]	Non-flush	N.O.	NPN	2m [6.5 ft] axial cable	Diagram 1	Figure 7
<u>PNK-AN-4H</u>	\$25.00	12mm [0.47 in]	Non-flush	N.O.	NPN	M12 (12mm) connector	Diagram 1	Figure 8
<u>PNK-AP-3A</u>	\$25.00	8mm [0.32 in]	Flush	N.O.	PNP	2m [6.5 ft] axial cable	Diagram 2	Figure 7
<u>PNK-AP-3H</u>	\$25.00	8mm [0.32 in]	Flush	N.O.	PNP	M12 (12mm) connector	Diagram 2	Figure 8
<u>PNK-AP-4A</u>	\$25.00	12mm [0.47 in]	Non-flush	N.O.	PNP	2m [6.5 ft] axial cable	Diagram 2	Figure 7
<u>PNK-AP-4H</u>	\$25.00	12mm [0.47 in]	Non-flush	N.O.	PNP	M12 (12mm) connector	Diagram 2	Figure 8
<u>PNK-CN-3H</u>	\$25.00	8mm [0.32 in]	Flush	N.C.	NPN	M12 (12mm) connector	Diagram 3	Figure 8
<u>PNK-CN-4A</u>	\$25.00	12mm [0.47 in]	Non-flush	N.C.	NPN	2m [6.5 ft] axial cable	Diagram 3	Figure 7
<u>PNK-CN-4H</u>	Retired	12mm [0.47 in]	Non-flush	N.C.	NPN	M12 (12mm) connector	Diagram 3	Figure 8
<u>PNK-CP-3A</u>	\$25.00	8mm [0.32 in]	Flush	N.C.	PNP	2m [6.5 ft] axial cable	Diagram 4	Figure 7
<u>PNK-CP-3H</u>	Retired	8mm [0.32 in]	Flush	N.C.	PNP	M12 (12mm) connector	Diagram 4	Figure 8
<u>PNK-CP-4A</u>	\$25.00	12mm [0.47 in]	Non-flush	N.C.	PNP	2m [6.5 ft] axial cable	Diagram 4	Figure 7
<u>PNK-CP-4H</u>	\$25.00	12mm [0.47 in]	Non-flush	N.C.	PNP	M12 (12mm) connector	Diagram 4	Figure 8

PN Series Inductive Proximity Sensors

PN Series Specifications			
Sensor	M12 Models (PNM)	M18 Models (PNK)	M30 Models (PNT)
Mounting Type	Flush or Non-flush		
Nominal Sensing Distance	Flush: 4mm [0.16 in] Non-flush: 7mm [0.28 in]	Flush: 8mm [0.31 in] Non-flush: 12mm [0.47 in]	Flush: 15mm [0.6 in] Non-flush: 22mm [0.79 in]
Operating Distance	Flush: 0 to 3.24 mm Non-flush: 0 to 5.67 mm	Flush: 0 to 6.48 mm Non-flush: 0 to 9.72 mm	Flush: 0 to 12.15 mm Non-flush: 0 to 17.82 mm
Material Correction Factors	See the Material influence table		
Output Type	NPN or PNP, N.O. or N.C.		
Operating Voltage	10 to 30 VDC		
No-load Supply Current	<10 mA		
Operating (Load) Current	100mA		
Off-state (Leakage) Current	For 3-wire [< 50µ]		
Voltage Drop	<2.5 V		
Switching Frequency	700Hz	Flush 400Hz; Non-flush 300Hz	100Hz
Differential Travel (% of Nominal Distance)	3 - 15		
Repeat Accuracy	< 10%		
Ripple	NA		
Time Delay Before Availability (tv)	NA		
Reverse Polarity Protection	Yes		
Short-circuit Protection	Yes, pulsed		
Operating Temperature	-40 to 85°C [-40 to 185°F]		
Protection Degree (DIN 40050)	IP65, IP66, IP67, IP68, IP69K		
Indication/Switch Status	Yellow (output energized), 1 LED prewired/4 LEDs for quick disconnect		
Housing Material	Housing: brass, bronze-plated; PEI; Lock nuts: brass		
Sensing Face Material	Polybutylene Terephthalate [PBT]		
Shock/Vibration	See Proximity Sensor Terminology		
Tightening Torque	Connector type: 7Nm [1.57 lb-ft] Cable type: 12Nm [2.70 lb-ft]	25 Nm [5.62 lb-ft]	50Nm [11.21 lb-ft]
Weight	NA		
Connectors	M12 connector/2m [6.5 ft] axial cable. 2 lock nuts included		
Agency Approvals	M12 Connector versions cULus file E328811, CE, RoHS; Cable versions UL file E328811, CE, RoHS		

To obtain the most current agency approval information, see the Agency Approval Checklist section on the specific part number's web page.

Wiring diagrams

Diagram 1

NPN Output

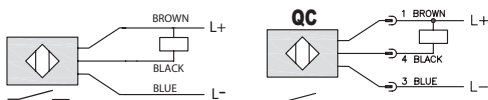
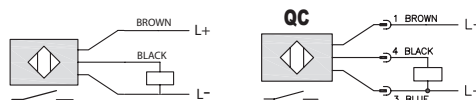

Diagram 2

PNP Output



Connector

M12 connector

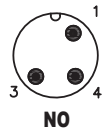

Diagram 3

NPN Output

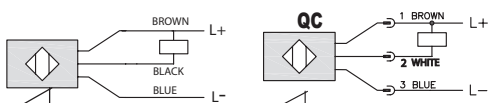
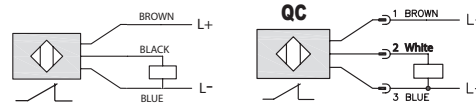
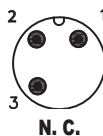

Diagram 4

PNP Output



M12 connector



***Note: Use M12 4 connector cable. M12 3 connector cable will not work for normally closed units.**

PN Series Inductive Proximity Sensors

Dimensions

mm [inches]

Figure 1

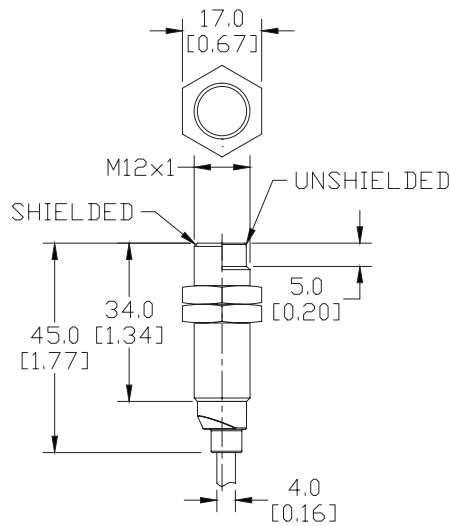

Figure 2

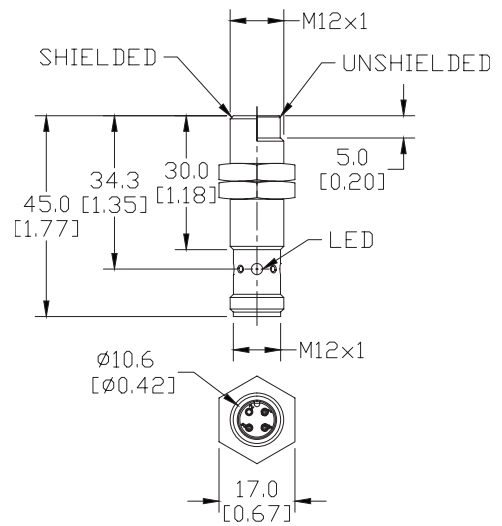

Figure 3

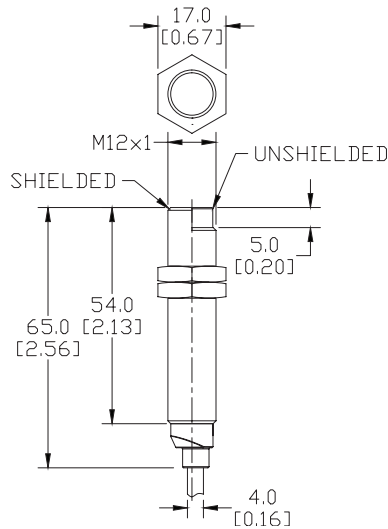

Figure 4

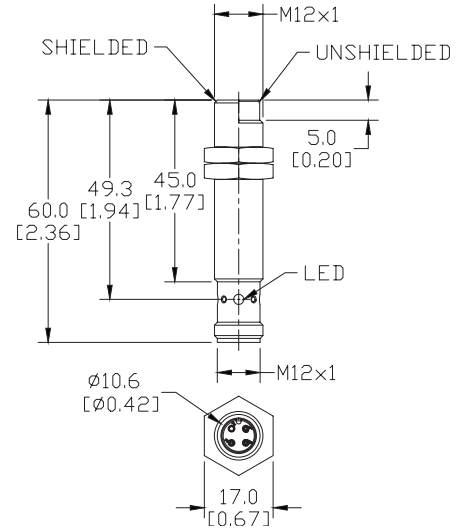

Figure 5

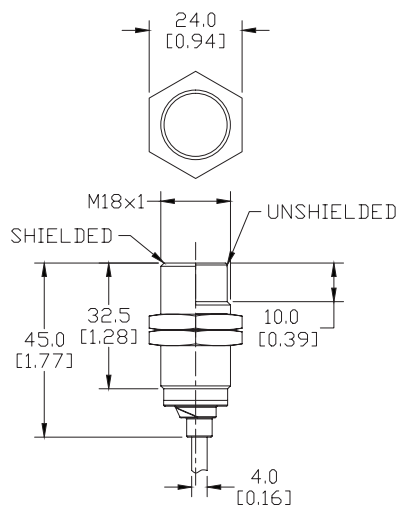
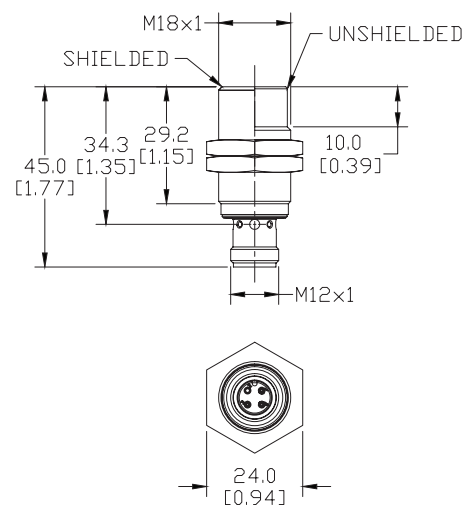

Figure 6



PN Series Inductive Proximity Sensors

Figure 7

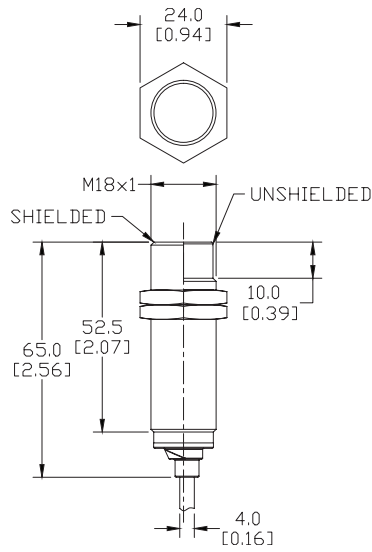

Figure 9

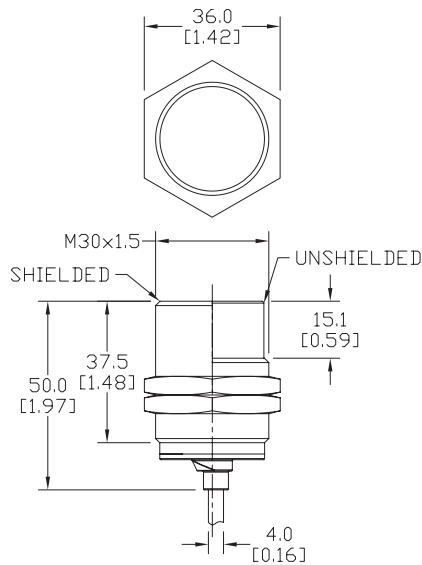

Figure 11

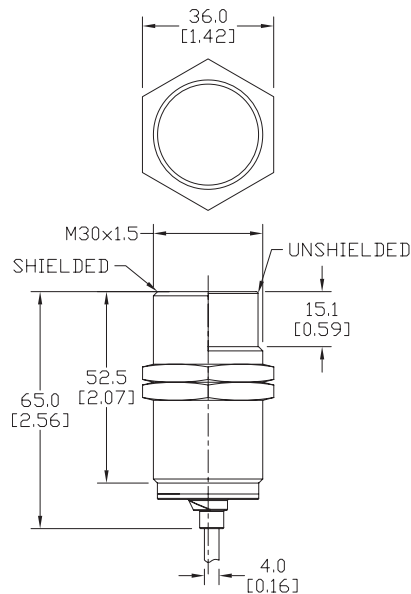

Figure 8

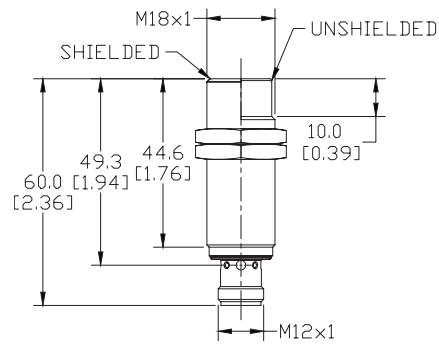

Figure 10

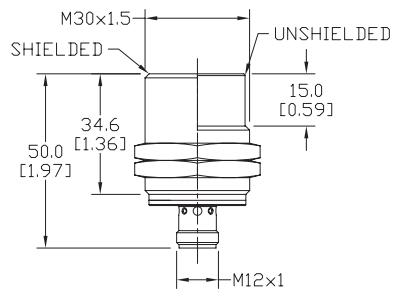
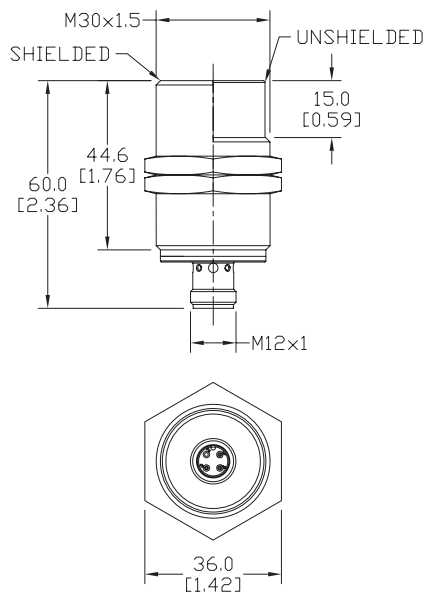

Figure 12



Accessories for 18mm Sensors

Axial Mounting Bracket

Axial mounting bracket available in zinc plated steel or 316L stainless steel. Has two mounting holes (use 4mm screws) and allows for rotation of an optical axis for right-beam-angle-adaptor sensors. Hexagonal nuts not included. For use with 18mm sensors.



ST18A

Accessories for 18mm Sensors			
Part Number	Price	Description	Weight lb [g]
ST18A	\$2.00	Micro Detectors mounting bracket, axial, zinc plated steel. For use with 18mm sensors.	0.06 [27.2]
ST18A7W	\$7.25	Micro Detectors mounting bracket, axial, 316L stainless steel. For use with 18mm sensors.	0.06 [27.2]

Dimensions

mm [inches]

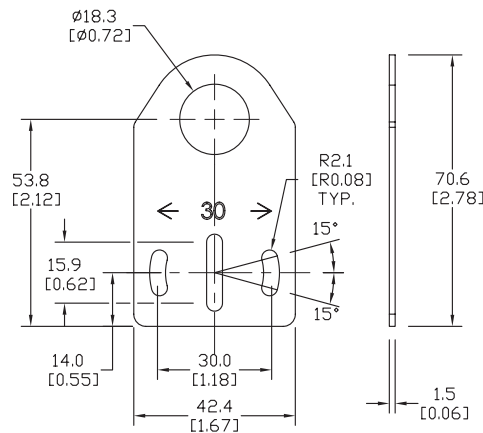

Right-angle Mounting Bracket

Right-angle mounting bracket for use with 18mm sensors. Has two mounting holes (use 4mm screws) and allows the rotation of an optical axis for axial sensors. Hexagonal nuts not included.

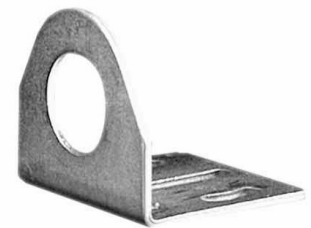

ST18C

Accessories for 18mm Sensors			
Part Number	Price	Description	Weight lb [g]
ST18C	\$2.00	Micro Detectors mounting bracket, right-angle, zinc plated steel. For use with 18mm sensors.	0.06 [27.2]
ST18C7W	\$7.25	Micro Detectors mounting bracket, right-angle, 316L stainless steel. For use with 18mm sensors.	0.06 [27.2]

Dimensions

mm [inches]

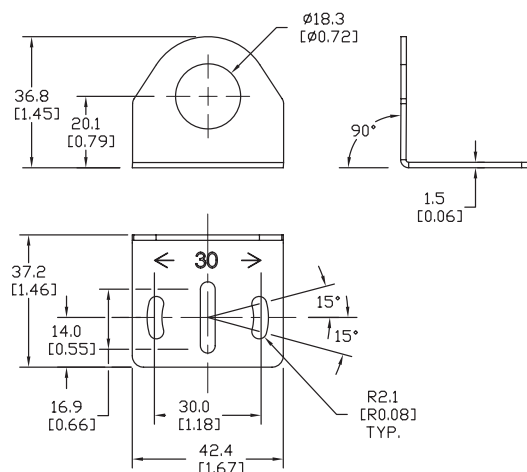

Accessories for 18mm Sensors

Right-angle Mounting Brackets

Mounting bracket, right-angle, fixed insertion stop adjustment, plastic. For use with 18mm sensors. Available with or without fixed insertion stop.

Accessories for 18mm Sensors				
Part Number	Price	Description	Drawing Link	Weight lb [g]
OPT2104	\$10.50	Wenglor mounting bracket, right-angle, fixed insertion stop adjustment, plastic. For use with 18mm sensors.	PDF	0.06 [27.2]
OPT2105	\$10.50	Wenglor mounting bracket, right-angle, plastic. For use with 18mm sensors.	PDF	0.06 [27.2]



[OPT2104](#), [OPT2105](#)

Right-angle Swivel Mounting Systems

Mounting bracket, right-angle swivel, 360 degree vertical and horizontal adjustment, 12mm rod mount. For use with 18mm sensors. Available in all 304 stainless steel or with an aluminum head and a stainless steel mounting plate.

Accessories for 18mm Sensors						
Part Number	Price	Description	Mounting Head	Mounting Plate	Drawing Link	Weight lb [g]
OPT2116	\$11.50	Wenglor mounting bracket, right-angle swivel, 360 degree vertical and horizontal adjustment, aluminum, 12mm rod mount. For use with 18mm sensors.	Aluminum	304 Stainless steel	PDF	0.15 [68.0]
OPT2117	\$21.00	Wenglor mounting bracket, right-angle swivel, 360 degree vertical and horizontal adjustment, 304 stainless steel, 12mm rod mount. For use with 18mm sensors.	304 Stainless steel	304 Stainless steel	PDF	0.28 [127.0]



[OPT2116](#), [OPT2117](#)

Note: 304 Stainless steel mounting rods sold separately: [OPT2109](#) (200mm [7.87 in] length), [OPT2110](#) (300mm [11.81 in] length), and [OPT2111](#) (500mm [19.69 in] length).

Mounting Rods and Brackets

Mounting Rods

304 Stainless steel rods for mounting swivel brackets [OPT2112](#) - [OPT2127](#). Available in three lengths: 200mm, 300mm, and 500mm. 12mm diameter.

Mounting Rods for OPT2112-2127 Swivel Mounting Brackets				
Part Number	Price	Description	Drawing Link	Weight lb (g)
OPT2109	\$13.00	Wenglor mounting rod, 12mm diameter, 200mm length, 304 stainless steel.	PDF	0.41 [185.97]
OPT2110	\$16.00	Wenglor mounting rod, 12mm diameter, 300mm length, 304 stainless steel.	PDF	0.60 [272.16]
OPT2111	\$21.00	Wenglor mounting rod, 12mm diameter, 500mm length, 304 stainless steel.	PDF	0.98 [444.52]



Right-angle Mounting Bracket

Mounting bracket, right-angle, nickel-plated brass. For use with 12mm mounting rods [OPT2109](#), [OPT2110](#) & [OPT2111](#).

Right-angle Mounting Brackets for 12mm Sensors				
Part Number	Price	Description	Drawing Link	Weight lb [g]
OPT2108	\$16.00	Wenglor mounting bracket, right-angle, nickel-plated brass. For use with 12mm mounting rods OPT2109 , OPT2110 & OPT2111 .	PDF	0.07 [31.8]

