

# HE Series Photoelectric Sensors

## M8 (8mm) Through-beam Features



M8 miniaturized HEE and HER series through-beam sensors are available with NPN or PNP, and N.O. or N.C. outputs.

In the PNP models, the load is connected between the output (black wire) and the negative (blue wire).

In the NPN models, the load is connected between the output (black wire) and the positive (brown wire).

In the Normally Open models, the output is ON when the target is present (beam interrupted); in the Normally Closed models, the output is On when the target is absent (beam free).

- M8 small dimension housing
- LED status indicator for all models
- Complete protection against electrical damage
- IP67 protection
- Strong stainless steel housing
- Fast switching frequency 10 kHz
- Sensing distance: 1 meter
- Supply voltage: 10 - 30 VDC
- NPN or PNP, N.O. or N.C. models



HE Series Through-beam Photoelectric Sensors Selection Chart									
Part Number	Price	Voltage Range	Sensing Range	Switching Frequency	Sensing Beam	Through-Beam Component	Output Type	Connection Type	Wiring
<a href="#">HEE-00-3A</a>	\$38.50	10 to 30 VDC	3.28 ft [1m]	10 kHz	Infrared	Emitter	-	1 meter cable	Diagram 3
<a href="#">HER-AP-3A</a>	\$55.00					Receiver	PNP N.O.		Diagram 2
<a href="#">HER-CP-3A</a>	\$60.00					Receiver	PNP N.C.		Diagram 2
<a href="#">HER-AN-3A</a>	Retired					Receiver	NPN N.O.		Diagram 1
<a href="#">HER-CN-3A</a>	Retired					Receiver	NPN N.C.		Diagram 1
<a href="#">HEE-00-3F</a>	\$39.50					Emitter	-		M8 quick-disconnect (purchase separately)
<a href="#">HER-AP-3F</a>	\$58.00					Receiver	PNP N.O.	Diagram 2	
<a href="#">HER-CP-3F</a>	\$60.00					Receiver	PNP N.C.	Diagram 2	
<a href="#">HER-AN-3F</a>	\$58.00					Receiver	NPN N.O.	Diagram 1	
<a href="#">HER-CN-3F</a>	\$60.00					Receiver	NPN N.C.	Diagram 1	

## Wiring Diagrams

**Diagram 1**  
NPN output

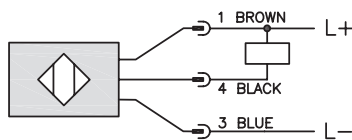

**Diagram 2**  
PNP output

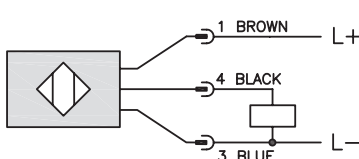

**Diagram 3**  
Emitter

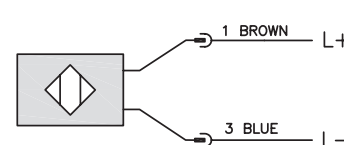

**Connector**  
M8 Connector

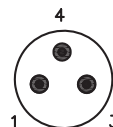

Switching Element Function		
	Through-beam and Reflective Models	Diffuse Reflective Models
Light-on	N.C.	N.O.
Dark-on	N.O.	N.C.

**Warning:** These products are not safety sensors and are not suitable for use in personal safety applications.

# HE Series Photoelectric Sensors

HEE/HER Series Photoelectric Sensors Specifications	
Type	Through-Beam
Sensing Distance	1m [3.28 ft] /Ex. Gain = 2
Light Spot Diameter	See chart
Emission	Infrared
Sensitivity	Fixed
Output Types	PNP/NPN N.O./N.C.
Operating Voltage	10 - 30 VDC
No Load Supply Current	25mA
Operating (Load) Current	100mA
Off-state (Leakage) Current (max)	<10 $\mu$ A @ 30VDC
Voltage Drop	1 Volt
Switching Frequency	10 kHz
Ripple	<10%
Time Delay Before Availability (tv)	100ms
Short-circuit Protection	Yes
Operating Temperature	-13 to 122°F [-25 to 50°C]
Protection Degree	IP67
LED Indicators - Switching Status	Yellow Output State
Housing Material	Stainless Steel
Lens Material	Polymethyl methacrylate (PMMA)
Shock/Vibration	<a href="#">See terminology section</a>
Tightening Torque	5 N•m [3.69 lb-ft]
Weight	30.9 g [1.09 oz]
Connectors	1 meter cable; 8mm quick-disconnect
Agency Approvals	CE

## Characteristic curves chart

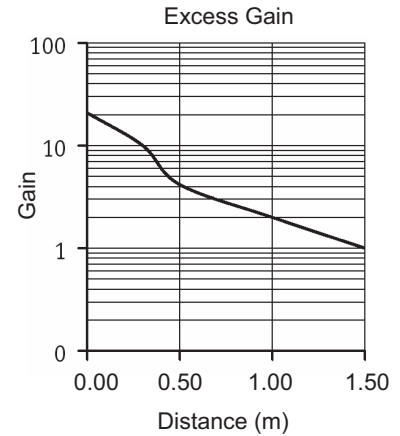

## Dimensions

(mm)

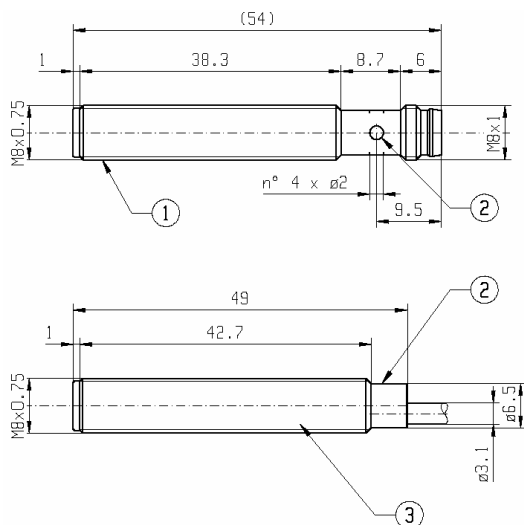

- ① M8 x 0.75 threaded cylindrical housing M8 connector exit
- ② Yellow LED (output state indicator HER - Supply Indicator HEE)
- ③ M8 x 0.75 threaded cylindrical housing cable exit

## Spot dimension chart

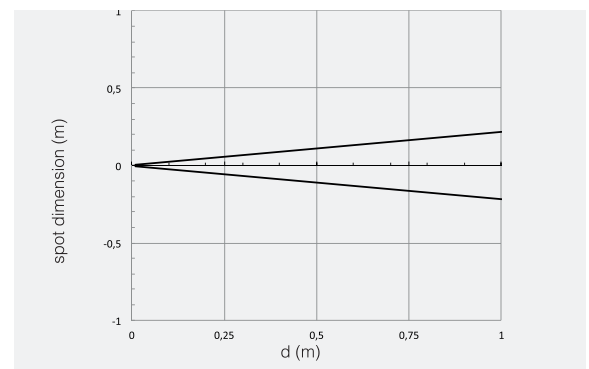

**Warning:** These products are not safety sensors and are not suitable for use in personal safety applications.

# Accessories for 8mm Sensors

## Axial Mounting Bracket

Mounting bracket, axial, zinc-plated steel. For use with 8mm sensors. Has two mounting holes (use 3 mm screws) and allows the rotation of an optical axis for axial sensors. Hexagonal nuts not included.

Accessories for 8mm Sensors				
Part Number	Price	Description	Drawing Link	Weight [lb]
<a href="#">ST08A</a>	\$2.00	Micro Detectors mounting bracket, axial, zinc plated steel. For use with 8mm sensors.	<a href="#">PDF</a>	0.04



[ST08A](#)

## Right-angle Mounting Bracket

Mounting bracket, right-angle, zinc-plated steel. For use with 8mm sensors. Has two mounting holes (use 3mm screws) and allows the rotation of an optical axis for right-beam-angle-adaptor sensors. Hexagonal nuts not included.

Accessories for 8mm Sensors				
Part Number	Price	Description	Drawing Link	Weight [lb]
<a href="#">ST08C</a>	\$2.00	Micro Detectors mounting bracket, right-angle, zinc plated steel. For use with 8mm sensors.	<a href="#">PDF</a>	0.04



[ST08C](#)

# Accessories for 8mm Sensors

## Right-angle Mounting Bracket

Mounting bracket, right-angle, plastic. For use with 8mm sensors.

Accessories for 8mm Sensors				
Part Number	Price	Description	Drawing Link	Weight [lb]
<a href="#">OPT2101</a>	\$8.00	Wenglor mounting bracket, right-angle, plastic. For use with 8mm sensors.	<a href="#">PDF</a>	0.02



[OPT2101](#)

## Right-angle Swivel Mounting Systems

Mounting bracket, right-angle swivel, 360 degree vertical and horizontal adjustment. For use with 8mm sensors. Available in all stainless steel or with an aluminum head and stainless steel mounting plate.

Accessories for 8mm Sensors						
Part Number	Price	Description	Mounting Head	Mounting Plate	Drawing Link	Weight [lb]
<a href="#">OPT2112</a>	\$11.50	Wenglor mounting bracket, right-angle swivel, 360 degree vertical and horizontal adjustment, aluminum, 12mm rod mount. For use with 8mm sensors.	Aluminum	304 Stainless Steel	<a href="#">PDF</a>	0.14
<a href="#">OPT2113</a>	\$21.00	Wenglor mounting bracket, right-angle swivel, 360 degree vertical and horizontal adjustment, 304 stainless steel, 12mm rod mount. For use with 8mm sensors.	304 Stainless Steel	304 Stainless Steel	<a href="#">PDF</a>	0.26



[OPT2112 & OPT2113](#)

Note: 304 Stainless steel mounting rods sold separately: [OPT2109](#) (200mm length), [OPT2110](#) (300mm length), and [OPT2111](#) (500mm length).

# Mounting Rods and Brackets

## Mounting Rods

304 Stainless steel rods for mounting swivel brackets [OPT2112](#) - [OPT2127](#). Available in three lengths: 200mm, 300mm, and 500mm. 12mm diameter.

Mounting Rods for OPT2112-2127 Swivel Mounting Brackets				
Part Number	Price	Description	Drawing Link	Weight lb (g)
<a href="#">OPT2109</a>	\$13.00	Wenglor mounting rod, 12mm diameter, 200mm length, 304 stainless steel.	<a href="#">PDF</a>	0.41 [185.97]
<a href="#">OPT2110</a>	\$16.00	Wenglor mounting rod, 12mm diameter, 300mm length, 304 stainless steel.	<a href="#">PDF</a>	0.60 [272.16]
<a href="#">OPT2111</a>	\$21.00	Wenglor mounting rod, 12mm diameter, 500mm length, 304 stainless steel.	<a href="#">PDF</a>	0.98 [444.52]



## Right-angle Mounting Bracket

Mounting bracket, right-angle, nickel-plated brass. For use with 12mm mounting rods [OPT2109](#), [OPT2110](#) & [OPT2111](#).

Right-angle Mounting Brackets for 12mm Sensors				
Part Number	Price	Description	Drawing Link	Weight lb [g]
<a href="#">OPT2108</a>	\$16.00	Wenglor mounting bracket, right-angle, nickel-plated brass. For use with 12mm mounting rods <a href="#">OPT2109</a> , <a href="#">OPT2110</a> & <a href="#">OPT2111</a> .	<a href="#">PDF</a>	0.07 [31.8]

