

FA Series Laser Photoelectric Sensors

M18 (18mm) metal or plastic - DC

- Diffuse, diffuse with background suppression, polarized reflective, and through-beam models
- Plastic or metal (diffuse with background suppression) housing
- Axial or right-angle optical head models
- Axial cable or M12 quick-disconnect models
- NPN or PNP, complementary N.O./N.C. outputs
- IP67 rated



FA Series Photoelectric Sensors Selection Chart											
Part Number		Price	Maximum Sensing Range	Output State	Logic	Connection	Wiring	Dimensions	Characteristic Curves		
Diffuse with Background Suppression Class 1 Laser											
FALS-BN-1E	Axial	\$111.00	100mm [3.94 in]	Complementary N.O./N.C.	NPN	M12 [12mm] connector	Diagram 1	Figure 2	Chart 4		
FALS-BP-1E		\$111.00			PNP		Diagram 2	Figure 2	Chart 4		
FALS-BN-3E	Right angle	\$120.00	80mm [3.15 in]		NPN		Diagram 1	Figure 4	Chart 5		
FALS-BP-3E		\$120.00			PNP		Diagram 2	Figure 4	Chart 5		
Diffuse with Background Suppression Class 2 Laser											
FALW-BN-1E	Axial	\$111.00	150mm [5.91 in]	Complementary N.O./N.C.	NPN	M12 [12mm] connector	Diagram 1	Figure 2	Chart 6		
FALW-BP-1E		\$111.00			PNP		Diagram 2	Figure 2	Chart 6		
FALW-BN-3E	Right angle	\$120.00	130mm [5.12 in]		NPN		Diagram 1	Figure 4	Chart 7		
FALW-BP-3E		\$120.00			PNP		Diagram 2	Figure 4	Chart 7		
Diffuse											
FAL4-BN-0A	Axial	\$133.00	300mm [11.81 in]	Complementary N.O./N.C.	NPN	2m [6.5 ft] axial cable	Diagram 1	Figure 1	Chart 1		
FAL4-BP-0A		\$133.00			PNP	2m [6.5 ft] axial cable	Diagram 2	Figure 1	Chart 1		
FAL4-BN-0E		\$133.00			NPN	M12 [12mm] connector	Diagram 1	Figure 3	Chart 1		
FAL4-BP-0E		\$133.00			PNP	M12 [12mm] connector	Diagram 2	Figure 3	Chart 1		
Polarized reflective* Class 1 Laser											
FALN-BN-0A	Axial	\$133.00	20m [65.61 ft] with RL110	Complementary N.O./N.C.	NPN	2m [6.5 ft] axial cable	Diagram 1	Figure 1	Chart 2		
FALN-BP-0A		\$133.00			PNP	2m [6.5 ft] axial cable	Diagram 2	Figure 1	Chart 2		
FALN-BN-0E		\$133.00	30m [98.43 ft] with RL201		NPN	M12 [12mm] connector	Diagram 1	Figure 3	Chart 2		
FALN-BP-0E					PNP	M12 [12mm] connector	Diagram 2	Figure 3	Chart 2		
Through-beam** Class 1 Laser											
FALD-BN-0A	Receiver	\$46.50	50m [164.04 ft]	Complementary N.O./N.C.	NPN	2m [6.5 ft] axial cable	Diagram 1	Figure 1	Chart 3		
FALD-BP-0A	Receiver				PNP	2m [6.5 ft] axial cable	Diagram 2	Figure 1	Chart 3		
FALD-BN-0E	Receiver				NPN	M12 [12mm] connector	Diagram 1	Figure 3	Chart 3		
FALD-BP-0E	Receiver				PNP	M12 [12mm] connector	Diagram 2	Figure 3	Chart 3		
FALH-X0-0A	Emitter				\$93.00	Receiver dependent		2m [6.5 ft] axial cable	Diagram 3	Figure 1	Chart 3
FALH-X0-0E	Emitter				\$93.00			M12 [12mm] connector	Diagram 3	Figure 3	Chart 3

*Purchase reflectors separately.

**Purchase one receiver and one emitter for a complete set.

FA Series Laser Photoelectric Sensors

Wiring Diagrams

Diagram 1
NPN Output

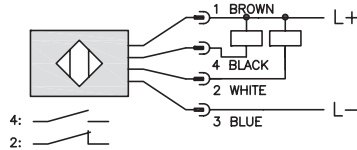

Diagram 2
PNP Output

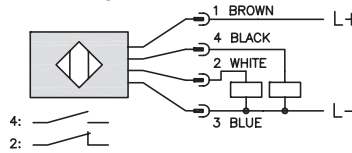
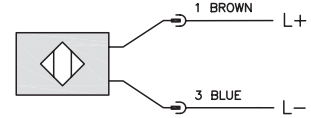

Diagram 3

Emitter with check



Cable Assembly Wiring Colors:

Pin 1 - Brown

Pin 2 - White

Pin 3 - Blue

Pin 4 - Black

Note: Wiring colors are based on Automation Direct 4-pole cable assemblies.

Switching Element Function		
	Through-Beam and Reflective Models	Diffuse Models
Light-on	N.C.	N.O.
Dark-on	N.O.	N.C.

2-meter Axial Cable version: check is black
M12 Connector: check is Pin 2 (white).

Check input: This condition simulates the presence of a target within the detection range and forces the receiver output to switch. If switching does not occur, it indicates a fault in the system.

M12 connector

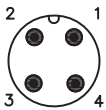

Note: N.O. = Signal ON when receiver is NOT sensing emitter.
N.C. = Signal ON when receiver is sensing emitter.

Dimensions

mm [inches]

Figure 1

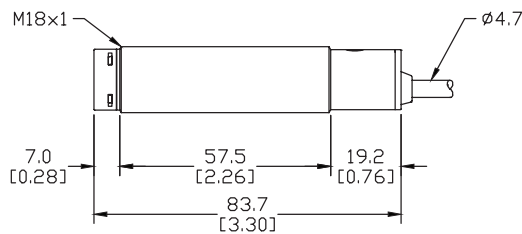

Figure 2

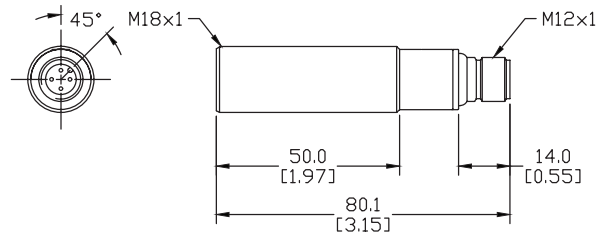

Figure 3

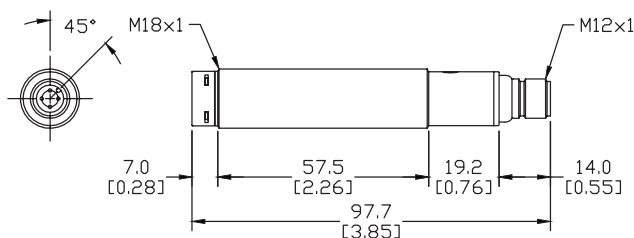
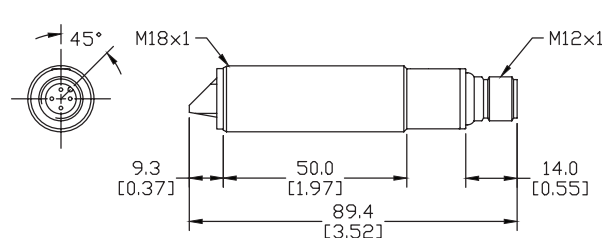

Figure 4



FA Series Laser Photoelectric Sensors

FA Series Photoelectric Sensors Specifications				
Specifications	Diffuse with Background Suppression	Diffuse Models	Reflective Models	Through-Beam Models
Type	Diffuse with background suppression	Diffuse reflection	Polarized reflection ³	Through-beam ⁴
Sensing Distance	100mm ⁵ 80mm ⁵ 150mm ⁵ 130mm ⁵	300mm ¹	20m with RL110 reflector ² 30m with RL201 reflector	50m
Light Spot Diameter	1mm @ 100mm		15mm @ 800mm	22x5 mm @ 20m
Emission	Visible red Class 1 or Class 2 Laser (650nm); see note below			
Sensitivity	Adjustable			
Output Type	NPN or PNP - Complementary N.O./N.C.			
Operating Voltage	10-30 VDC			
No-load Supply Current	≤ 40mA	≤ 30mA	≤ 20mA	≤ 25mA
Operating (Load) Current	≤ 100mA			
Off-state (Leakage) Current	≤ 10µA			
Voltage Drop	2V max at 100mA			
Switching Frequency	1.5 kHz	800Hz		1kHz
Ripple	≤ 10%			
Time Delay Before Availability (tv)	250ms	200ms		
Short-Circuit Protection	Yes, switch auto-resets after load is removed			
Operating Temperature	-10 to 50°C [14 to 122°F]	-15 to 55°C [5 to 131°F]		
Protection Degree (DIN 40050)	IEC IP67			
LED Indicators/Switch Status	Yellow (output energized) Green (power ON)			Receiver: Yellow (output energized) Emitter: Green (power ON)
Housing Material	Nickel-plated brass (metallic)	Polybutylene Terephthalate (PBT)		
Lens Material	Polycarbonate (PC)			
Shock/Vibration	See terminology Section			
Tightening Torque	25 N•m [18.44 lb-ft]	1 N•m [0.737 lb-ft]		
Weight	65g [2.29 oz]	100g [3.54 oz]		
Connectors	2m [6.5 ft] axial cable; M12 [12mm] connector. Two lock nuts included.			
Agency Approvals	cULus E187310, CE			

¹ With 100x100mm white matte paper

² With standard Ø84mm RL110 reflector

³ Purchase reflector separately.

⁴ An emitter (FALH) and receiver (FALD) pair must be ordered for a complete sensor set.

⁵ Dependent on Axial and Right Angle and Laser class.

To obtain the most current agency approval information, see the Agency Approval Checklist section on the specific part number's web page.

IMPORTANT NOTE

The Laser Classification Systems for the standards IEC (EN) 60825-1 defines the following safety classes:

Class 1

This class is eye-safe under all operating conditions.

Class 2

These are visible lasers. This class is safe for accidental viewing under all operating conditions. However, it may not be safe for a person who deliberately stares into the laser beam for longer than 0.25 s, by overcoming their natural aversion response to the very bright light.

FA Series Laser Photoelectric Sensors

Characteristic curves

Chart 1 (Diffuse)

FAL4-B*-0* Excess gain

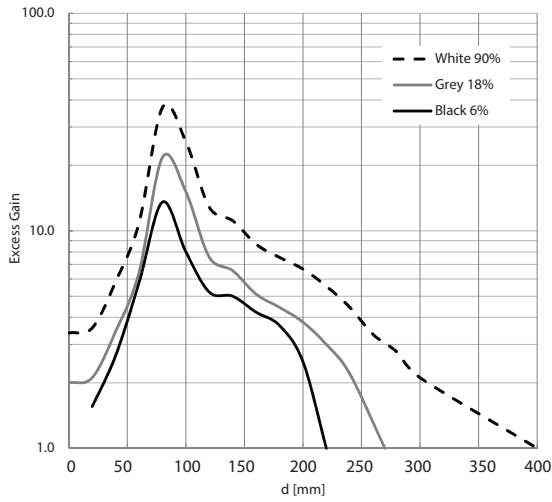
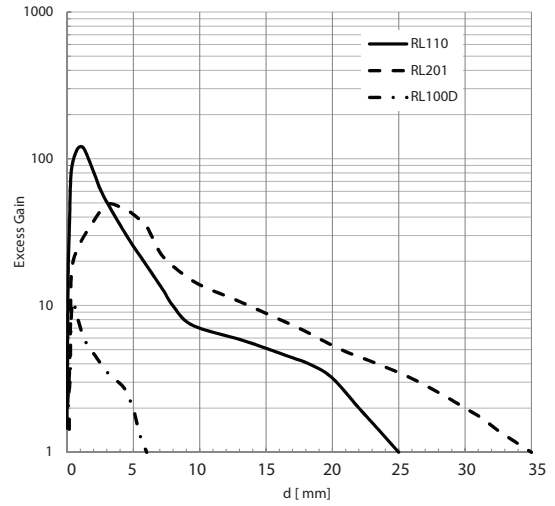
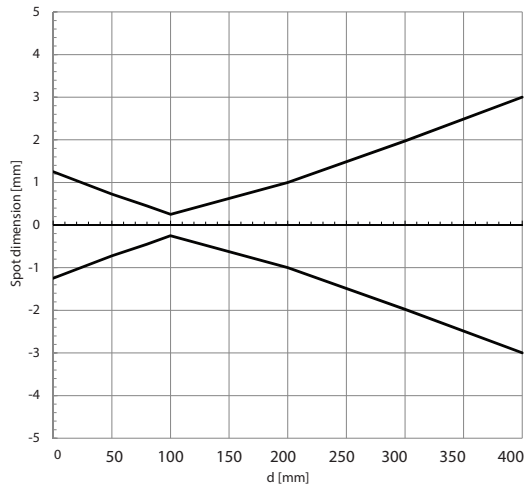

Chart 2 (Polarized Reflective)

FALN-**-** Excess gain



FAL4-B*-0* Spot dimension



FALN-**-** Spot dimension

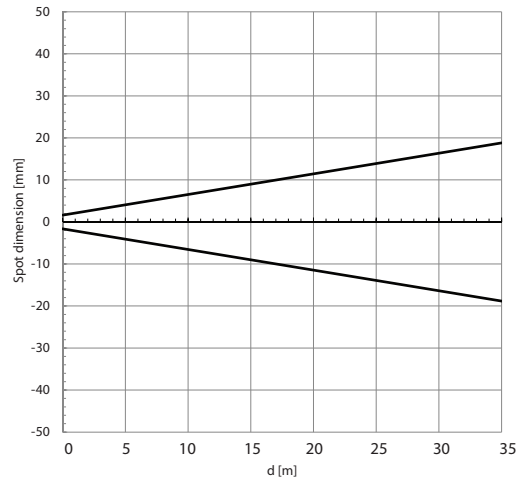

FAL4-B*-0* Parallel displacement

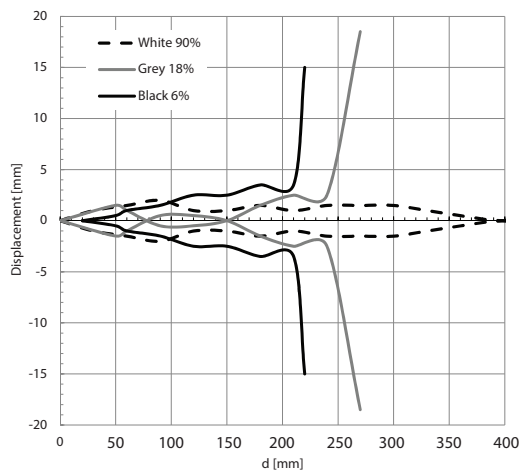

FALN-**-** Parallel displacement

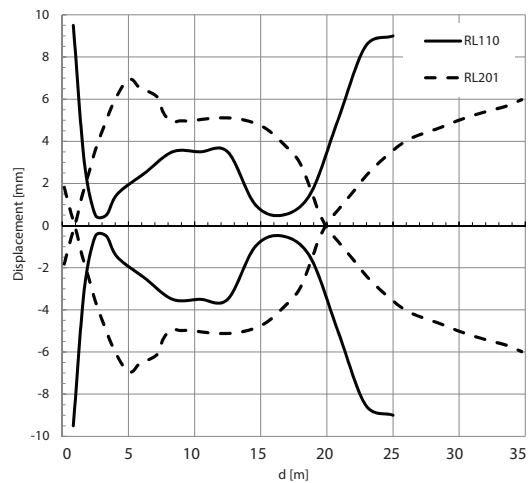

FA Series Laser Photoelectric Sensors

Chart 3 (Through-Beam)

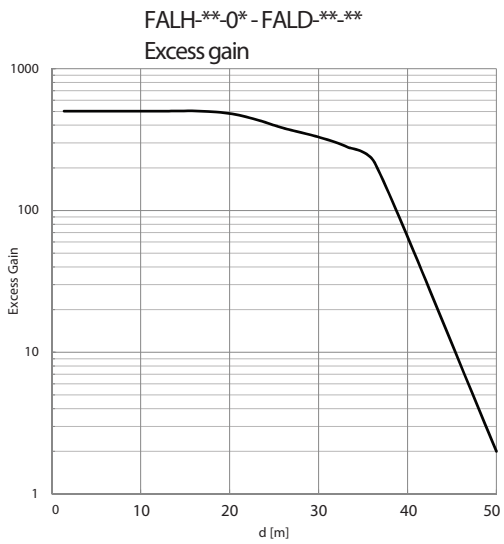

Chart 4 (Diffuse with Background Suppression Class 1)

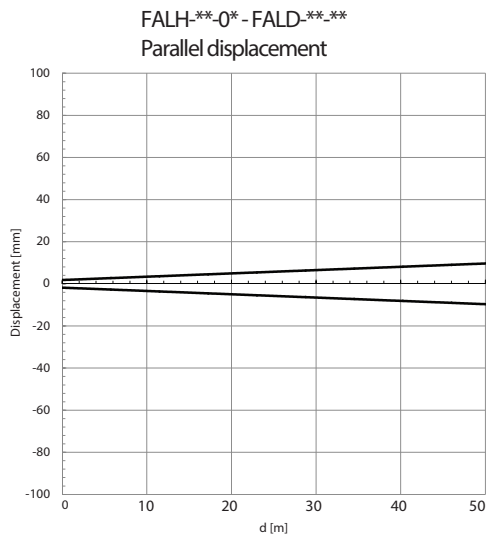
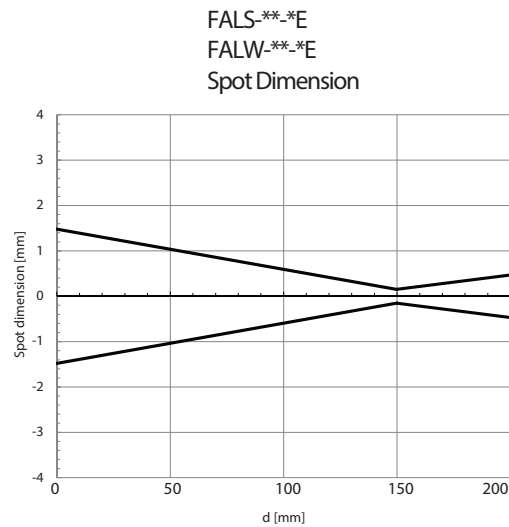
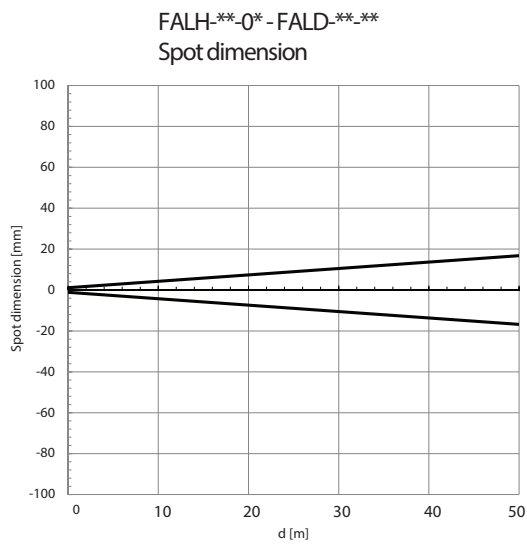
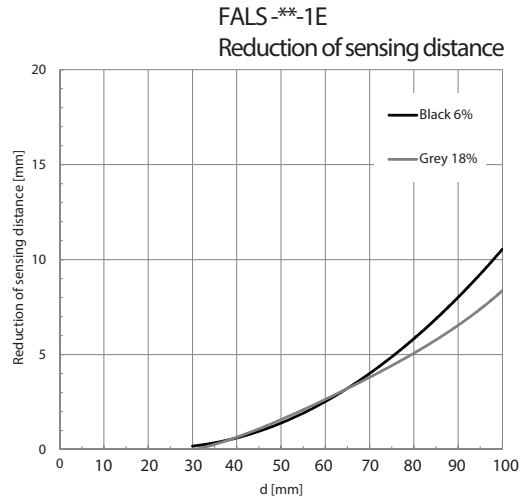
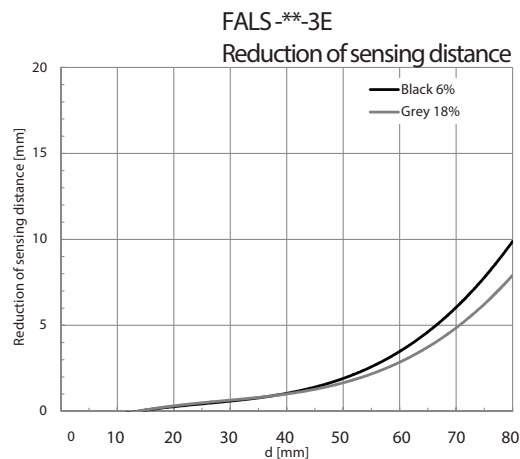

Chart 5 (Diffuse with Background Suppression Class 1)



FA Series Laser Photoelectric Sensors

Chart 6 (Diffuse with Background Suppression Class 2)

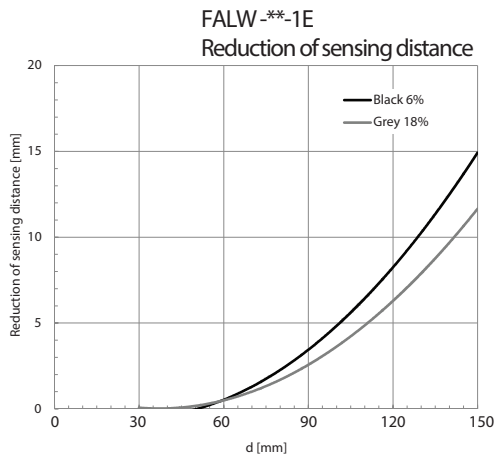
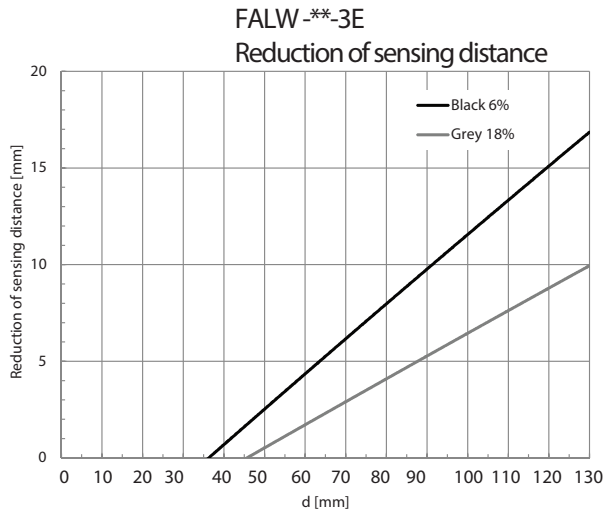

Chart 7 (Diffuse with Background Suppression Class 2)



Accessories for 18mm Sensors

Axial Mounting Bracket

Axial mounting bracket available in zinc plated steel or 316L stainless steel. Has two mounting holes (use 4mm screws) and allows for rotation of an optical axis for right-beam-angle-adaptor sensors. Hexagonal nuts not included. For use with 18mm sensors.



ST18A

Accessories for 18mm Sensors			
Part Number	Price	Description	Weight lb [g]
ST18A	\$2.00	Micro Detectors mounting bracket, axial, zinc plated steel. For use with 18mm sensors.	0.06 [27.2]
ST18A7W	\$7.25	Micro Detectors mounting bracket, axial, 316L stainless steel. For use with 18mm sensors.	0.06 [27.2]

Dimensions

mm [inches]

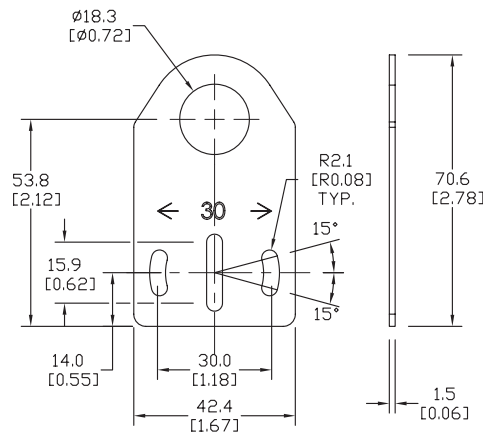

Right-angle Mounting Bracket

Right-angle mounting bracket for use with 18mm sensors. Has two mounting holes (use 4mm screws) and allows the rotation of an optical axis for axial sensors. Hexagonal nuts not included.



ST18C

Accessories for 18mm Sensors			
Part Number	Price	Description	Weight lb [g]
ST18C	\$2.00	Micro Detectors mounting bracket, right-angle, zinc plated steel. For use with 18mm sensors.	0.06 [27.2]
ST18C7W	\$7.25	Micro Detectors mounting bracket, right-angle, 316L stainless steel. For use with 18mm sensors.	0.06 [27.2]

Dimensions

mm [inches]

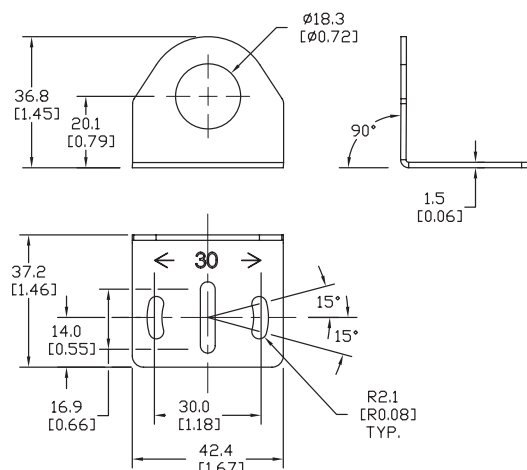

Accessories for 18mm Sensors

Right-angle Fine Tune Mounting Bracket

Mounting bracket, right-angle, fine tune vertical and horizontal adjustment, nickel-plated steel. For use with 18mm sensors. Allows for fine tuning vertical and horizontal placement.

Accessories for 18mm Sensors				
Part Number	Price	Description	Drawing Link	Weight [lb]
OPT2036	\$38.50	Wenglor mounting bracket, right-angle, fine tune vertical and horizontal adjustment, nickel plated steel. For use with 18mm sensors.	PDF	0.02

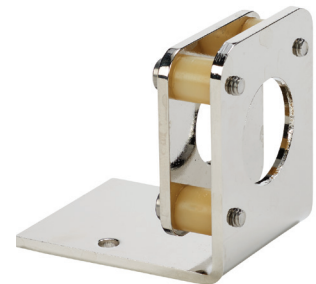

OPT2036

Swivel Mounting Bracket

Mounting bracket, ball swivel, plastic. For use with 18mm sensors. Has a ball-joint and set screws to adjust sensor orientation. Allows angular orientation up to 15 degrees (from center) in all directions for photoelectric sensors (Will not work with C18 series).

Accessories for 18mm Sensors			
Part Number	Price	Description	Weight [lb]
ST02	\$9.50	Micro Detectors mounting bracket, ball swivel, plastic. For use with 18mm sensors.	0.06

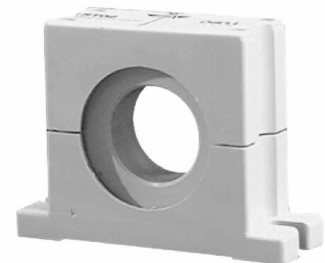

ST02

Dimensions

mm [inches]

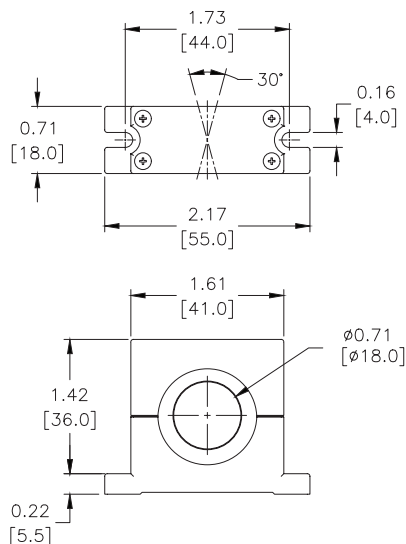

Accessories for 18mm Sensors

Right-angle Mounting Brackets

Mounting bracket, right-angle, fixed insertion stop adjustment, plastic. For use with 18mm sensors. Available with or without fixed insertion stop.

Accessories for 18mm Sensors				
Part Number	Price	Description	Drawing Link	Weight lb [g]
OPT2104	\$10.50	Wenglor mounting bracket, right-angle, fixed insertion stop adjustment, plastic. For use with 18mm sensors.	PDF	0.06 [27.2]
OPT2105	\$10.50	Wenglor mounting bracket, right-angle, plastic. For use with 18mm sensors.	PDF	0.06 [27.2]



[OPT2104](#), [OPT2105](#)

Right-angle Swivel Mounting Systems

Mounting bracket, right-angle swivel, 360 degree vertical and horizontal adjustment, 12mm rod mount. For use with 18mm sensors. Available in all 304 stainless steel or with an aluminum head and a stainless steel mounting plate.

Accessories for 18mm Sensors						
Part Number	Price	Description	Mounting Head	Mounting Plate	Drawing Link	Weight lb [g]
OPT2116	\$11.50	Wenglor mounting bracket, right-angle swivel, 360 degree vertical and horizontal adjustment, aluminum, 12mm rod mount. For use with 18mm sensors.	Aluminum	304 Stainless steel	PDF	0.15 [68.0]
OPT2117	\$21.00	Wenglor mounting bracket, right-angle swivel, 360 degree vertical and horizontal adjustment, 304 stainless steel, 12mm rod mount. For use with 18mm sensors.	304 Stainless steel	304 Stainless steel	PDF	0.28 [127.0]



[OPT2116](#), [OPT2117](#)

Note: 304 Stainless steel mounting rods sold separately: [OPT2109](#) (200mm [7.87 in] length), [OPT2110](#) (300mm [11.81 in] length), and [OPT2111](#) (500mm [19.69 in] length).

Mounting Rods and Brackets

Mounting Rods

304 Stainless steel rods for mounting swivel brackets [OPT2112](#) - [OPT2127](#). Available in three lengths: 200mm, 300mm, and 500mm. 12mm diameter.

Mounting Rods for OPT2112-2127 Swivel Mounting Brackets				
Part Number	Price	Description	Drawing Link	Weight lb (g)
OPT2109	\$13.00	Wenglor mounting rod, 12mm diameter, 200mm length, 304 stainless steel.	PDF	0.41 [185.97]
OPT2110	\$16.00	Wenglor mounting rod, 12mm diameter, 300mm length, 304 stainless steel.	PDF	0.60 [272.16]
OPT2111	\$21.00	Wenglor mounting rod, 12mm diameter, 500mm length, 304 stainless steel.	PDF	0.98 [444.52]



Right-angle Mounting Bracket

Mounting bracket, right-angle, nickel-plated brass. For use with 12mm mounting rods [OPT2109](#), [OPT2110](#) & [OPT2111](#).

Right-angle Mounting Brackets for 12mm Sensors				
Part Number	Price	Description	Drawing Link	Weight lb [g]
OPT2108	\$16.00	Wenglor mounting bracket, right-angle, nickel-plated brass. For use with 12mm mounting rods OPT2109 , OPT2110 & OPT2111 .	PDF	0.07 [31.8]



Reflectors

RL Series Reflectors for Polarized Reflective Photoelectric Sensors (All Models)

- Suitable for use with polarized light photoelectric sensors
- Shapes and sizes for most applications
- Miniature types for close mounting in multiple sensor installations
- Single hole, dual hole and self-adhesive mounting types available
- Single and 10-packs available

Installation Notes

- Keep the reflector surface clean to ensure peak detection performance. This is especially true when the maximum sensing range is being used. Clean using a damp cloth.
- When selecting a reflector, it is important to consider the ambient conditions it will be exposed to. Dusty or high humidity conditions may reduce the sensing range as much as 90%.
- Reflectors should be positioned at a 90° angle to the optical axis with a tolerance of ±15°.

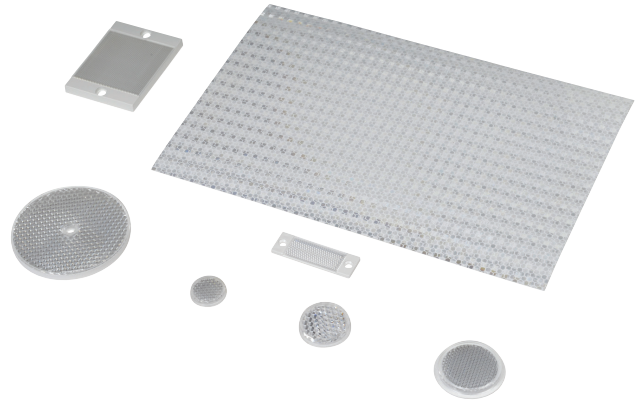

Reflector Specifications								
Part number	Price	Drawing Link	Quantity	Dimensions mm [in]	Degree of Protection	Mounting	Materials	
RL102	\$38.00	PDF	10	25	IEC IP67	Customer-supplied adhesive or other mounting method required	Reflective face: PMMA Polymethylmethacrylate (acrylic) Base material: ABS (Acrylonitrile-butadiene-styren)	
RL102-1	\$4.25		1	[0.98]				
RL103	\$42.50	PDF	10	34.5				
RL103-1	\$4.75		1	[1.36]				
RL104	\$42.50	PDF	10	46				Two 4.3 mm holes
RL104-1	\$4.75		1	[1.81]				
RL105G	\$38.00	PDF	10	95 x 38		Two 6mm holes		
RL105G-1	\$4.25		1	[3.74 x 1.50]				
RL106G	\$42.50	PDF	10	182 x 42		One 5mm hole		
RL106G-1	\$4.75		1	[7.17 x 1.65]				
RL110	\$19.00	PDF	10	84		Two 3mm holes		
RL110-1	\$2.00		1	[3.31]				
RL116	\$19.00	PDF	10	41 x 60		Self-adhesive		Paper (Acrylic tape with micro prism)
RL116-1	\$2.00		1	[3.54 x 2.36]				
RL100DA4	\$38.50	NA	1	200 x 300				
RL100DC4	\$12.00	NA	1	50 x 300				
RL100DQ1	\$8.75	NA	1	100 x 100				
RL111G	\$60.00	PDF	10	22.5 x 47	Two 3mm slots		Reflective face: PMMA Polymethylmethacrylate (acrylic) Base material: ABS (Acrylonitrile-butadiene-styren)	
RL111G-1	\$7.25		1	[0.89 x 1.85]				
RL112G	\$44.00	PDF	10	19 x 73				
RL112G-1	\$4.75		1	[0.75 x 2.87]				
RL113G	\$53.00	PDF	10	51.4 x 60.3	Two 4mm slots			
RL113G-1	\$6.00		1	[2.02 x 2.37]				

Not recommended for applications involving moist air environments or water immersion.

Reflectors

RL Series Reflectors for Polarized Reflective Laser Photoelectric Sensors (FALN series)

- Suitable for use with polarized light laser photoelectric sensors
- Sizes for most applications
- Miniature types for close mounting in multiple sensor installations
- Single and 5-packs available

Specifications						
Part Number	RL201	RL201-1	RL203	RL203-1	RL204	RL204-1
Price	\$38.00	\$8.25	\$35.50	\$7.75	\$30.00	\$6.75
Quantity	5	1	5	1	5	1
Drawing Link	PDF		PDF		PDF	
Dimensions	60 x 82 mm 2.36 x 3.23 in		19 x 6mm 0.75 x 2.36 in		20mm x 32mm 0.80 in x 1.26 in	
Degree of Protection ¹	IEC IP67					
Mounting	Two 0.4 mm holes		Two 0.4 mm holes		Two 0.3 mm holes	
Materials	Acrylic/polycarbonate					

¹ Not recommended for applications involving moist air environments or water immersion.