

DC Input Modules

P3-64ND3 \$260.00

Sinking/Sourcing Input

The P3-64ND3 DC Input Module provides sixty-four 24 VDC sinking or sourcing inputs with eight isolated commons.

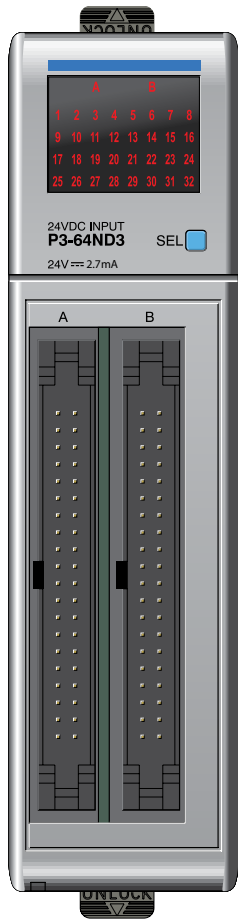

No terminal block sold for this module; ZIPLink required.

See Wiring Solutions for part numbers of ZIPLink cables and connection modules required with this I/O module.



| Input Specifications | |
|--|--------------------------------|
| Inputs per Module | 64 (sinking / sourcing) |
| Operating Voltage Range (Tolerance) | CE 24VDC ($\pm 10\%$) |
| | UL 24VDC ($\pm 10\%$) |
| Peak Voltage | 26.4 VDC |
| Input Current (Typical) | 2.7 mA @ 24VDC |
| Maximum Input Current @ Temp | 3.5 mA @ 60° C (26.4 VDC) |
| Input Impedance | 8.2 k Ω @ 24VDC |
| ON Voltage Level | > 18VDC |
| OFF Voltage Level | < 8VDC |
| Minimum ON Current | 2mA |
| Maximum OFF Current | 1.1 mA |
| OFF to ON Response | 2ms max.; typical 1ms |
| ON to OFF Response | 2ms max.; typical 1ms |
| Status Indicators | Logic Side (32 points x 2) |
| Connector Type | Two 40-pin IDC |
| Commons | 8 Isolated (8 points / common) |

| General Specifications | |
|--------------------------------------|--|
| Operating Temperature | 0°C–60°C (32°F–140°F), |
| Storage Temperature | -20°C–70°C (-4°F–158°F) |
| Humidity | 5 to 95% (non-condensing) |
| Environmental Air | No corrosive gases permitted |
| Vibration | IEC60068-2-6 (Test Fc) |
| Shock | IEC60068-2-27 (Test Ea) |
| Field to Logic Side Isolation | 1500VAC applied for 1 minute |
| Insulation Resistance | >10M Ω @ 500VDC |
| Heat Dissipation | 6.91W |
| Enclosure Type | Open equipment |
| Module Keying to Backplane | Electronic |
| Module Location | Any I/O slot in any local, expansion, or remote base in a Productivity3000 system. |
| Field Wiring | Use ZIPLink wiring system. See Wiring Solutions. |
| Weight | 170g (6.0 oz) |
| Agency Approvals | UL508 file E157382, Canada & USA UL1604 file E200031, Canada & USA CE (EN61131-2*) This equipment is suitable for use in Class 1, Division 2, Groups A, B, C and D or non-hazardous locations only. |

*Meets EMC and Safety requirements. See the Declaration of Conformity for details.

| Connector Specifications | |
|--------------------------|--|
| Connector Type | IDC style header with latch, Omron XG4A-4034 |
| Number of Pins | 40 point x 2 |
| Pitch | 0.1 in. (2.54 mm) |

WARNING: EXPLOSION HAZARD – SUBSTITUTION OF COMPONENTS MAY IMPAIR SUITABILITY FOR CLASS I, DIVISION 2.

DC Input Modules

P3-64ND3 (cont'd)

Wiring Diagrams

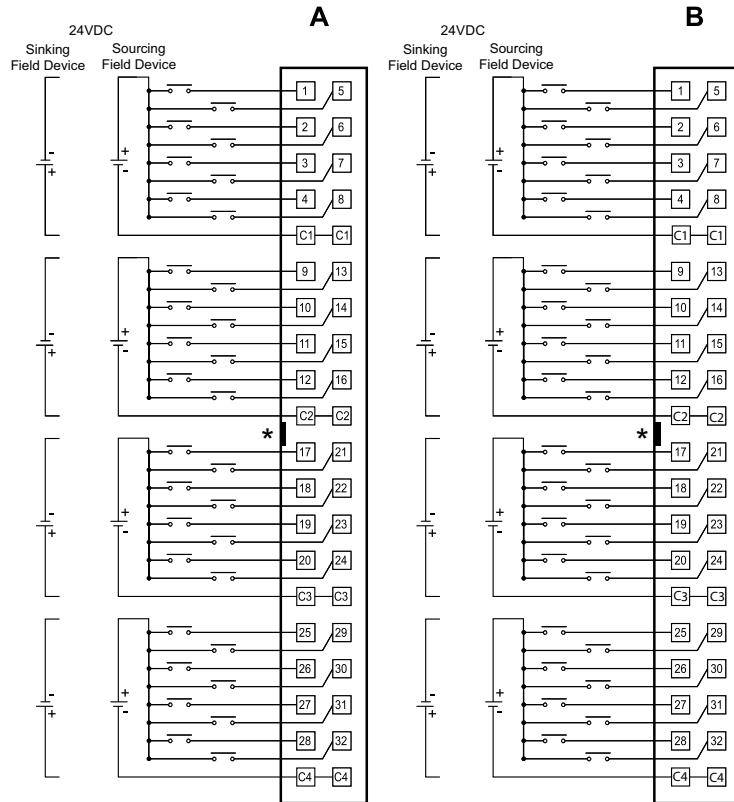

*Denotes key location of all associated ZIPLink cables

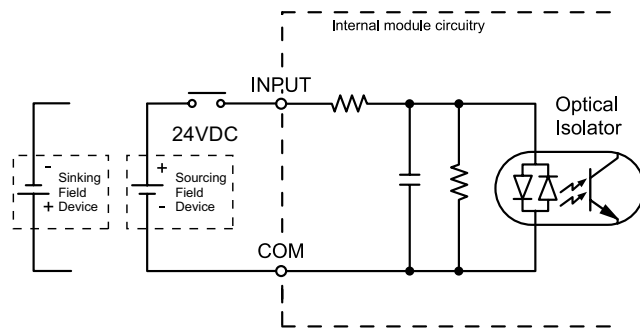



Wiring Solutions

Wiring Solutions using the ZIPLink wiring system

ZIPLinks eliminate the normally tedious process of wiring between devices by utilizing prewired cables and DIN rail mount connector modules. It's as simple as plugging in a cable connector at either end or terminating wires at only one end. Prewired cables keep installation clean and efficient, using half the space at a fraction of the cost of standard terminal blocks. There are several wiring solutions available when using the **ZIPLink** System ranging from

Solution 1: Productivity Series I/O Modules to ZIPLink Connector Modules

When looking for quick and easy I/O-to-field termination, a **ZIPLink** connector module used in conjunction with a prewired **ZIPLink** cable, consisting of an I/O terminal block at one end and a multi-pin connector at the other end, is the best solution.

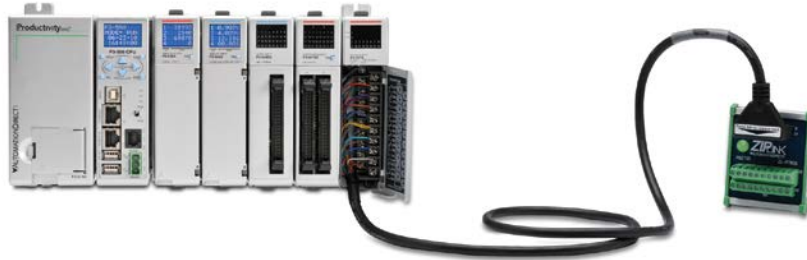

PLC I/O-to-**ZIPLink** Connector Modules that are ready for field termination, options for connecting to third party devices, GS, DuraPulse and SureServo Drives, and specialty relay, transorb and communications modules. Pre-printed I/O-specific adhesive label strips for quick marking of **ZIPLink** modules are provided with **ZIPLink** cables. See the following solutions to help determine the best **ZIPLink** system for your application.

Using the PLC I/O Modules to **ZIPLink** Connector Modules selector tables located in this section,

1. Locate your I/O module/PLC.
2. Select a **ZIPLink** Module.
3. Select a corresponding **ZIPLink** Cable.

Solution 2: Productivity Series I/O Modules to ZIPLink Connector Modules

When wanting to connect I/O to another device within close proximity of the I/O modules, no extra terminal blocks are necessary when using the **ZIPLink** Pigtail Cables. **ZIPLink** Pigtail Cables are prewired to an I/O terminal block with color-coded pigtail with soldered-tip wires on the other end.

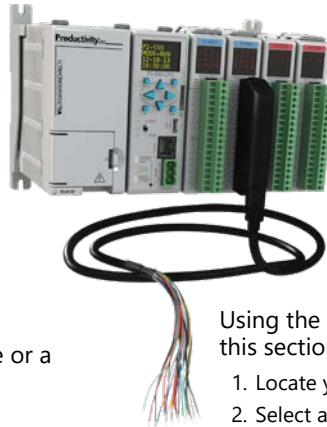

Using the I/O Modules to 3rd Party Devices selector tables located in this section,

1. Locate your PLC I/O module.
2. Select a **ZIPLink** Pigtail Cable that is compatible with your 3rd party device.

Solution 3: GS Series and DuraPulse Drives Communication Cables

Need to communicate via Modbus RTU to a drive or a network of drives?

ZIPLink cables are available in a wide range of configurations for connecting to PLCs and SureServo, SureStep, Stellar Soft Starter and AC drives. Add a **ZIPLink** communications module to quickly and easily set up a multi-device network.

Using the Drives Communication selector tables located in this section,

1. Locate your Drive and type of communications.
2. Select a **ZIPLink** cable and other associated hardware.





Wiring Solutions

Solution 4: Serial Communications Cables

ZIPLink offers communications cables for use with DirectLOGIC, CLICK, and Productivity3000 CPUs, that can also be used with other communications devices. Connections include a 6-pin RJ12 or 9-pin, 15-pin and 25-pin D-sub connectors which can be used in conjunction with the RJ12 or D-Sub Feedthrough modules.

Using the Serial Communications Cables selector table located in this section,

1. Locate your connector type
2. Select a cable.



Solution 5: Specialty ZIPLink Modules

For additional application solutions, **ZIPLink** modules are available in a variety of configurations including stand-alone relays, 24VDC and 120VAC transorb modules, D-sub and RJ12 feedthrough modules, communication port adapter and distribution modules, and SureServo 50-pin I/O interface connection.

Using the **ZIPLink** Specialty Modules selector table located in this section,

1. Locate the type of application.
2. Select a **ZIPLink** module.



Solution 6: ZIPLink Connector Modules to 3rd Party Devices

If you need a way to connect your device to terminal blocks without all that wiring time, then our pigtail cables with color-coded soldered-tip wires are a good solution. Used in conjunction with any compatible **ZIPLink** Connector Modules, a pigtail cable keeps wiring clean and easy and reduces troubleshooting time.

Using the Universal Connector Modules and Pigtail Cables table located in this section,

1. Select module type.
2. Select the number of pins.
3. Select cable.





CPU I/O Modules to ZIPLink Connector Modules - Productivity3000®

| Productivity3000 CPU Input Module ZIPLink Selector | | | | |
|--|------------|-------------|-----------------|----------------------------------|
| CPU | | ZIPLink | | |
| Input Module | # of Terms | Component | Module Part No. | Cable Part No. |
| P3-08NAS | 20 | Feedthrough | ZL-RTB20 | ZL-P3-CBL20 * |
| P3-08ND3S | 20 | Feedthrough | | |
| P3-16NA | 20 | Feedthrough | | |
| P3-16ND3 | 20 | Feedthrough | ZL-LTB16-24-1 | ZL-P3-CBL20-1L ZL-P3-CBL20-2L |
| | | Sensor | | |
| P3-32ND3 | 40 | Feedthrough | ZL-RTB40 | ZL-CBL40 ZL-CBL40-1 |
| | | Sensor | ZL-LTB32-24-1 | |
| P3-64ND31 | 40 | Feedthrough | ZL-RTB40 | ZL-CBL40-2 |
| | | Sensor | ZL-LTB32-24-1 | |

| Productivity3000 CPU Output Module ZIPLink Selector | | | | |
|---|------------|------------------|-----------------------|---|
| CPU | | ZIPLink | | |
| Output Module | # of Terms | Component | Module Part No. | Cable Part No. |
| P3-08TAS | 20 | Feedthrough | ZL-RTB20 | ZL-P3-CBL20 * |
| P3-08TD1S | 20 | Feedthrough | | |
| P3-08TD2S | 20 | Feedthrough | | |
| P3-08TRS | 20 | Feedthrough | | ZL-P3-CBL20 ZL-P3-CBL20-1L ZL-P3-CBL20-2L |
| P3-16TA | 20 | Feedthrough | | |
| | | Fuse | | |
| P3-16TD1 | 20 | Feedthrough | | |
| | | Fuse | ZL-RFU20 ⁴ | |
| | | Relay (sinking) | ZL-RRL16-24-1 | |
| P3-16TD2 | 20 | Feedthrough | ZL-RTB20 | |
| | | Fuse | ZL-RFU20 ⁴ | |
| | | Relay (sourcing) | ZL-RRL16-24-2 | |
| P3-16TR | 20 | Feedthrough | ZL-RTB20 | |
| | | Fuse | ZL-RFU20 ⁴ | |
| P3-08TRS-1 ³ | 20 | Feedthrough | ZL-RTB20 | |
| | | Fuse | ZL-RFU20 ⁴ | |
| P3-32TD1 | 40 | Feedthrough | ZL-RTB40 | ZL-CBL40 ZL-CBL40-1 ZL-CBL40-2 |
| | | Fuse | ZL-RFU40 ⁴ | |
| P3-32TD2 | 40 | Feedthrough | ZL-RTB40 | |
| | | Fuse | ZL-RFU40 ⁴ | |
| P3-64TD1 ¹ | 40 | Feedthrough | ZL-RTB40 | |
| | | Fuse | ZL-RFU40 ⁴ | |
| P3-64TD2 ¹ | 40 | Feedthrough | ZL-RTB40 | |
| | | Fuse | ZL-RFU40 ⁴ | |

| Productivity3000 CPU Analog In Module ZIPLink Selector | | | | |
|--|---------------|-------------|----------|----------------------------------|
| CPU | | ZIPLink | | |
| Analog Module | # of Terms | Component | Module | Cable |
| P3-04ADS | 20 | Feedthrough | ZL-RTB20 | ZL-P3-CBL20-1L ZL-P3-CBL20-2L |
| P3-08AD | 20 | Feedthrough | | |
| P3-16AD-1 | 20 | Feedthrough | | |
| P3-16AD-2 | 20 | Feedthrough | | |
| P3-08RTD ² | Matched Only | See Note 2 | | |
| P3-08THM ² | T/C Wire Only | See Note 2 | | |
| P3-04DA | 20 | Feedthrough | ZL-RTB20 | ZL-P3-CBL20-1L ZL-P3-CBL20-2L |
| P3-08DA-1 | 20 | Feedthrough | | |
| P3-08DA-2 | 20 | Feedthrough | | |
| P3-16DA-1 | 20 | Feedthrough | | |
| P3-16DA-2 | 20 | Feedthrough | | |
| P3-8AD4DA-1 | 20 | Feedthrough | | |
| P3-8AD4DA-2 | 20 | Feedthrough | | |

| Productivity3000 CPU Specialty Module ZIPLink Selector | | | | |
|--|------------|-------------|-----------------|----------------------------|
| CPU | | ZIPLink | | |
| Input Module | # of Terms | Component | Module Part No. | Cable Part No. |
| P3-HSI | 40 | Feedthrough | ZL-RTB40 | ZL-CBL40-S |
| P3-HSO | | | | ZL-CBL40-1S ZL-CBL40-2S |

* Select the cable length by replacing the * with: Blank = 0.5m, -1 = 1.0m, or -2 = 2.0m.

1 The P3-64ND3, P3-64TD1 and P3-64TD2 modules have two 32-point connectors and require two ZIPLink cables and two ZIPLink connector modules.

2 These modules are not supported by the ZIPLink wiring system.

3 The P3-08TRS-1 output module is derated not to exceed 2A per point maximum when used with the ZIPLink wiring system.

4 Note: Fuses (5 x 20 mm) are not included. See Edison Electronic Fuse section for (5 x 20 mm) fuse. S500 and GMA electronic circuit protection for fast-acting maximum protection. S506 and GMC electronic circuit protection for time-delay performance. Ideal for inductive circuits.

To ensure proper operation, do not exceed the voltage and current rating of ZIPLink module. ZL-RFU20 = 2A per circuit; ZL-RFU40 = 400 mA per circuit.



Note: ZIPLink Connector Modules specifications follow the Compatibility Matrix tables. ZIPLink Cables specifications are at the end of this ZIPLink section.

I/O Modules

A variety of discrete, analog and specialty I/O modules are available for use in local, expansion, and remote I/O bases. Specifications for each module are on the following pages.

A filler module is available for unused I/O module slots (part number P3-FILL).

Discrete Input Modules

| Productivity3000 Discrete Input Modules | | | |
|---|------------------|------------------------------------|----------|
| Part Number | Number of Inputs | Description | Price |
| P3-16SIM | 16 | Input Simulator Module | \$197.00 |
| P3-08ND3S | 8 | Isolated Sinking/Sourcing DC Input | \$99.00 |
| P3-16ND3 | 16 | Sinking/Sourcing DC Input | \$152.00 |
| P3-32ND3 | 32 | Sinking/Sourcing DC Input | \$208.00 |
| P3-64ND3 | 64 | Sinking/Sourcing DC Input | \$260.00 |
| P3-08NAS | 8 | Isolated AC Input | \$126.00 |
| P3-16NA | 16 | AC Input | \$159.00 |

*ZIPLink required.

Analog I/O Modules

| Productivity3000 Analog Input Modules | | | |
|---------------------------------------|--------------------|---------------------------|----------|
| Part Number | Number of Channels | Description | Price |
| P3-04ADS | 4 | Isolated Analog Input | \$724.00 |
| P3-08AD | 8 | Analog Input | \$393.00 |
| P3-16AD-1 | 16 | Analog Input (Current) | \$535.00 |
| P3-16AD-2 | 16 | Analog Input (Voltage) | \$524.00 |
| P3-08RTD | 8 | Analog RTD Input | \$581.00 |
| P3-08THM | 8 | Analog Thermocouple Input | \$736.00 |

| Productivity3000 Analog Output Modules | | | |
|--|--------------------|-------------------------|----------|
| Part Number | Number of Channels | Description | Price |
| P3-04DA | 4 | Analog Output | \$449.00 |
| P3-08DA-1 | 8 | Analog Output (Current) | \$779.00 |
| P3-08DA-2 | 8 | Analog Output (Voltage) | \$725.00 |
| P3-16DA-1 | 16 | Analog Output (Current) | \$929.00 |
| P3-16DA-2 | 16 | Analog Output (Voltage) | \$911.00 |

| Productivity3000 Analog Input/Output Modules | | | |
|--|--------------------|-------------------------------|----------|
| Part Number | Number of Channels | Description | Price |
| P3-8AD4DA-1 | 8/4 | Analog Input/Output (Current) | \$598.00 |
| P3-8AD4DA-2 | 8/4 | Analog Input/Output (Voltage) | \$617.00 |

Specialty Modules

| Productivity3000 Specialty Modules | | | |
|------------------------------------|--------------------|------------------------------|----------|
| Part Number | Number of Channels | Description | Price |
| P3-HSI | 2 | High-Speed Pulse Input | \$563.00 |
| P3-HSO* | 2 | High-Speed Output | \$587.00 |
| P3-SCM | 4 ports | Serial Communications Module | \$475.00 |

*ZIPLink required.

Discrete Output Modules

| Productivity3000 Discrete Output Modules | | | |
|--|-------------------|--------------------------|----------|
| Part Number | Number of Outputs | Description | Price |
| P3-08TD1S | 8 | Isolated Sinking Output | \$135.00 |
| P3-08TD2S | 8 | Isolated Sourcing Output | \$141.00 |
| P3-16TD1 | 16 | Sinking Output | \$162.00 |
| P3-16TD2 | 16 | Sourcing Output | \$167.00 |
| P3-32TD1* | 32 | Sinking Output | \$208.00 |
| P3-32TD2* | 32 | Sourcing Output | \$208.00 |
| P3-64TD1* | *64 | Sinking Output | \$280.00 |
| P3-64TD2* | *64 | Sourcing Output | \$265.00 |
| P3-08TAS | 8 | Isolated AC Output | \$177.00 |
| P3-16TA | 16 | AC Output | \$210.00 |
| P3-08TRS | 8 | Isolated Relay Output | \$159.00 |
| P3-08TRS-1 | 8 | Isolated Relay Output | \$194.00 |
| P3-16TR | 16 | Relay Output | \$177.00 |

*ZIPLink required.

Module Installation Procedure

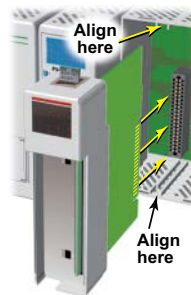

WARNING: DO NOT APPLY FIELD POWER UNTIL THE FOLLOWING STEPS ARE COMPLETED. SEE HOT-SWAPPING PROCEDURE FOR EXCEPTIONS.

Step One: Align circuit card with slot and press firmly to seat module into connector.

Step Two: Pull top and bottom locking tabs toward module face. Click indicates lock is engaged.

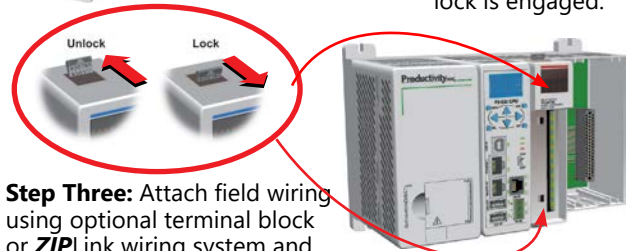

Step Three: Attach field wiring using optional terminal block or ZIPLink wiring system and install cover.

To install or remove terminal block cover, press middle to flex cover.

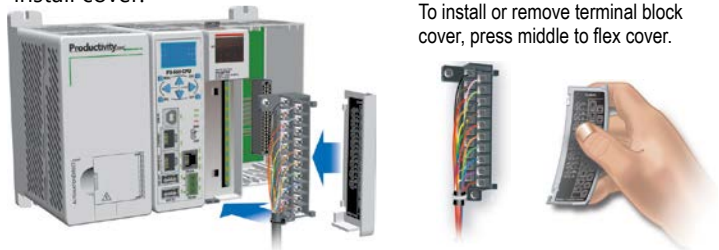

WARNING: EXPLOSION HAZARD – DO NOT CONNECT OR DISCONNECT CONNECTORS OR OPERATE SWITCHES WHILE CIRCUIT IS LIVE UNLESS THE AREA IS KNOWN TO BE NON-HAZARDOUS. DO NOT HOT-SWAP MODULES UNLESS THE AREA IS KNOWN TO BE NON-HAZARDOUS.