

Analog Input Modules

P3-16AD-2 \$524.00

Voltage Analog Input

The P3-16AD-2 Voltage Analog Input Module provides sixteen channels for receiving 0 to 10 VDC signals.

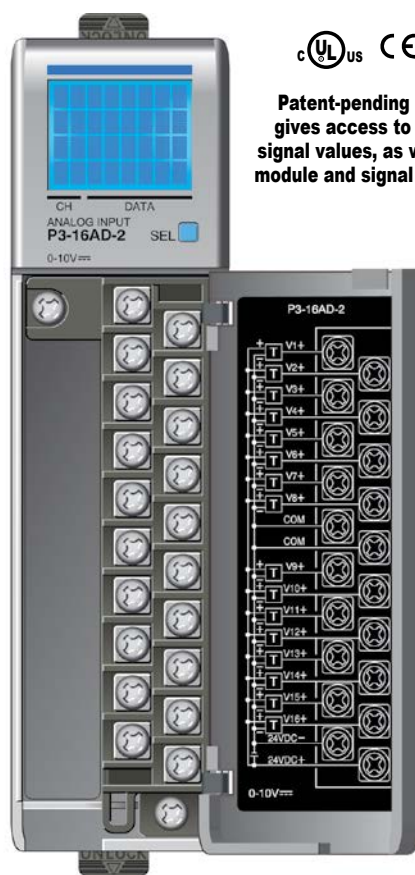

Patent-pending LCD gives access to field signal values, as well as module and signal faults.

Terminal block sold separately; terminal block cover included with module.

Removable Terminal Block Specifications	
Description	Part No. P3-RTB; 20 screw terminals
Wire Range	22–14 AWG (0.324 to 2.08 sq. mm) Solid / stranded conductor 3/64 in. (1.2 mm) insulation maximum USE COPPER CONDUCTORS, 60°C or equivalent.
Screw Driver Width	1/4 inch (6.5 mm) maximum
Screw Size	M3 size
Screw Torque	Field terminals - 7–9 in·lb (0.882–1.02 N·m) Self-jacking screws - 2.7–3.6 in·lb (0.3–0.4 N·m). Do not overtighten screws when installing terminal block.

We recommend using prewired **ZIPLink** cables and connection modules. See Wiring Solutions.

Terminal block cover included. If you wish to hand-wire your module, a removable terminal block is sold separately. Order part number P3-RTB.



Input Specifications	
Input Channels	16
Module Signal Input Range	0–10 VDC
Signal Resolution	16-bit
Resolution Value of LSB (least significant bit)	0–10 VDC = 152µV per count (1 LSB = 1 count)
Data Range	0 to 65535 counts
Input Type	Single-ended (one common)
Maximum Continuous Overload	±100V
Input Impedance	250kΩ (typical)
Filter Characteristics	Low Pass, -3dB @ 100Hz
Sample Duration Time	7ms per channel (does not include ladder scan time)
All Channel Update Rate	112ms
Open Circuit Detection Time	Zero reading within 1s
Conversion Method	Successive approximation
Accuracy vs. Temperature	±25 PPM / °C maximum
Maximum Inaccuracy	0.1% of range (including temperature drift)
Linearity Error (end to end)	±10 LSB maximum (±0.015% of range) Monotonic with no missing codes
Input Stability and Repeatability	±10 LSB
Full Scale Calibration Error (not including offset)	±10 LSB maximum (±0.015% of range)
Offset Calibration Error	±10 LSB maximum
Max Crosstalk	-76dB, 10 LSB
External DC Power Required	24VDC (-20% / + 25%), 41mA maximum

General Specifications	
Operating Temperature	0°C– 60°C (32°F–140°F),
Storage Temperature	-20°C–70°C (-4°F–158°F)
Humidity	5 to 95% (non-condensing)
Environmental Air	No corrosive gases permitted
Vibration	IEC60068-2-6 (Test Fc)
Shock	IEC60068-2-27 (Test Ea)
Field to Logic Side Isolation	1800VAC applied for 1s
Insulation Resistance	>10MΩ @ 500VDC
Heat Dissipation	1.4 W
Enclosure Type	Open equipment
Module Keying to Backplane	Electronic
Module Location	Any I/O slot in any local, expansion, or remote base in a Productivity3000 system.
Field Wiring	Removable terminal block (not included). Use ZIPLink wiring system or optional terminal block. See Wiring Solutions.
Terminal Type (not included)	20-position removable terminal block
Weight	105g (3.73 oz)
Agency Approvals	UL508 file E157382, Canada & USA UL1604 file E200031, Canada & USA CE (EN61131-2*) This equipment is suitable for use in Class 1, Division 2, Groups A, B, C and D or non-hazardous locations only.

*Meets EMC and Safety requirements. See the Declaration of Conformity for details.

WARNING: EXPLOSION HAZARD – SUBSTITUTION OF COMPONENTS MAY IMPAIR SUITABILITY FOR CLASS 1, DIVISION 2.

Analog Input Modules

P3-16AD-2 (cont'd)

Wiring Diagrams

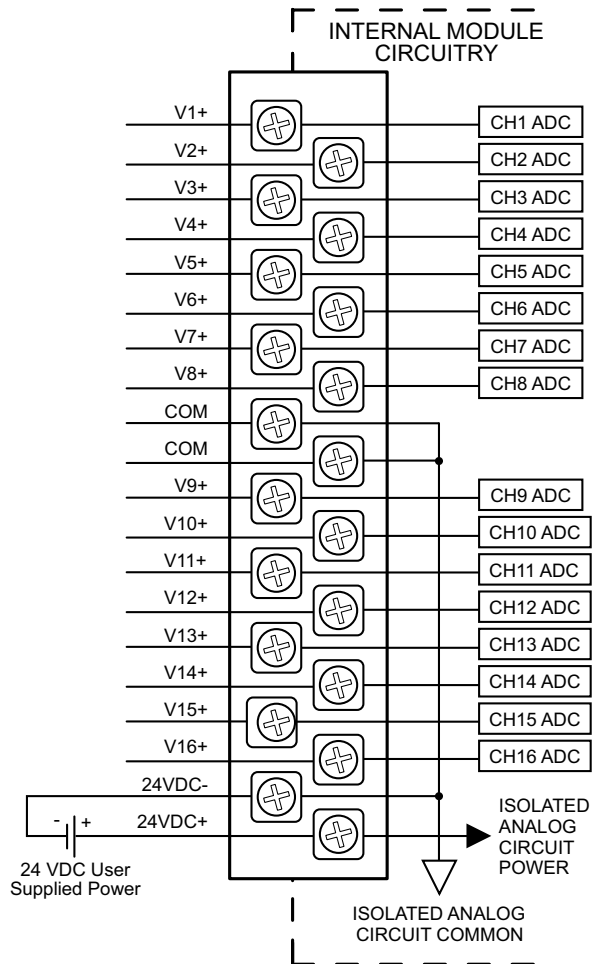

Voltage Input Circuits

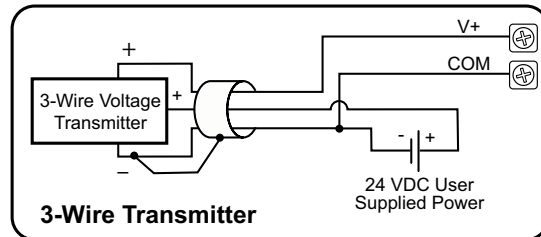
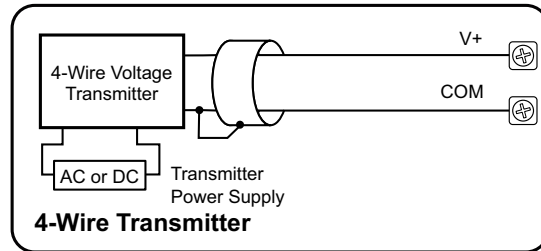

Notes for maximum accuracy:
1. Jumper unused inputs to common.





Wiring Solutions

Wiring Solutions using the ZIPLink wiring system

ZIPLinks eliminate the normally tedious process of wiring between devices by utilizing prewired cables and DIN rail mount connector modules. It's as simple as plugging in a cable connector at either end or terminating wires at only one end. Prewired cables keep installation clean and efficient, using half the space at a fraction of the cost of standard terminal blocks. There are several wiring solutions available when using the **ZIPLink** System ranging from

Solution 1: Productivity Series I/O Modules to ZIPLink Connector Modules

When looking for quick and easy I/O-to-field termination, a **ZIPLink** connector module used in conjunction with a prewired **ZIPLink** cable, consisting of an I/O terminal block at one end and a multi-pin connector at the other end, is the best solution.

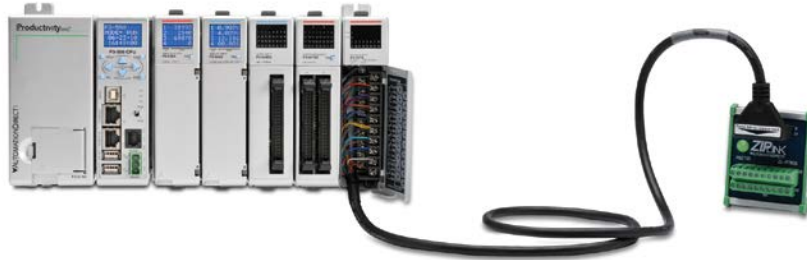

PLC I/O-to-**ZIPLink** Connector Modules that are ready for field termination, options for connecting to third party devices, GS, DuraPulse and SureServo Drives, and specialty relay, transorb and communications modules. Pre-printed I/O-specific adhesive label strips for quick marking of **ZIPLink** modules are provided with **ZIPLink** cables. See the following solutions to help determine the best **ZIPLink** system for your application.

Using the PLC I/O Modules to **ZIPLink** Connector Modules selector tables located in this section,

1. Locate your I/O module/PLC.
2. Select a **ZIPLink** Module.
3. Select a corresponding **ZIPLink** Cable.

Solution 2: Productivity Series I/O Modules to ZIPLink Connector Modules

When wanting to connect I/O to another device within close proximity of the I/O modules, no extra terminal blocks are necessary when using the **ZIPLink** Pigtail Cables. **ZIPLink** Pigtail Cables are prewired to an I/O terminal block with color-coded pigtail with soldered-tip wires on the other end.

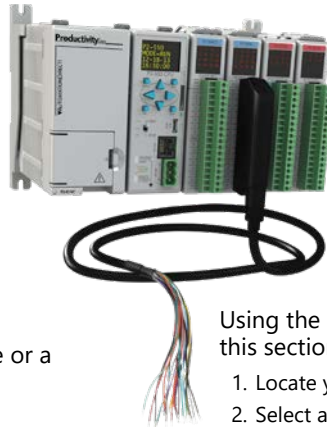

Using the I/O Modules to 3rd Party Devices selector tables located in this section,

1. Locate your PLC I/O module.
2. Select a **ZIPLink** Pigtail Cable that is compatible with your 3rd party device.

Solution 3: GS Series and DuraPulse Drives Communication Cables

Need to communicate via Modbus RTU to a drive or a network of drives?

ZIPLink cables are available in a wide range of configurations for connecting to PLCs and SureServo, SureStep, Stellar Soft Starter and AC drives. Add a **ZIPLink** communications module to quickly and easily set up a multi-device network.

Using the Drives Communication selector tables located in this section,

1. Locate your Drive and type of communications.
2. Select a **ZIPLink** cable and other associated hardware.





Wiring Solutions

Solution 4: Serial Communications Cables

ZIPLink offers communications cables for use with DirectLOGIC, CLICK, and Productivity3000 CPUs, that can also be used with other communications devices. Connections include a 6-pin RJ12 or 9-pin, 15-pin and 25-pin D-sub connectors which can be used in conjunction with the RJ12 or D-Sub Feedthrough modules.

Using the Serial Communications Cables selector table located in this section,

1. Locate your connector type
2. Select a cable.



Solution 5: Specialty ZIPLink Modules

For additional application solutions, **ZIPLink** modules are available in a variety of configurations including stand-alone relays, 24VDC and 120VAC transorb modules, D-sub and RJ12 feedthrough modules, communication port adapter and distribution modules, and SureServo 50-pin I/O interface connection.

Using the **ZIPLink** Specialty Modules selector table located in this section,

1. Locate the type of application.
2. Select a **ZIPLink** module.



Solution 6: ZIPLink Connector Modules to 3rd Party Devices

If you need a way to connect your device to terminal blocks without all that wiring time, then our pigtail cables with color-coded soldered-tip wires are a good solution. Used in conjunction with any compatible **ZIPLink** Connector Modules, a pigtail cable keeps wiring clean and easy and reduces troubleshooting time.

Using the Universal Connector Modules and Pigtail Cables table located in this section,

1. Select module type.
2. Select the number of pins.
3. Select cable.





CPU I/O Modules to ZIPLink Connector Modules - Productivity3000®

Productivity3000 CPU Input Module ZIPLink Selector				
CPU		ZIPLink		
Input Module	# of Terms	Component	Module Part No.	Cable Part No.
P3-08NAS	20	Feedthrough	ZL-RTB20	ZL-P3-CBL20 *
P3-08ND3S	20	Feedthrough		
P3-16NA	20	Feedthrough		
P3-16ND3	20	Feedthrough	ZL-LTB16-24-1	ZL-P3-CBL20-1L ZL-P3-CBL20-2L
		Sensor		
P3-32ND3	40	Feedthrough	ZL-RTB40	ZL-CBL40 ZL-CBL40-1
		Sensor	ZL-LTB32-24-1	
P3-64ND31	40	Feedthrough	ZL-RTB40	ZL-CBL40-2
		Sensor	ZL-LTB32-24-1	

Productivity3000 CPU Analog In Module ZIPLink Selector				
CPU		ZIPLink		
Analog Module	# of Terms	Component	Module	Cable
P3-04ADS	20	Feedthrough	ZL-RTB20	ZL-P3-CBL20-1L ZL-P3-CBL20-2L
P3-08AD	20	Feedthrough		
P3-16AD-1	20	Feedthrough		
P3-16AD-2	20	Feedthrough		
P3-08RTD ²	Matched Only	See Note 2		
P3-08THM ²	T/C Wire Only	See Note 2		
P3-04DA	20	Feedthrough	ZL-RTB20	ZL-P3-CBL20-1L ZL-P3-CBL20-2L
P3-08DA-1	20	Feedthrough		
P3-08DA-2	20	Feedthrough		
P3-16DA-1	20	Feedthrough		
P3-16DA-2	20	Feedthrough		
P3-8AD4DA-1	20	Feedthrough		
P3-8AD4DA-2	20	Feedthrough		

Productivity3000 CPU Specialty Module ZIPLink Selector				
CPU		ZIPLink		
Input Module	# of Terms	Component	Module Part No.	Cable Part No.
P3-HSI	40	Feedthrough	ZL-RTB40	ZL-CBL40-S
P3-HSO				ZL-CBL40-1S ZL-CBL40-2S

Productivity3000 CPU Output Module ZIPLink Selector				
CPU		ZIPLink		
Output Module	# of Terms	Component	Module Part No.	Cable Part No.
P3-08TAS	20	Feedthrough	ZL-RTB20	ZL-P3-CBL20 *
P3-08TD1S	20	Feedthrough		
P3-08TD2S	20	Feedthrough		
P3-08TRS	20	Feedthrough		
P3-16TA	20	Feedthrough	ZL-RTB20	ZL-P3-CBL20 ZL-P3-CBL20-1 ZL-P3-CBL20-2L
		Fuse		
P3-16TD1	20	Feedthrough	ZL-RTB20	ZL-P3-CBL20 ZL-P3-CBL20-1 ZL-P3-CBL20-2
		Fuse		
		Relay (sinking)		
P3-16TD2	20	Feedthrough	ZL-RTB20	ZL-P3-CBL20 ZL-P3-CBL20-1 ZL-P3-CBL20-2
		Fuse	ZL-RFU20 ⁴	
		Relay (sourcing)	ZL-RRL16-24-2	
P3-16TR	20	Feedthrough	ZL-RTB20	ZL-P3-CBL20 ZL-P3-CBL20-1 ZL-P3-CBL20-2
		Fuse	ZL-RFU20 ⁴	
P3-08TRS-1 ³	20	Feedthrough	ZL-RTB20	ZL-P3-CBL20 ZL-P3-CBL20-1 ZL-P3-CBL20-2
		Fuse	ZL-RFU20 ⁴	
P3-32TD1	40	Feedthrough	ZL-RTB40	ZL-CBL40 ZL-CBL40-1 ZL-CBL40-2
		Fuse	ZL-RFU40 ⁴	
P3-32TD2	40	Feedthrough	ZL-RTB40	ZL-CBL40 ZL-CBL40-1 ZL-CBL40-2
		Fuse	ZL-RFU40 ⁴	
P3-64TD1 ¹	40	Feedthrough	ZL-RTB40	ZL-CBL40 ZL-CBL40-1 ZL-CBL40-2
		Fuse	ZL-RFU40 ⁴	
P3-64TD2 ¹	40	Feedthrough	ZL-RTB40	ZL-CBL40 ZL-CBL40-1 ZL-CBL40-2
		Fuse	ZL-RFU40 ⁴	

* Select the cable length by replacing the * with: Blank = 0.5m, -1 = 1.0m, or -2 = 2.0m.

1 The P3-64ND3, P3-64TD1 and P3-64TD2 modules have two 32-point connectors and require two ZIPLink cables and two ZIPLink connector modules.

2 These modules are not supported by the ZIPLink wiring system.

3 The P3-08TRS-1 output module is derated not to exceed 2A per point maximum when used with the ZIPLink wiring system.

4 Note: Fuses (5 x 20 mm) are not included. See Edison Electronic Fuse section for (5 x 20 mm) fuse. S500 and GMA electronic circuit protection for fast-acting maximum protection. S506 and GMC electronic circuit protection for time-delay performance. Ideal for inductive circuits.

To ensure proper operation, do not exceed the voltage and current rating of ZIPLink module. ZL-RFU20 = 2A per circuit; ZL-RFU40 = 400 mA per circuit.



Note: ZIPLink Connector Modules specifications follow the Compatibility Matrix tables. ZIPLink Cables specifications are at the end of this ZIPLink section.

I/O Modules

A variety of discrete, analog and specialty I/O modules are available for use in local, expansion, and remote I/O bases. Specifications for each module are on the following pages.

A filler module is available for unused I/O module slots (part number P3-FILL).

Discrete Input Modules

Productivity3000 Discrete Input Modules			
Part Number	Number of Inputs	Description	Price
P3-16SIM	16	Input Simulator Module	\$197.00
P3-08ND3S	8	Isolated Sinking/Sourcing DC Input	\$99.00
P3-16ND3	16	Sinking/Sourcing DC Input	\$152.00
P3-32ND3	32	Sinking/Sourcing DC Input	\$208.00
P3-64ND3	64	Sinking/Sourcing DC Input	\$260.00
P3-08NAS	8	Isolated AC Input	\$126.00
P3-16NA	16	AC Input	\$159.00

*ZIPLink required.

Analog I/O Modules

Productivity3000 Analog Input Modules			
Part Number	Number of Channels	Description	Price
P3-04ADS	4	Isolated Analog Input	\$724.00
P3-08AD	8	Analog Input	\$393.00
P3-16AD-1	16	Analog Input (Current)	\$535.00
P3-16AD-2	16	Analog Input (Voltage)	\$524.00
P3-08RTD	8	Analog RTD Input	\$581.00
P3-08THM	8	Analog Thermocouple Input	\$736.00

Productivity3000 Analog Output Modules			
Part Number	Number of Channels	Description	Price
P3-04DA	4	Analog Output	\$449.00
P3-08DA-1	8	Analog Output (Current)	\$779.00
P3-08DA-2	8	Analog Output (Voltage)	\$725.00
P3-16DA-1	16	Analog Output (Current)	\$929.00
P3-16DA-2	16	Analog Output (Voltage)	\$911.00

Productivity3000 Analog Input/Output Modules			
Part Number	Number of Channels	Description	Price
P3-8AD4DA-1	8/4	Analog Input/Output (Current)	\$598.00
P3-8AD4DA-2	8/4	Analog Input/Output (Voltage)	\$617.00

Specialty Modules

Productivity3000 Specialty Modules			
Part Number	Number of Channels	Description	Price
P3-HSI	2	High-Speed Pulse Input	\$563.00
P3-HSO*	2	High-Speed Output	\$587.00
P3-SCM	4 ports	Serial Communications Module	\$475.00

*ZIPLink required.

Discrete Output Modules

Productivity3000 Discrete Output Modules			
Part Number	Number of Outputs	Description	Price
P3-08TD1S	8	Isolated Sinking Output	\$135.00
P3-08TD2S	8	Isolated Sourcing Output	\$141.00
P3-16TD1	16	Sinking Output	\$162.00
P3-16TD2	16	Sourcing Output	\$167.00
P3-32TD1*	32	Sinking Output	\$208.00
P3-32TD2*	32	Sourcing Output	\$208.00
P3-64TD1*	*64	Sinking Output	\$280.00
P3-64TD2*	*64	Sourcing Output	\$265.00
P3-08TAS	8	Isolated AC Output	\$177.00
P3-16TA	16	AC Output	\$210.00
P3-08TRS	8	Isolated Relay Output	\$159.00
P3-08TRS-1	8	Isolated Relay Output	\$194.00
P3-16TR	16	Relay Output	\$177.00

*ZIPLink required.

Module Installation Procedure

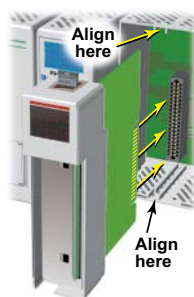

WARNING: DO NOT APPLY FIELD POWER UNTIL THE FOLLOWING STEPS ARE COMPLETED. SEE HOT-SWAPPING PROCEDURE FOR EXCEPTIONS.

Step One: Align circuit card with slot and press firmly to seat module into connector.

Step Two: Pull top and bottom locking tabs toward module face. Click indicates lock is engaged.

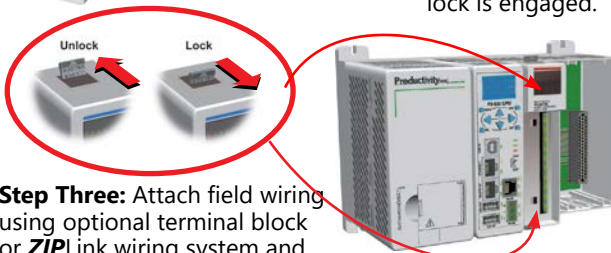

Step Three: Attach field wiring using optional terminal block or ZIPLink wiring system and install cover.

To install or remove terminal block cover, press middle to flex cover.

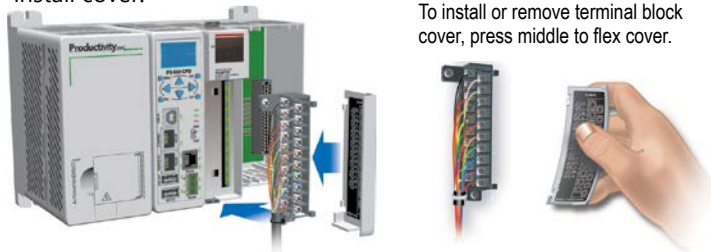

WARNING: EXPLOSION HAZARD – DO NOT CONNECT OR DISCONNECT CONNECTORS OR OPERATE SWITCHES WHILE CIRCUIT IS LIVE UNLESS THE AREA IS KNOWN TO BE NON-HAZARDOUS. DO NOT HOT-SWAP MODULES UNLESS THE AREA IS KNOWN TO BE NON-HAZARDOUS.