

Analog Input Modules

P3-04ADS \$724.00

Isolated Voltage/Current Analog Input

The P3-04ADS Isolated Voltage/Current Analog Input Module provides four isolated channels for receiving ± 10 VDC, 0 to 5 VDC, 0 to 10 VDC and 0 to 20mA signals.

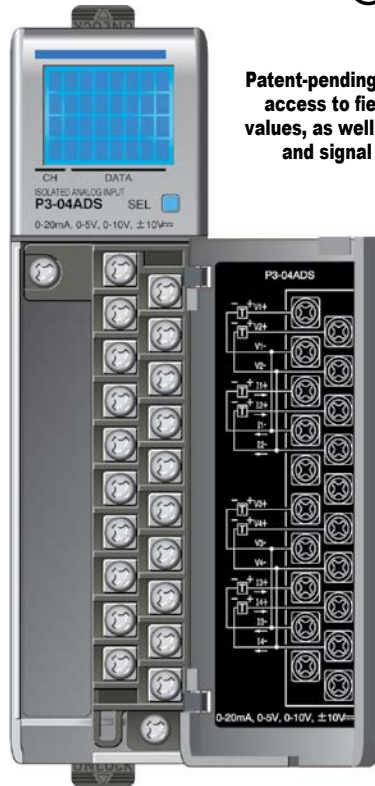

Patent-pending LCD gives access to field signal values, as well as module and signal faults.

Terminal block sold separately; terminal block cover included with module.

We recommend using prewired **ZIPLink** cables and connection modules. See Wiring Solutions.

Terminal block cover included. If you wish to hand-wire your module, a removable terminal block is sold separately. Order part number P3-RTB.



| Removable Terminal Block Specifications | |
|---|---|
| Description | Part No. P3-RTB; 20 screw terminals |
| Wire Range | 22–14 AWG (0.324 to 2.08 sq. mm) Solid / stranded conductor 3/64 in. (1.2 mm) insulation maximum USE COPPER CONDUCTORS, 60°C or equivalent. |
| Screw Driver Width | 1/4 inch (6.5 mm) maximum |
| Screw Size | M3 size |
| Screw Torque | Field terminals - 7–9 in-lb (0.882–1.02 N·m) Self-jacking screws - 2.7–3.6 in-lb (0.3–0.4 N·m). Do not overtighten screws when installing terminal block. |

WARNING: EXPLOSION HAZARD – SUBSTITUTION OF COMPONENTS MAY IMPAIR SUITABILITY FOR CLASS I, DIVISION 2.

| Input Specifications | |
|--|---|
| Input Channels | 4 Channel-to-Channel Isolated |
| Module Signal Input Ranges* | ± 10 VDC, 0–5 VDC, 0–10 VDC, 0–20 mA |
| Resolution | 15 bit + sign (0–10V), 16-bit (all others) |
| Value of LSB (least significant bit) | ± 10 V = 305 μ V, 0–5 V = 152 μ V, 0–10 V = 305 μ V, 0–20 mA = 0.610 μ A |
| Data Range | 0 to 65535 counts unipolar -32768 to +32767 counts bipolar |
| Isolated Loop Pwr for Ext. Xmitters | 20–30 VDC, current limited to < 30mA |
| Input Type | Differential |
| Common Mode Rejection Ratio | -75dB min. @ DC, -500kHz |
| Maximum Continuous Overload | ± 31 mA, current input ± 100 V, voltage input |
| Input Impedance | 250kV $\pm 5\%$ voltage input 250V $\pm 0.1\%$ 1/4W. current input |
| Filter Characteristics | Active low pass, -3dB @ 30Hz, -10dB @ 55Hz |
| Sample Duration Time | 1.28 ms per channel (does not include ladder scan time) |
| All Channel Update Rate | 5.2 ms |
| Open Circuit Detection Time | Zero reading within 1s |
| Conversion Method | Successive Approximation |
| Accuracy vs. Temperature | ± 25 PPM / °C max |
| Maximum Inaccuracy | 0.1% of range voltage, 0.2% of range current (including temperature drift) |
| Linearity Error (End to End) | $\pm 0.025\%$ of range maximum, Monotonic with no missing codes |
| Input Stability and Repeatability | $\pm 0.02\%$ of range maximum after 10 min. |
| Full Scale Calibration Error (not including Offset) | $\pm 0.05\%$ of range maximum |
| Offset Calibration Error | $\pm 0.05\%$ of range maximum |
| Max Crosstalk | -96 dB 1 LSB |
| Channel to Channel Isolation | 900VDC applied for 1s |
| Recommended Fuse (external) | Edison S500-32-R, 0.032A fuse on current inputs only |

*Select any two ranges via hardware jumpers. Range setting is for channels 1 and 3; and channels 2 and 4.

| General Specifications | |
|--------------------------------------|--|
| Operating Temperature | 0°C–60°C (32°F–140°F). |
| Storage Temperature | -20°C–70°C (-4°F–158°F) |
| Humidity | 5 to 95% (non-condensing) |
| Environmental Air | No corrosive gases permitted |
| Vibration | IEC60068-2-6 (Test Fc) |
| Shock | IEC60068-2-27 (Test Ea) |
| Field to Logic Side Isolation | 1800VAC applied for 1s |
| Insulation Resistance | >10M Ω @ 500VDC |
| Heat Dissipation | 2.6 W |
| Enclosure Type | Open equipment |
| Module Keying to Backplane | Electronic |
| Module Location | Any I/O slot in any local, expansion, or remote base in a Productivity3000 system. |
| Field Wiring | Removable terminal block (not included). Use ZIPLink wiring system or optional terminal block. See Wiring Solutions. |
| Terminal Type (not included) | 20-position removable terminal block |
| Weight | 61g (2.14 oz) |
| Agency Approvals | UL508 file E157382, Canada & USA UL1604 file E200031, Canada & USA CE (EN61131-2*) This equipment is suitable for use in Class 1, Division 2, Groups A, B, C and D or non-hazardous locations only. |

*Meets EMC and Safety requirements. See the Declaration of Conformity for details.

Analog Input Modules

P3-04ADS (cont'd)

Wiring Diagrams

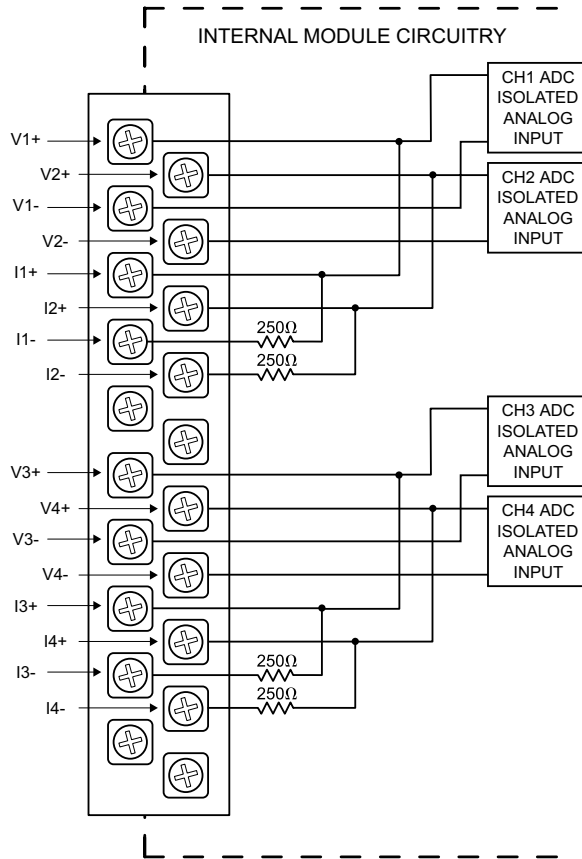

Unused Circuits

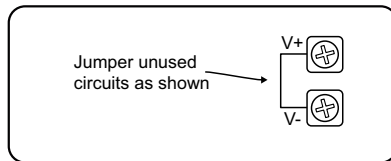

Voltage Input Circuits

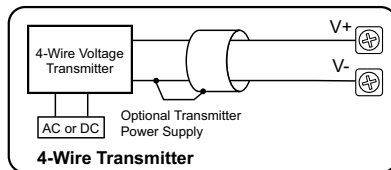

NOTES:

1. Shield connected to signal source common.
2. If current is chosen, I- **MUST** be jumpered to V-. For example, when using 4-20 mA source for Input 3, I3- must be connected to V3-.

Current Input Circuits

An Edison S500-32-R 0.032A fast-acting fuse is recommended for all 4-20mA current loops.

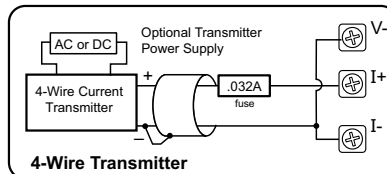
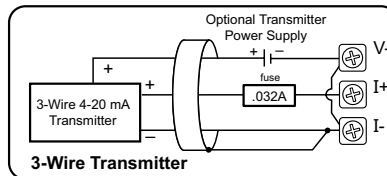
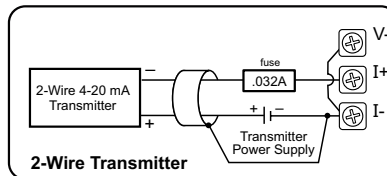



Wiring Solutions

Wiring Solutions using the ZIPLink wiring system

ZIPLinks eliminate the normally tedious process of wiring between devices by utilizing prewired cables and DIN rail mount connector modules. It's as simple as plugging in a cable connector at either end or terminating wires at only one end. Prewired cables keep installation clean and efficient, using half the space at a fraction of the cost of standard terminal blocks. There are several wiring solutions available when using the **ZIPLink** System ranging from

Solution 1: Productivity Series I/O Modules to ZIPLink Connector Modules

When looking for quick and easy I/O-to-field termination, a **ZIPLink** connector module used in conjunction with a prewired **ZIPLink** cable, consisting of an I/O terminal block at one end and a multi-pin connector at the other end, is the best solution.

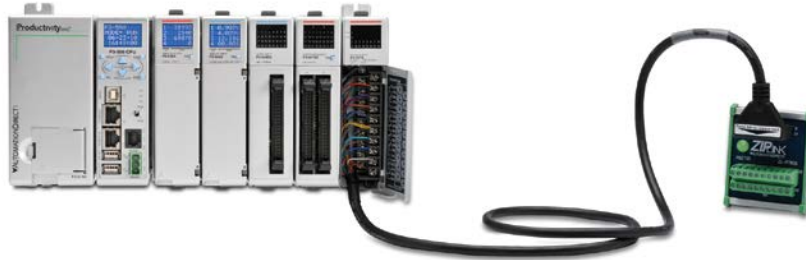

PLC I/O-to-**ZIPLink** Connector Modules that are ready for field termination, options for connecting to third party devices, GS, DuraPulse and SureServo Drives, and specialty relay, transorb and communications modules. Pre-printed I/O-specific adhesive label strips for quick marking of **ZIPLink** modules are provided with **ZIPLink** cables. See the following solutions to help determine the best **ZIPLink** system for your application.

Using the PLC I/O Modules to **ZIPLink** Connector Modules selector tables located in this section,

1. Locate your I/O module/PLC.
2. Select a **ZIPLink** Module.
3. Select a corresponding **ZIPLink** Cable.

Solution 2: Productivity Series I/O Modules to ZIPLink Connector Modules

When wanting to connect I/O to another device within close proximity of the I/O modules, no extra terminal blocks are necessary when using the **ZIPLink** Pigtail Cables. **ZIPLink** Pigtail Cables are prewired to an I/O terminal block with color-coded pigtail with soldered-tip wires on the other end.

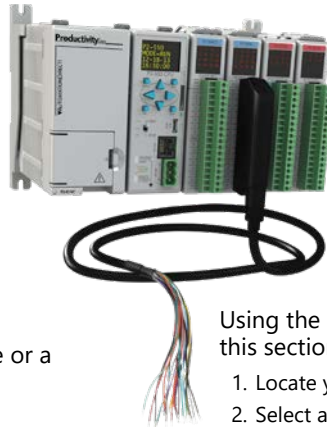

Using the I/O Modules to 3rd Party Devices selector tables located in this section,

1. Locate your PLC I/O module.
2. Select a **ZIPLink** Pigtail Cable that is compatible with your 3rd party device.

Solution 3: GS Series and DuraPulse Drives Communication Cables

Need to communicate via Modbus RTU to a drive or a network of drives?

ZIPLink cables are available in a wide range of configurations for connecting to PLCs and SureServo, SureStep, Stellar Soft Starter and AC drives. Add a **ZIPLink** communications module to quickly and easily set up a multi-device network.

Using the Drives Communication selector tables located in this section,

1. Locate your Drive and type of communications.
2. Select a **ZIPLink** cable and other associated hardware.





Wiring Solutions

Solution 4: Serial Communications Cables

ZIPLink offers communications cables for use with DirectLOGIC, CLICK, and Productivity3000 CPUs, that can also be used with other communications devices. Connections include a 6-pin RJ12 or 9-pin, 15-pin and 25-pin D-sub connectors which can be used in conjunction with the RJ12 or D-Sub Feedthrough modules.

Using the Serial Communications Cables selector table located in this section,

1. Locate your connector type
2. Select a cable.



Solution 5: Specialty ZIPLink Modules

For additional application solutions, **ZIPLink** modules are available in a variety of configurations including stand-alone relays, 24VDC and 120VAC transorb modules, D-sub and RJ12 feedthrough modules, communication port adapter and distribution modules, and SureServo 50-pin I/O interface connection.

Using the **ZIPLink** Specialty Modules selector table located in this section,

1. Locate the type of application.
2. Select a **ZIPLink** module.



Solution 6: ZIPLink Connector Modules to 3rd Party Devices

If you need a way to connect your device to terminal blocks without all that wiring time, then our pigtail cables with color-coded soldered-tip wires are a good solution. Used in conjunction with any compatible **ZIPLink** Connector Modules, a pigtail cable keeps wiring clean and easy and reduces troubleshooting time.

Using the Universal Connector Modules and Pigtail Cables table located in this section,

1. Select module type.
2. Select the number of pins.
3. Select cable.





CPU I/O Modules to ZIPLink Connector Modules - Productivity3000®

| Productivity3000 CPU Input Module ZIPLink Selector | | | | |
|--|------------|-------------|-----------------|----------------------------------|
| CPU | | ZIPLink | | |
| Input Module | # of Terms | Component | Module Part No. | Cable Part No. |
| P3-08NAS | 20 | Feedthrough | ZL-RTB20 | ZL-P3-CBL20 * |
| P3-08ND3S | 20 | Feedthrough | | |
| P3-16NA | 20 | Feedthrough | | |
| P3-16ND3 | 20 | Feedthrough | ZL-LTB16-24-1 | ZL-P3-CBL20-1L ZL-P3-CBL20-2L |
| | | Sensor | | |
| P3-32ND3 | 40 | Feedthrough | ZL-RTB40 | ZL-CBL40 ZL-CBL40-1 |
| | | Sensor | ZL-LTB32-24-1 | |
| P3-64ND31 | 40 | Feedthrough | ZL-RTB40 | ZL-CBL40-2 |
| | | Sensor | ZL-LTB32-24-1 | |

| Productivity3000 CPU Analog In Module ZIPLink Selector | | | | |
|--|---------------|-------------|----------|----------------------------------|
| CPU | | ZIPLink | | |
| Analog Module | # of Terms | Component | Module | Cable |
| P3-04ADS | 20 | Feedthrough | ZL-RTB20 | ZL-P3-CBL20-1L ZL-P3-CBL20-2L |
| P3-08AD | 20 | Feedthrough | | |
| P3-16AD-1 | 20 | Feedthrough | | |
| P3-16AD-2 | 20 | Feedthrough | | |
| P3-08RTD ² | Matched Only | See Note 2 | | |
| P3-08THM ² | T/C Wire Only | See Note 2 | | |
| P3-04DA | 20 | Feedthrough | ZL-RTB20 | ZL-P3-CBL20-1L ZL-P3-CBL20-2L |
| P3-08DA-1 | 20 | Feedthrough | | |
| P3-08DA-2 | 20 | Feedthrough | | |
| P3-16DA-1 | 20 | Feedthrough | | |
| P3-16DA-2 | 20 | Feedthrough | | |
| P3-8AD4DA-1 | 20 | Feedthrough | | |
| P3-8AD4DA-2 | 20 | Feedthrough | | |

| Productivity3000 CPU Output Module ZIPLink Selector | | | | |
|---|------------|-----------------|-----------------------|--|
| CPU | | ZIPLink | | |
| Output Module | # of Terms | Component | Module Part No. | Cable Part No. |
| P3-08TAS | 20 | Feedthrough | ZL-RTB20 | ZL-P3-CBL20 * |
| P3-08TD1S | 20 | Feedthrough | | |
| P3-08TD2S | 20 | Feedthrough | | |
| P3-08TRS | 20 | Feedthrough | | |
| P3-16TA | 20 | Feedthrough | ZL-RFU20 ⁴ | ZL-P3-CBL20 ZL-P3-CBL20-1 ZL-P3-CBL20-2L |
| | | Fuse | | |
| P3-16TD1 | 20 | Feedthrough | ZL-RRL16-24-1 | ZL-P3-CBL20 ZL-P3-CBL20-1 ZL-P3-CBL20-2 |
| | | Fuse | | |
| | | Relay (sinking) | | |
| P3-16TD2 | 20 | Feedthrough | ZL-RTB20 | ZL-P3-CBL20-1 ZL-P3-CBL20-2 |
| | | Fuse | ZL-RFU20 ⁴ | |
| P3-16TR | 20 | Feedthrough | ZL-RTB20 | ZL-P3-CBL20-1 ZL-P3-CBL20-2 |
| | | Fuse | ZL-RFU20 ⁴ | |
| P3-08TRS-1 ³ | 20 | Feedthrough | ZL-RTB20 | ZL-P3-CBL20-1 ZL-P3-CBL20-2 |
| | | Fuse | ZL-RFU20 ⁴ | |
| P3-32TD1 | 40 | Feedthrough | ZL-RTB40 | ZL-CBL40 ZL-CBL40-1 ZL-CBL40-2 |
| | | Fuse | ZL-RFU40 ⁴ | |
| P3-32TD2 | 40 | Feedthrough | ZL-RTB40 | ZL-CBL40 ZL-CBL40-1 ZL-CBL40-2 |
| | | Fuse | ZL-RFU40 ⁴ | |
| P3-64TD1 ¹ | 40 | Feedthrough | ZL-RTB40 | ZL-CBL40 ZL-CBL40-1 ZL-CBL40-2 |
| | | Fuse | ZL-RFU40 ⁴ | |
| P3-64TD2 ¹ | 40 | Feedthrough | ZL-RTB40 | ZL-CBL40 ZL-CBL40-1 ZL-CBL40-2 |
| | | Fuse | ZL-RFU40 ⁴ | |

* Select the cable length by replacing the * with: Blank = 0.5m, -1 = 1.0m, or -2 = 2.0m.

1 The P3-64ND3, P3-64TD1 and P3-64TD2 modules have two 32-point connectors and require two ZIPLink cables and two ZIPLink connector modules.

2 These modules are not supported by the ZIPLink wiring system.

3 The P3-08TRS-1 output module is derated not to exceed 2A per point maximum when used with the ZIPLink wiring system.

4 Note: Fuses (5 x 20 mm) are not included. See Edison Electronic Fuse section for (5 x 20 mm) fuse. S500 and GMA electronic circuit protection for fast-acting maximum protection. S506 and GMC electronic circuit protection for time-delay performance. Ideal for inductive circuits.

To ensure proper operation, do not exceed the voltage and current rating of ZIPLink module. ZL-RFU20 = 2A per circuit; ZL-RFU40 = 400 mA per circuit.

| Productivity3000 CPU Specialty Module ZIPLink Selector | | | | |
|--|------------|-------------|-----------------|----------------------------|
| CPU | | ZIPLink | | |
| Input Module | # of Terms | Component | Module Part No. | Cable Part No. |
| P3-HSI | 40 | Feedthrough | ZL-RTB40 | ZL-CBL40-S |
| P3-HSO | | | | ZL-CBL40-1S ZL-CBL40-2S |



Note: ZIPLink Connector Modules specifications follow the Compatibility Matrix tables. ZIPLink Cables specifications are at the end of this ZIPLink section.



I/O Modules

A variety of discrete, analog and specialty I/O modules are available for use in local, expansion, and remote I/O bases. Specifications for each module are on the following pages.

A filler module is available for unused I/O module slots (part number P3-FILL).

Discrete Input Modules

| Productivity3000 Discrete Input Modules | | | |
|---|------------------|------------------------------------|----------|
| Part Number | Number of Inputs | Description | Price |
| P3-16SIM | 16 | Input Simulator Module | \$197.00 |
| P3-08ND3S | 8 | Isolated Sinking/Sourcing DC Input | \$99.00 |
| P3-16ND3 | 16 | Sinking/Sourcing DC Input | \$152.00 |
| P3-32ND3 | 32 | Sinking/Sourcing DC Input | \$208.00 |
| P3-64ND3 | 64 | Sinking/Sourcing DC Input | \$260.00 |
| P3-08NAS | 8 | Isolated AC Input | \$126.00 |
| P3-16NA | 16 | AC Input | \$159.00 |

*ZIPLink required.

Analog I/O Modules

| Productivity3000 Analog Input Modules | | | |
|---------------------------------------|--------------------|---------------------------|----------|
| Part Number | Number of Channels | Description | Price |
| P3-04ADS | 4 | Isolated Analog Input | \$724.00 |
| P3-08AD | 8 | Analog Input | \$393.00 |
| P3-16AD-1 | 16 | Analog Input (Current) | \$535.00 |
| P3-16AD-2 | 16 | Analog Input (Voltage) | \$524.00 |
| P3-08RTD | 8 | Analog RTD Input | \$581.00 |
| P3-08THM | 8 | Analog Thermocouple Input | \$736.00 |

| Productivity3000 Analog Output Modules | | | |
|--|--------------------|-------------------------|----------|
| Part Number | Number of Channels | Description | Price |
| P3-04DA | 4 | Analog Output | \$449.00 |
| P3-08DA-1 | 8 | Analog Output (Current) | \$779.00 |
| P3-08DA-2 | 8 | Analog Output (Voltage) | \$725.00 |
| P3-16DA-1 | 16 | Analog Output (Current) | \$929.00 |
| P3-16DA-2 | 16 | Analog Output (Voltage) | \$911.00 |

| Productivity3000 Analog Input/Output Modules | | | |
|--|--------------------|-------------------------------|----------|
| Part Number | Number of Channels | Description | Price |
| P3-8AD4DA-1 | 8/4 | Analog Input/Output (Current) | \$598.00 |
| P3-8AD4DA-2 | 8/4 | Analog Input/Output (Voltage) | \$617.00 |

Specialty Modules

| Productivity3000 Specialty Modules | | | |
|------------------------------------|--------------------|------------------------------|----------|
| Part Number | Number of Channels | Description | Price |
| P3-HSI | 2 | High-Speed Pulse Input | \$563.00 |
| P3-HSO* | 2 | High-Speed Output | \$587.00 |
| P3-SCM | 4 ports | Serial Communications Module | \$475.00 |

*ZIPLink required.

Discrete Output Modules

| Productivity3000 Discrete Output Modules | | | |
|--|-------------------|--------------------------|----------|
| Part Number | Number of Outputs | Description | Price |
| P3-08TD1S | 8 | Isolated Sinking Output | \$135.00 |
| P3-08TD2S | 8 | Isolated Sourcing Output | \$141.00 |
| P3-16TD1 | 16 | Sinking Output | \$162.00 |
| P3-16TD2 | 16 | Sourcing Output | \$167.00 |
| P3-32TD1* | 32 | Sinking Output | \$208.00 |
| P3-32TD2* | 32 | Sourcing Output | \$208.00 |
| P3-64TD1* | *64 | Sinking Output | \$280.00 |
| P3-64TD2* | *64 | Sourcing Output | \$265.00 |
| P3-08TAS | 8 | Isolated AC Output | \$177.00 |
| P3-16TA | 16 | AC Output | \$210.00 |
| P3-08TRS | 8 | Isolated Relay Output | \$159.00 |
| P3-08TRS-1 | 8 | Isolated Relay Output | \$194.00 |
| P3-16TR | 16 | Relay Output | \$177.00 |

*ZIPLink required.

Module Installation Procedure

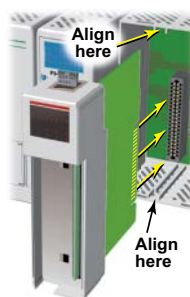

WARNING: DO NOT APPLY FIELD POWER UNTIL THE FOLLOWING STEPS ARE COMPLETED. SEE HOT-SWAPPING PROCEDURE FOR EXCEPTIONS.

Step One: Align circuit card with slot and press firmly to seat module into connector.

Step Two: Pull top and bottom locking tabs toward module face. Click indicates lock is engaged.

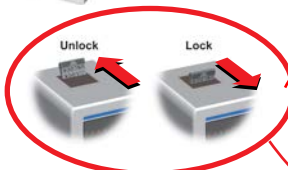

Step Three: Attach field wiring using optional terminal block or ZIPLink wiring system and install cover.



To install or remove terminal block cover, press middle to flex cover.

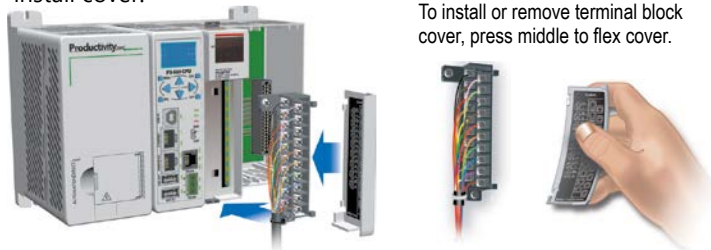

WARNING: EXPLOSION HAZARD – DO NOT CONNECT OR DISCONNECT CONNECTORS OR OPERATE SWITCHES WHILE CIRCUIT IS LIVE UNLESS THE AREA IS KNOWN TO BE NON-HAZARDOUS. DO NOT HOT-SWAP MODULES UNLESS THE AREA IS KNOWN TO BE NON-HAZARDOUS.