

# P2-SCM Serial Communication Module

**P2-SCM**      **\$234.00**

**Serial Communications Module**

Productivity® 2000 serial communications module provides three RS-232 ports and one RS-485 port. This configuration allows Modbus master/slave networking or connection to serial devices using ASCII or custom communication protocols.

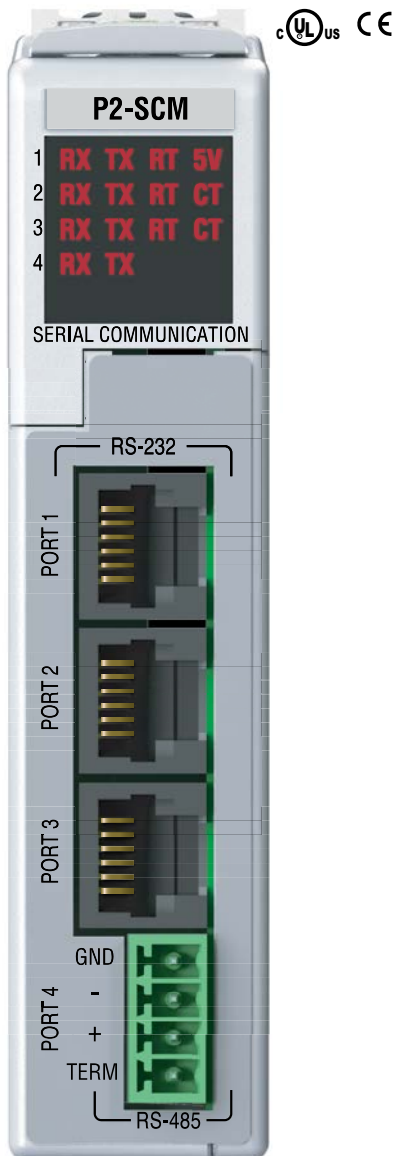

General Specifications	
<b>Module Type</b>	Intelligent
<b>Modules per Base</b>	15 maximum (See Note)
<b>I/O Points Used</b>	None, mapped directly to tags in CPU
<b>Field Wiring Connector</b>	3 - RJ12, 1 - 4 Position Terminal Block
<b>Operating Temperature</b>	0° to 60°C (32° to 140°F)
<b>Storage Temperature</b>	-20° to 70°C (-4° to 158°F)
<b>Humidity</b>	5 to 95% (non-condensing)
<b>Environmental Air</b>	No corrosive gases permitted
<b>Vibration</b>	IEC 60068-2-6 (Test Fc)
<b>Shock</b>	IEC 60068-2-27 (Test Ea)
<b>Field to Logic Side Isolation</b>	None
<b>Insulation Resistance</b>	No isolation
<b>Module Location</b>	Any slot in any base in a Productivity2000 system
<b>Weight</b>	90g (3.2 oz)
<b>Agency Approvals**</b>	UL508 File E139594, Canada & USA CE (EN61131-2007)*

\*Meets EMC and Safety requirements. See the Declaration of Conformity for details.  
 \*\*To obtain the most current agency approval information, see the Agency Approval Checklist section on the specific component part number web page.

Removable Terminal Block Specifications	
<b>Number of Positions</b>	4 Screw Terminals, 3.5mm pitch
<b>Wire Range</b>	16-28 AWG Solid/Stranded Conductor "Use copper conductors, 75°C or equivalent"
<b>Screwdriver Size</b>	TW-SD-VSL-1 (recommended)
<b>Screw Torque</b>	0.4 N·m

Removable Terminal Connector included. Spare connectors available (part no. [P3-RS485CON-1](#)).

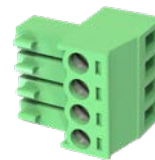

RS-485 Cable Options	
<b>Recommended</b>	<a href="#">Q8302-1</a> (cut to length) or Belden #9841 equivalent.

# P2-SCM Serial Communication Module

Diagnostic LEDs				
LED	Port 1	Port 2	Port 3	Port 4
RXD	X	X	X	X
TXD	X	X	X	X
RTS	X	X	X	
CTS		X	X	
5V	X			

- All RS232 & RS485 LED's reflect the actual electrical level of the signal; there is no direct firmware control of LED's.
- RS232 LED's RXD, TXD, RTS & CTS are turned ON when the voltage on the RS232 wire is positive:
  - This occurs when the UART I/O signal is low (GND).
  - They are turned OFF when the voltage on the RS232 wire is negative.
- RS485 LED's RXD & TXD are turned ON when the UART I/O signal is low (GND).
- 5V LED is ON when 5V power is good, 5V LED is OFF when 5V is shorted to ground.

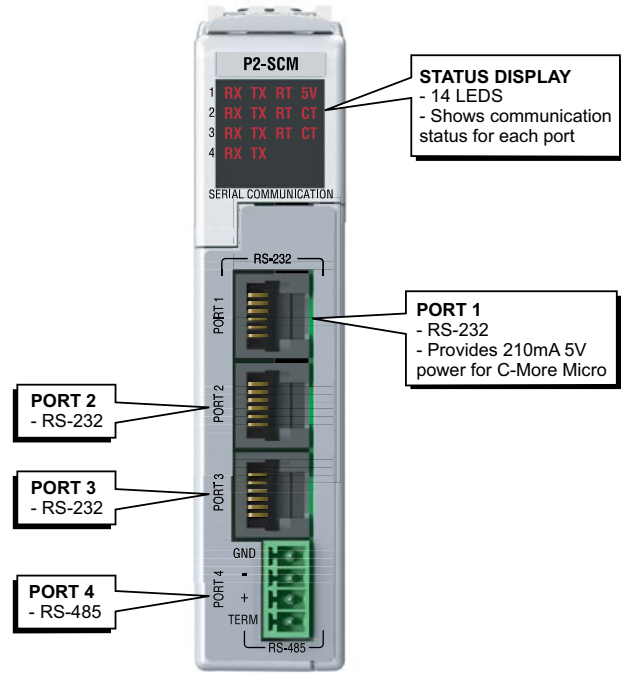

P2-SCM Configuration Options			
Configuration Item	Port 1 (RS-232)	Ports 2 & 3 (RS-232)	Port 4 (RS-485)
<b>Protocol Selections</b>	Disabled, Modbus RTU, ASCII/Custom	Disabled, Modbus RTU, ASCII/Custom	Disabled, Modbus RTU, ASCII/Custom
<b>Data Rate</b>	1200, 2400, 4800, 9600, 19200, 33600, 38400 baud	1200, 2400, 4800, 9600, 19200, 33600, 38400 baud	1200, 2400, 4800, 9600, 19200, 33600, 38400 baud
<b>Parity</b>	None, Odd or Even	None, Odd or Even	None, Odd or Even
<b>Data Bits<sup>4</sup></b>	7 or 8 bits	7 or 8 bits	7 or 8 bits
<b>RTS Off Delay Time<sup>1</sup></b>	None, or 0–5000 ms	None, or 0–5000 ms	N/A
<b>RTS On Delay Time<sup>1</sup></b>	None, or 0–5000 ms	None, or 0–5000 ms	N/A
<b>Modbus Character Timeout<sup>2</sup></b>	None, or 0–10000 ms	None, or 0–10000 ms	None, or 0–10000 ms
<b>Communication Timeout (Timeout between query and response)</b>	500–10500 ms	500–10500 ms	500–10500 ms
<b>Response/Request Delay Time</b>	N/A	N/A	None, or 1–5000 ms
<b>Comm Heartbeat Value<sup>2</sup></b>	2–1000 sec	2–1000 sec	2–1000 sec
<b>Node Address (Station)</b>	1 to 247	1 to 247	1 to 247
<b>CTS</b>	N/A	Ignore, Wait, System Input <sup>3</sup>	N/A
<b>Enable/Disable CTS Wait Timeout</b>	1–9999 tenths of seconds	1–9999 tenths of seconds	N/A
<b>RTS</b>	On, Off, Assert During Transmit, System Output	On, Off, Assert During Transmit, System Output	N/A
<b>RS-485 2-Wire Mode</b>	N/A	N/A	Disable, Enable
<b>Modbus Port Security</b>	Read/Write, Read Only	Read/Write, Read Only	Read/Write, Read Only

1. For "None" selection with Modbus RTU protocol, [www.modbus.org](http://www.modbus.org) minimums are used. This minimum is 3.5 character times up to 19,200 baud rate and 1.75 ms over 19200 baud rate.  
 2. Only applies to Modbus messages.  
 3. CTS signal is only provided on Ports 2 & 3.  
 4. 7-bit data are only supported with Odd or Even parity.

# P2-SCM Serial Communication Module

Serial Port 1	
<b>Port Type</b>	RS-232
<b>Description</b>	Non-isolated RS-232 DTE port connects the CPU as a Modbus/ASCII master or slave to a peripheral device. Includes ESD and built-in surge protection.
<b>Data Rates</b>	Selectable, 1200, 2400, 4800, 9600, 19200, 33600, and 38400
<b>+5V Cable Power Source</b>	210mA maximum at 5V, ±5%. Reverse polarity and overload protected
<b>TXD</b>	RS-232 Transmit output
<b>RX</b>	RS-232 Receive input
<b>RTS</b>	Handshaking output for modem control
<b>GND</b>	Logic ground
<b>Maximum Output Load (TXD/RTS)</b>	3kΩ, 1000pF
<b>Minimum Output Voltage Swing</b>	±5V
<b>Output Short Circuit Protection</b>	±15mA
<b>Port Status LED</b>	Red LED is illuminated when active for TXD, RXD and RTS
<b>Cable Options</b>	<a href="#">EA-MG-PGM-CBL</a> <a href="#">D2-DSCBL</a> <a href="#">USB-RS232</a> with D2-DSCBL <a href="#">FA-CABKIT</a> <a href="#">FA-ISOCAN</a> for converting RS-232 to isolated RS-485

## Port 1

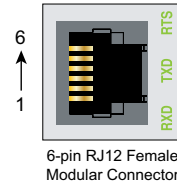

Pin #	Signal	
6	GND	Logic Ground
5	RTS	RS-232 Output
4	TXD	RS-232 Output
3	RXD	RS-232 Input
2	+5V	210mA Maximum
1	GND	Logic Ground

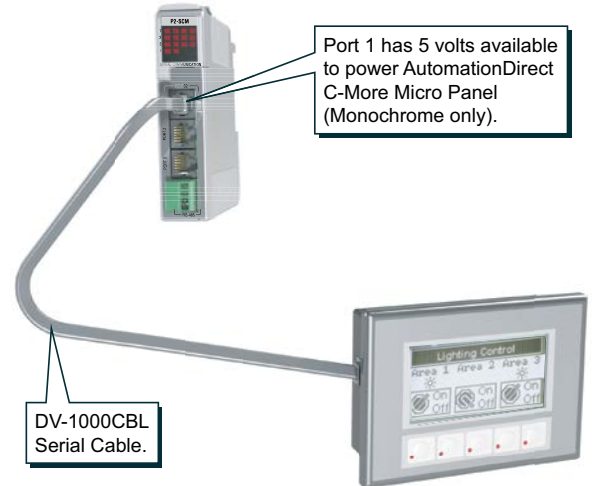

## Ports 2, and 3

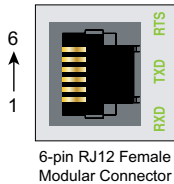

Pin #	Signal	
6	GND	Logic Ground
5	RTS	RS-232 Output
4	TXD	RS-232 Output
3	RXD	RS-232 Input
2	CTS	RS-232 Input
1	GND	Logic Ground

Serial Port 2 and 3	
<b>Port Type</b>	RS-232
<b>Description</b>	Non-isolated RS-232 DTE port connects the CPU as a Modbus/ASCII master or slave to a peripheral device. Includes ESD and built-in surge protection.
<b>Data Rates</b>	Selectable, 1200, 2400, 4800, 9600, 19200, 33600, and 38400
<b>TXD</b>	RS-232 Transmit output
<b>RX</b>	RS-232 Receive input
<b>RTS</b>	Handshaking output for modem control
<b>GND</b>	Logic ground
<b>Maximum Output Load (TXD/RTS)</b>	3kΩ, 1,000pF
<b>Minimum Output Voltage Swing</b>	±5V
<b>Output Short Circuit Protection</b>	±15mA
<b>Port Status LED</b>	Red LED is illuminated when active for TXD, RXD and RTS
<b>Cable Options</b>	<a href="#">D2-DSCBL</a> <a href="#">USB-RS232</a> with D2-DSCBL <a href="#">FA-CABKIT</a> <a href="#">FA-ISOCAN</a> for converting RS-232 to isolated RS-485

RS-232 Ports 1, 2 & 3				
Electrical Specifications	Min	Typ	Max	Units
<b>Output ON, Space Condition (3kΩ, 1000pF Load)</b>	5.0	5.2	N/A	Volts
<b>Output OFF, Mark Condition (3kΩ, 1000pF Load)</b>	N/A	-5.2	-5.0	Volts
<b>Output Short-Circuit Current</b>	N/A	15	N/A	mA
<b>Short-Circuit Duration</b>	N/A	N/A	No Limit	Seconds
<b>Output Resistance</b>	300	N/A	N/A	Ohm
<b>Input ON Threshold</b>	N/A	1.6	2.4	Volt
<b>Input OFF Threshold</b>	0.6	1.2	N/A	Volt
<b>Input Resistance</b>	3k	5k	7k	Ohm

Line Specifications for RS-232 Ports		
RS-232 Line Specifications	Options	Units
<b>Data Rate Setting</b>	1200, 2400, 4800, 9600, 19200, 33600, 38400	Baud
<b>Data Rate Error</b>	±2	%
<b>Data Bits Setting1</b>	7 or 8	Bits
<b>Stop Bits Setting</b>	1	Bits
<b>Parity Setting</b>	None1, Odd or Even	Parity
<b>Data Transmission</b>	Half duplex or full duplex	N/A
<b>Network</b>	Point-to-Point	

1. 7-bit data are only supported with odd or even parity.

# P2-SCM Serial Communication Module

Port 4	
<b>Port Type</b>	RS-485
<b>Description</b>	Non-isolated RS-485 port connects the CPU as a Modbus/ASCII master or slave to a peripheral device. Includes ESD/EFT protection and automatic echo cancellation when transmitter is active.
<b>Data Rates</b>	Selectable, 1200, 2400, 4800, 9600, 19200, 33600, 38400 baud
<b>TXD+/RXD</b>	RS-485 transceiver high
<b>TXD-/RXD-</b>	RS-485 transceiver low
<b>GND</b>	Logic Ground
<b>Input Impedance</b>	19kΩ
<b>Maximum Load</b>	50 transceivers, 19kΩ each, 60Ω termination
<b>Output Short Circuit Protection</b>	±250mA, thermal shut-down protection
<b>Electrostatic Discharge Protection</b>	±8kV per IEC1000-4-2
<b>Electrical Fast Transient Protection</b>	±2kV per IEC1000-4-4
<b>Minimum Differential Output Voltage</b>	1.5 V with 60Ω load
<b>Fail Safe Inputs</b>	Logic high input state if inputs are unconnected
<b>Maximum Common Mode Voltage</b>	-7.5 V to 12.5 V
<b>Port Status LED</b>	RED LED Illuminated when active for TXD and RXD
<b>Cable Options</b>	Recommend ADC #Q8302-1 (cut to length)

Port 4

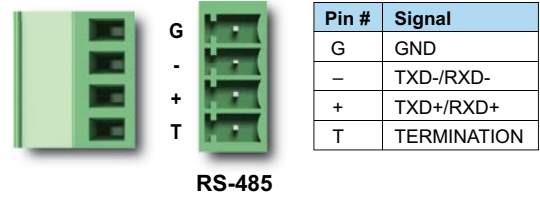

Line Specifications for RS-485 Port		
<b>RS-485 Line Specifications</b>	Options	Units
<b>Data Rate Setting</b>	1200, 2400, 4800, 9600, 19200, 33600, 38400	Baud
<b>Data Bits Setting<sup>1</sup></b>	7 or 8	Bits
<b>Stop Bits Setting</b>	1	Bits
<b>Parity Setting</b>	None <sup>1</sup> , Odd or Even	Parity
<b>Data Transmission</b>	Half duplex	N/A

1. 7-bit data is only supported with odd or even parity.

Port 4				
Electrical Specifications	Min	Typ	Max	Units
<b>Driver Differential Output (54Ω Load)</b>	1.5	N/A	N/A	Volts
<b>Driver Common-Mode Output</b>			3	Volts
<b>Driver Short-Circuit Output Current</b>	N/A		250	mA
<b>Short-Circuit Duration (Thermal Shutdown)</b>			No Limit	Seconds
<b>Receiver Differential Input Threshold</b>	200		N/A	mV
<b>Receiver Common-Mode Input</b>	-7		12	Volt
<b>Input Resistance</b>	12k			Ohm
<b>Termination Resistance (TB Jumper wire 'T' to '+')</b>	N/A	120	N/A	Ohm
<b>Data Rate</b>	1200	N/A	38400	Baud
<b>Data Rate Error</b>			±2	%
<b>Cable Length (38400 baud maximum)</b>	N/A		1200	Meter

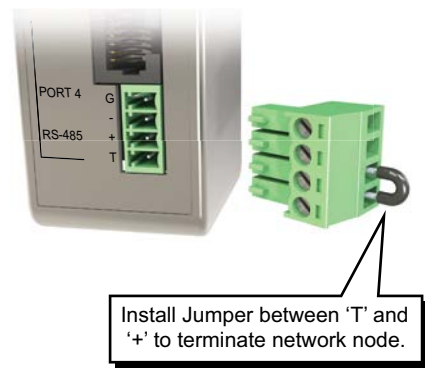

Install Jumper between 'T' and '+' to terminate network node.

\* Jumper not included