

Remote Slave Module

P2-RS \$321.00

The P2-RS is a full featured, high-performance, Remote Slave module for use with the Productivity2000 Programmable Controller system. The module has an RJ45 Ethernet Remote I/O port with two communications ports which support serial devices. An additional Micro USB IN (type B) port for remote CPU programming and monitoring. The P2-RS also includes a 4 line x 10 character backlit OLED display.

Up to 8 Remote Slaves can be connected to a single CPU for a remote I/O network.

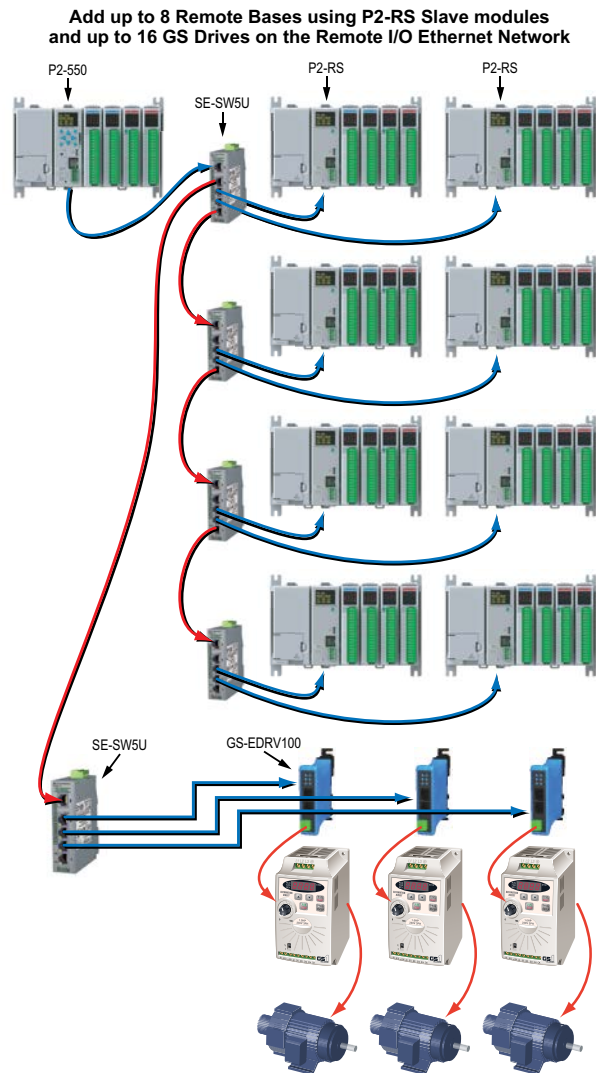
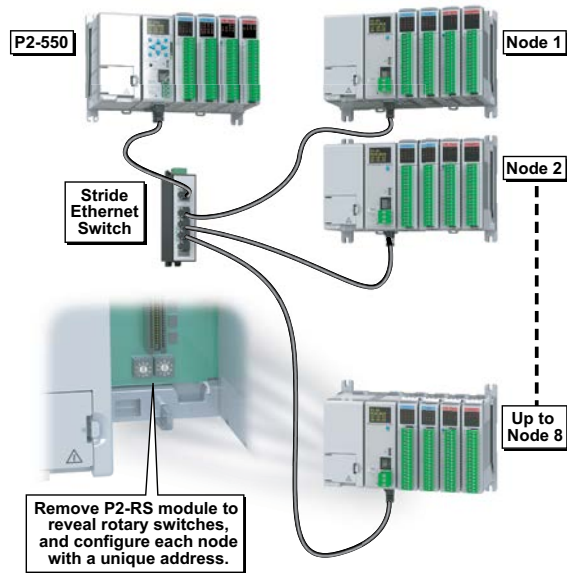
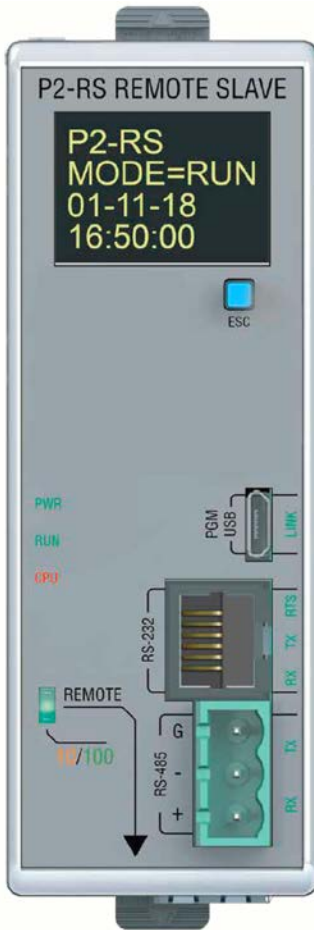

Remote Slave Module

Remote Slave Specifications	
Mounting Location	Controller slot in remote base
Display	OLED, 4x10 characters, backlit, 1 OLED wake up button, OLED characters are 7x12 with a dot pitch of 0.245 mm; 1.7 mm x 2.94 mm
Communications	USB: Programming, Monitoring, Debug REMOTE I/O: (10/100 Mbps Ethernet) RS-232: (RJ12, 1200-115.2k baud) ASCII, Modbus RS-485: (Removable Terminal Included, 1200-115.2k baud) ASCII, Modbus
Max. Number of Ethernet Remote I/O Bases	8
Max. Number of I/O per CPU System	4,320 (CPU Base with 8 Remote I/O Bases with 15 32 point I/O modules per base).

General Specifications	
Operating Temperature	0° to 60°C (32° to 140°F)
Storage Temperature	-20° to 70°C (-4° to 158°F)
Humidity	5 to 95% (non-condensing)
Altitude	2,000 meters, max
Pollution Degree	2
Environmental Air	No corrosive gases permitted
Vibration	IEC60068-2-6 (Test Fc)
Shock	IEC60068-2-27 (Test Ea)
Heat Dissipation	3.81 W
Overvoltage Category	II
Enclosure Type	Open equipment
Module Location	Controller slot in a remote base in a Productivity2000 system
Weight	158g (5.6 oz)
Agency Approvals	UL 61010-1 and UL 61010-2-201 File E139594, Canada and USA CE (EN 61131-2 EMC, EN 61010-1 and EN 61010-2-201 Safety)*

*Meets EMC and Safety requirements. See the Declaration of Conformity for details.
NOTE: When using a P2-RS module, use most recent software and CPU firmware version releases.

IMPORTANT!



Hot-Swap Information

NOTE: This device cannot be Hot Swapped.

Remote Slave Module

Front Panel

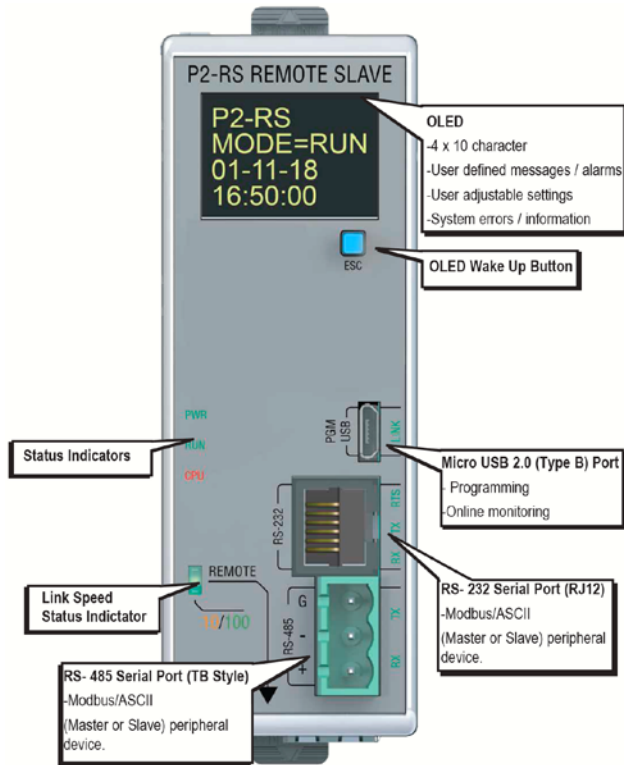

Status Indicators

RS Status Indicators	
PWR	Green LED is backlit when power is on
RUN	Green LED is backlit to indicate when CPU has valid project file with RS configured.
CPU	Red LED is backlit during power on reset, power down, or watch-dog time-out.

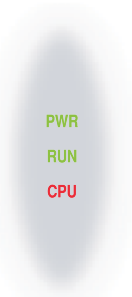

OLED Message Display

The P2-RS incorporates a 4 line x 10 character OLED for system errors and information or for displaying user-defined messages.

OLED characters are 7x12 with a dot pitch of 0.245 mm; 1.72 mm x 2.94 mm.

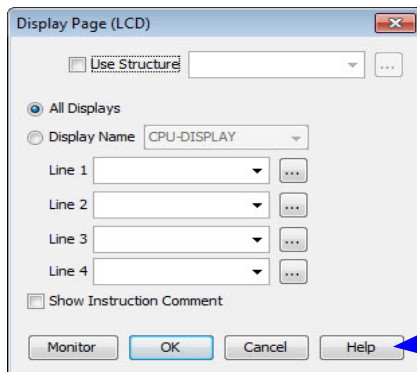

For user-defined messages, the display is configured using the Productivity Suite Programming Software. An LCD Page instruction allows the user to program text into user-defined tags and display the messages based on the ladder execution.

See the Productivity Suite Programming Software Help Files for complete details.

Remote Slave Module

Setting the Remote Slave Address

Each Remote Slave (P2-RS) must have a unique address between 1 and 99. The address is set using the two rotary switches located on the base of the module. The left dial is X10 for setting the tens units and the right dial is X1 for setting the ones unit.

For example, to set a remote slave address to 21, turn the X10 arrow until it points at number 2 and the X1 arrow until it points at number 1.

IMPORTANT NOTES:

- The factory setting of 00 is not a valid address for a Remote Slave.
- The address must be set prior to inserting P2-RS module in base unit.
- When using a P2-RS module, address selection must be set prior to power-up.
- Slave addresses are only read on power-up.
- If there are duplicate slave addresses on the same network, a critical error will occur.

It is also necessary to configure the remote addresses using the



Productivity Suite Programming Software.

If setting up offline, go to Hardware Configuration, select the Base Chassis size needed (2), left click and drag the selected base to the Remote Base Group field (3). In the Add Remote Base Group (4) window, select the same Remote Base Number as set on the rotary switches.

If connected online with a Productivity2000 system that has slave modules installed, go to Hardware Configuration and select the Read Configuration (1) button. The CPU will automatically read the addresses of the remote slaves and add them to the configuration.

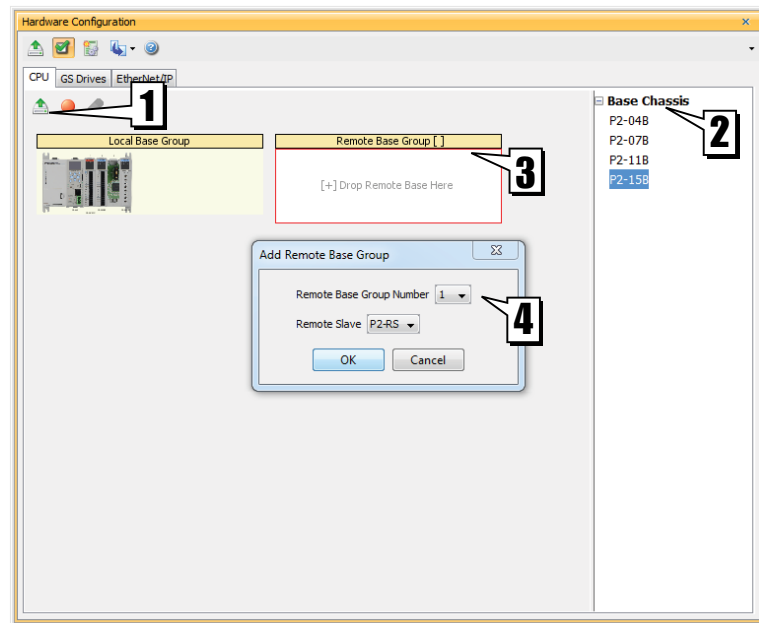

Remote Slave Module

Port Specifications

The P2-RS has several communications ports. The following pages have specifications and pin-out diagrams for these ports.

P2-RS

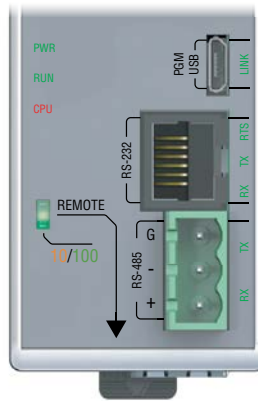

USB IN Port

A Micro USB 2.0 (Type B) Slave input for remote CPU programming and online monitoring, with built-in surge protection.

USB IN Specifications	
Description	Standard Micro USB 2.0 (Type B) Slave input for remote CPU programming and online monitoring, with built-in surge protection. Not compatible with older full speed USB devices.
Transfer Rate	480Mbps
Port Status LED	Green LED is illuminated when LINK is established to programming software.
Cables	Micro USB 2.0 (Type B) to USB Type A: 6ft cable part # USB-CBL-AMICB6 15ft cable part # USB-CBL-AMICB15

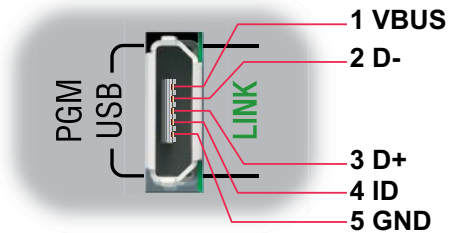

Remote I/O Port

Isolated Ethernet Port with built-in surge protection for connection to P2-550 CPU Remote I/O Master port.

Remote I/O Port Specifications	
Description	Proprietary transformer isolated Ethernet Port with built-in surge protection for connection to CPU Remote I/O Master port.
Transfer Rate	10/100 Mbps
Port Status LEDs	Green LED is illuminated when network LINK is established. Yellow LED backlit when port is active (ACT).
Cables	Auto cross-over port allows use of a Patch (straight through) cable.

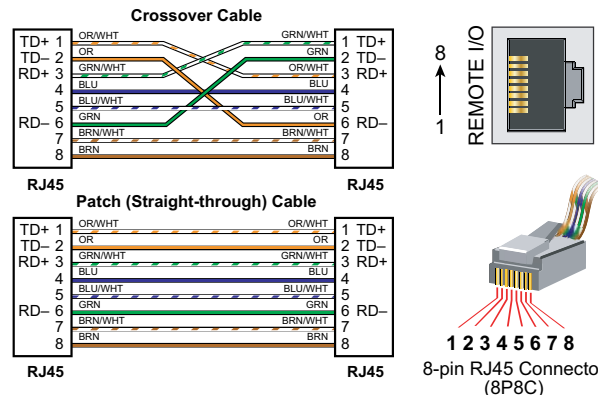

Remote Slave Module

RS-232 Serial Port

Non-isolated RS-232 DTE port connects the P2-RS as a Modbus or ASCII master or slave to a peripheral device.

RS-232 Specifications	
Description	Non-isolated RS-232 DTE port connects the P2-RS as a Modbus or ASCII master or slave to a peripheral device. Includes ESD and built-in surge protection.
Data Rates	Selectable, 1200, 2400, 9600, 19200, 33600, 38400, 57600, and 115200 bps.
+5V Cable Power Source	210mA maximum at 5V, ±5%. Limited by resettable fuse Reverse polarity protected.
TXD	RS-232 Transmit output
RXD	RS-232 Receive input
RTS	Handshaking output for modem control.
GND	Logic ground
Maximum Output Load (TXD/RTS)	3kΩ, 1,000pf
Minimum Output Voltage Swing	±5V
Output Short Circuit Protection	±15mA
Port Status LED	Green LED is illuminated when active for TXD, RXD and RTS
Cable Options	D2-DSCBL USB-RS232 with D2-DSCBL FA-CABKIT FA-ISOCAN for converting RS-232 to isolated RS-485

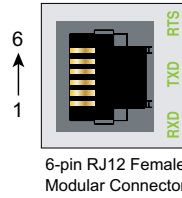

Pin #	Signal
1	GND Logic Ground
2	+5V 210 mA Maximum
3	RXD RS-232 Input
4	TXD RS-232 Output
5	RTS Request to Send
6	GND Logic Ground

Remote Slave Module

RS-485 Serial Port

Non-isolated RS-485 port connects the P2-RS as a Modbus or ASCII master or slave to a peripheral device.

Removable connector included. Spare connectors available (part no. P3-RS485CON).

RS-485 Specifications	
Description	Non-isolated RS-485 port connects the P2-RS as a Modbus or ASCII master or slave to a peripheral device. Includes ESD/EFT protection and automatic echo cancellation when transmitter is active.
Data Rates	Selectable, 1200, 2400, 9600, 19200, 33600, 38400, 57600, and 115200 bps.
TXD+/RXD+	RS-485 transceiver high
TXD-/RXD-	RS-485 transceiver low
GND	Logic ground
Input Impedance	19kΩ
Maximum load	50 transceivers, 19kΩ each, 60Ω termination
Output Short Circuit Protection	±250mA, thermal shut-down protection
Electrostatic Discharge Protection	Contact ±4kV, Air ±8kV per IEC1000-4-2 Cable is installed for testing.
Electrical Fast Transient Protection	±1kV, per IEC1000-4-4
Minimum Differential Output Voltage	1.5 V with 60Ω load
Fail safe inputs	Logic high input state if inputs are unconnected
Maximum Common Mode Voltage	-7.5 V to 12.5 V.
Port Status LED	Green LED is illuminated when active for TXD and RXD
Cable Options	Go to AutomationDirect.com for RS-485 cables.

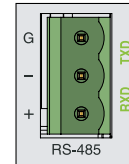
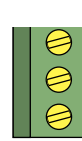
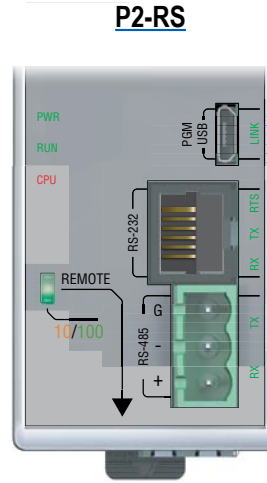

Pin #	Signal
G	GND
-	TXD-/RXD-
+	TXD+/RXD+

Removable connector included. Spare connectors available (part no. P3-RS485CON).

Terminal Block Specifications	
Part Number	P3-RS485CON
Number of positions	3 Screw terminals
Pitch	5mm
Wire Range	28-12 AWG Solid Conductor 30-12 AWG Stranded Conductor
Screw Driver Width	1/8 inch (3.175 mm) maximum
Screw Size	M2.5
Screw Torque	4.5 lb-in (0.51 N-m)

Installation Procedure

Step One:

Locate the two sockets next to the power supply; the module will be inserted into this location.



Step Two:

Seat the P2-RS module on support platform and push towards base until PCB is fully engaged into the connector.



Step Three:

Snap retaining tab into the locked position.

