

P2-622 CPU Module

P2-622 \$299.00

The P2-622 is a high-performance CPU which has communications ports that support Ethernet and serial devices. The P2-622 also includes a 4-line x 10-character OLED local display and a USB programming port.

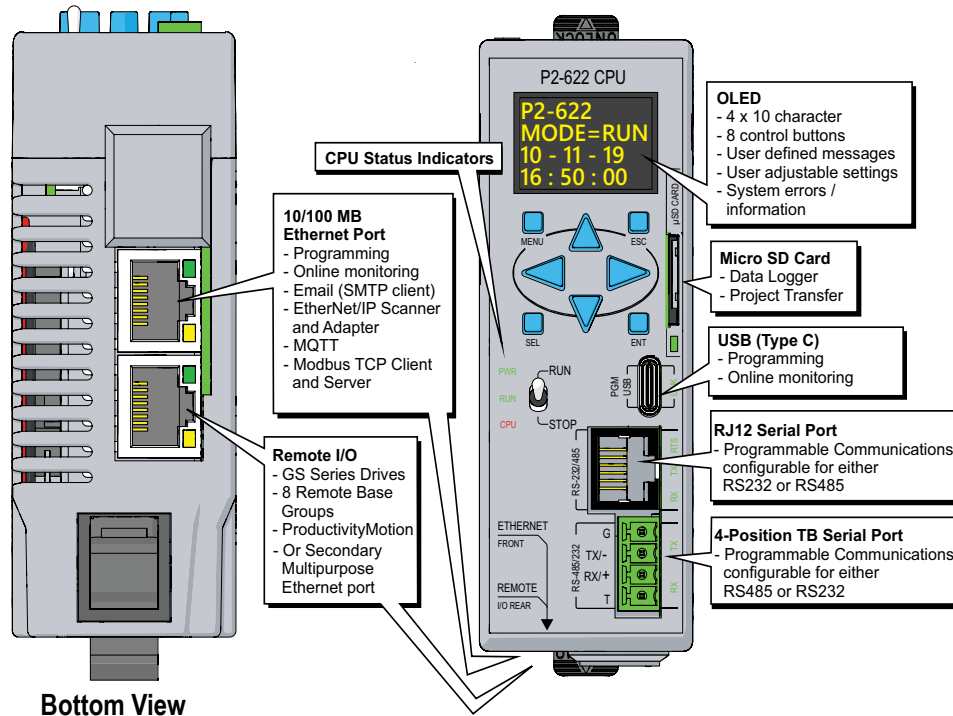

CPU Run/Stop Switch	
RUN position	Executes user program, run-time edits possible
STOP position	Does not execute user program, normal program load position

CPU Status Indicators	
PWR	Green LED is illuminated when power is ON
RUN	Green LED is illuminated when CPU is in RUN mode
CPU	Red LED is illuminated during power ON reset, power down, or watch-dog time-out.

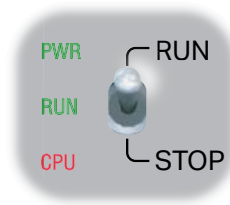

P2-622 CPU Module

CPU Specifications			
User Memory	50MB (Includes program, data and documentation)		
Memory Type	Flash and Battery Backed RAM		
Retentive Memory	512KB		
Scan Time	500µs (3K Boolean, 240 I/O)		
Display	OLED, 4x10 characters, 8 control buttons		
Communications; 5 Integrated Ports	USB IN: Programming, Monitoring, Debug, Firmware ETHERNET: (10/100Mbps Ethernet) Programming, Monitoring, Debug, Firmware, MQTT, Email SMTP Client, Modbus TCP Client (32 Servers) and Server (16 Clients), EtherNet/IP Scanner (32 Adapters) and Adapter (4 scanners) with 8 connections per device. REMOTE I/O: 16 GS-EDRV100 (GS Drives), 8 Remote Base Groups RJ12 RS232/485: Programmable 4 Position TB RS485/232: Programmable (removable terminal block included)		
Data Logging/Project Transfer	microSD card slot		
Hardware Limits of System	9 Base Groups: 1 Local (CPU) + 8 Remote (P2-RS and/or P1-RX) + 4 PS-AMC 4,320 Hardware I/O points (All 32 point modules)		
Instruction Types	<table border="0"> <tr> <td> Application Functions Array Functions Counters/Timers Communications Data Handling Drum Sequencers Math Functions </td> <td> PID Program Control String Functions System Functions Contacts Coils Motion Control </td> </tr> </table>	Application Functions Array Functions Counters/Timers Communications Data Handling Drum Sequencers Math Functions	PID Program Control String Functions System Functions Contacts Coils Motion Control
Application Functions Array Functions Counters/Timers Communications Data Handling Drum Sequencers Math Functions	PID Program Control String Functions System Functions Contacts Coils Motion Control		
Real Time Clock Accuracy	±2s per day typical at 25°C ±10s per day maximum at 60°C		

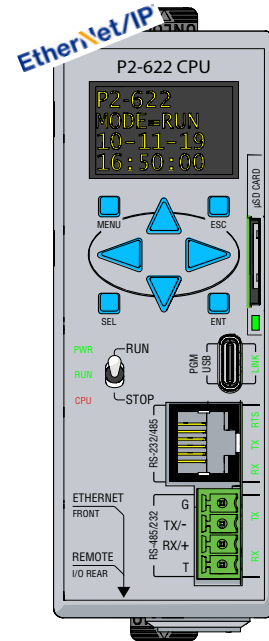

IMPORTANT!



Hot-Swapping Information
NOTE: This device cannot be Hot Swapped.

General Specifications	
Operating Temperature	0° to 60°C (32° to 140°F)
Storage Temperature	-20° to 70°C (-4° to 158°F)
Humidity	5 to 95% (non-condensing)
Environmental Air	No corrosive gases permitted
Vibration	IEC60068-2-6 (Test Fc)
Shock	IEC60068-2-27 (Test Ea)
Heat Dissipation	3.81 W
Enclosure Type	Open equipment
Module Location	Controller slot in the local base in a Productivity®2000 system.
Weight	158g (5.6 oz)
Agency Approvals**	UL508 file E139594, Canada & USA CE (EN61131-2)*

*Meets EMC and Safety requirements. See the Declaration of Conformity for details.

**To obtain the most current agency approval information, see the Agency Approval Checklist section on the specific component part number web page.

P2-622 CPU Module

Port Specifications

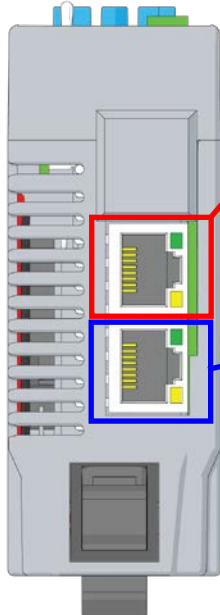

P2-622 Bottom View

Ethernet Port (On bottom of CPU)

RJ-45 style connector used for:

- Connection to a PC running the ProductivitySuite programming software
- Modbus TCP Client (32 Servers) connections (Modbus requests sent from the CPU)
- Modbus TCP Server (16 Clients) connections (Modbus requests received by the CPU)
- EtherNet/IP Scanner (32 Adaptors)
- EtherNet/IP Adapter (4 scanners) with 8 connections per device.
- Outgoing E-mail
- MQTT Client (4 brokers)

Remote I/O Port (RJ-45 style connector on bottom of CPU)

- Connection to a Remote I/O network of devices using the Productivity Remote Protocol, e.g. P2-RS, P1-RX, GS Drives, etc.
- Can be user defined and used as a secondary multipurpose ethernet port with the exception that this port does not have Default Gateway or DNS capability.

Ethernet Specifications		
Port Name	ETHERNET	REMOTE I/O
Description	Standard transformer isolated Ethernet port with built-in surge protection for: <ul style="list-style-type: none"> • programming • online monitoring • firmware • MQTT • Email (SMTP client), • Modbus/TCP client/server connections (fixed IP or DHCP) • Ethernet/IP Scanner/Adapter connections. 	Standard transformer-isolated Ethernet port with built-in surge protection for connection of: <ul style="list-style-type: none"> • ProtosX remote I/O, • P2-RS and P1-RX remote slaves, • GS Drives with optional communication modules, • and/or PS-AMC modules • Can be configured as a Secondary multipurpose Ethernet port
Transfer Rate	RJ45 Yellow LED Off = 10Mbps / On = 100 Mbps	
Port Status LED	RJ45 Green LED Solid when network LINK is established. Flashes when port is active (ACT)).	

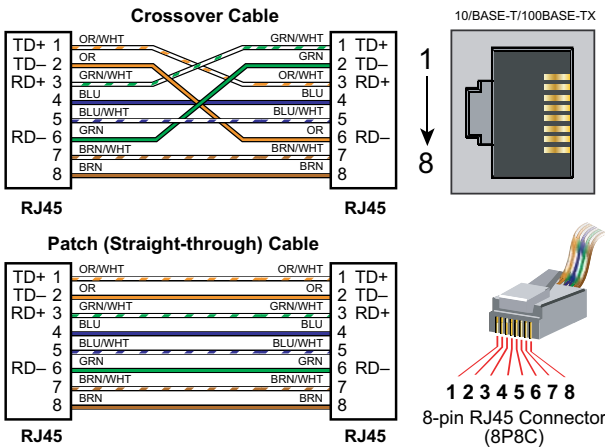

P2-622 CPU Module

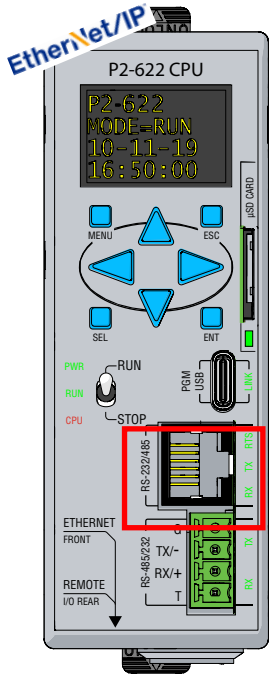

RS-232/485 Port

The P2-622 CPU includes an RJ-12 style connector and a 4-position terminal block connector that may each be programmed for RS232 or RS485 connections. These ports may be used for:

- Modbus RTU Master connections
- Modbus RTU Slave connections
- ASCII full or half duplex communications
- Custom Protocol Incoming and Outgoing communications

RS-232 Specifications

TXD	RS-232 Transmit output
RXD	RS-232 Receive input
RTS	Handshaking output for modem control
GND	Logic ground
Maximum Output Load (TXD/RTS)	3kΩ, 1000 pf
Minimum Output Voltage Swing	±5V
Output Short Circuit Protection	±15mA

RJ12 Connector

Description	Programmable RS232/485 Port
	- Non-isolated RS-232 DTE port connects the CPU as a Modbus/ASCII master or slave to a peripheral device. Includes ESD and built in surge protection - Non-isolated RS-485 port connects the CPU as a Modbus/ASCII master or slave to a peripheral device. Includes ESD/EFT protection and automatic echo cancellation when transmitter is active
Data Rates	Selectable, 1200, 2400, 4800, 9600, 19200, 33600, 38400, 57600, and 115200
+5V Cable Power	210mA maximum at 5V, ±5%. Reverse polarity and overload protected.
Port Status LED	Green LED illuminated when active for TXD, RXD and RTS
Cable Options	EA-MG-PGM-CBL D2-DSCBL USB-RS232 with D2-DSCBL FA-CABKIT FA-ISOCAN for converting RS-232 to isolated RS-485

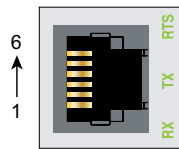

6-pin RJ12 Female Modular Connector

Pin #	RS232	RS485
6	GND	GND
5	RTS	
4	TXD	TXRX-
3	RXD	TXRX+
2	+5V, 210mA	Do no connect
1	GND	GND

P2-622 CPU Module

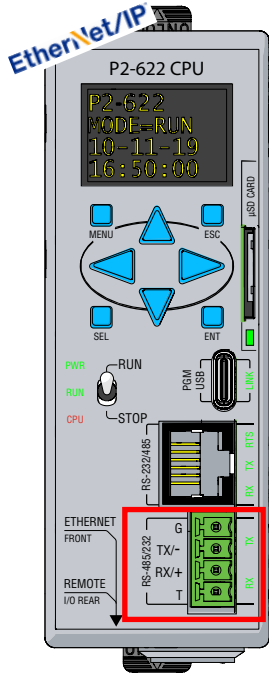

Removable connector included. Spare connectors available (part no. P3-RS485CON).

RS-485/232 Port

A 4-pin removable terminal block used for:

- Modbus RTU Master connections
- Modbus RTU Slave connections
- ASCII Incoming and Outgoing communications
- Custom Protocol Incoming and Outgoing communications

RS-485 Specifications

Description	<p>Programmable RS232/485 Port</p> <ul style="list-style-type: none"> - Non-isolated RS-232 DTE port connects the CPU as a Modbus/ASCII master or slave to a peripheral device. Includes ESD and built in surge protection - Non-isolated RS-485 port connects the CPU as a Modbus/ASCII master or slave to a peripheral device. Includes ESD/EFT protection and automatic echo cancellation when transmitter is active
Data Rates	Selectable, 1200, 2400, 4800, 9600, 19200, 33600, 38400, 57600, and 115200
+5V Cable Power	210mA maximum at 5V, ±5%. Reverse polarity and overload protected
Port Status LED	Green LEDs illuminated when active for TXD, RXD and RTS
Cable Options	<ul style="list-style-type: none"> EA-MG-PGM-CBL D2-DSCBL USB-RS232 with D2-DSCBL FA-CABKIT FA-ISOCAN for converting RS-232 to isolated RS-485

4 Position Terminal Block

4 Position Terminal Block	
Description	<p>Programmable RS232/485 Port</p> <ul style="list-style-type: none"> - Non-isolated RS-232 DTE port connects the CPU as a Modbus/ASCII master or slave to a peripheral device. Includes ESD and built in surge protection - Non-isolated RS-485 port connects the CPU as a Modbus/ASCII master or slave to a peripheral device. Includes ESD/EFT protection and automatic echo cancellation when transmitter is active
Data Rates	Selectable, 1200, 2400, 4800, 9600, 19200, 33600, 38400, 57600, and 115200
Port Status LED	Green LED illuminated when active for TXD and RXD
Cable Options	Go to AutomationDirect.com for RS-232 and RS-485 cables

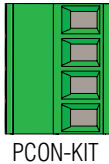
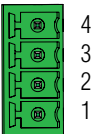

Pin #	RS232	RS485
4	GND	GND
3	TXD	TXRX-
2	RXD	TXRX+
1	Do not connect	TERMINATE

P2-622 CPU Module

Port Specifications

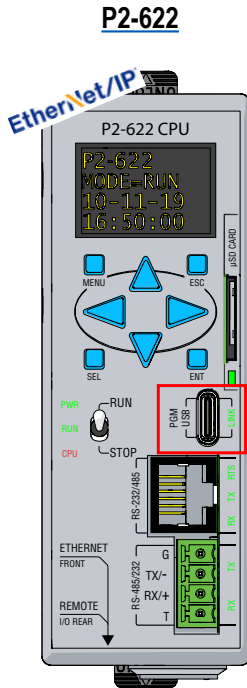

USB C Port

Used exclusively for connecting to a PC running the Productivity Suite programming software.

USB C Specifications	
Port Name	PGM USB
Description	Standard USB C Slave input for programming and online monitoring, with built-in surge protection. Not compatible with older full speed USB devices.
Transfer Rate	480 Mbps
Port Status LED	Green LED is illuminated when LINK is established when programming software.
Cables	USB Type A to USB Type C: 6ft cable part # USB-CBL-AC6

OLED Message Display

The P2-622 CPU incorporates a 4-line by 10-character OLED (Organic Light-Emitting Diode) display for system alarms, information and for displaying user-defined messages. Control buttons located beneath the OLED display allow the user to navigate through menu items. These buttons also permit local configuration of time and date settings.

User defined display messages may be configured using the Productivity Suite Programming Software. A "Display Page" dialog box allows the user to program text into user-defined tags that will be displayed based on the programmed ladder execution.

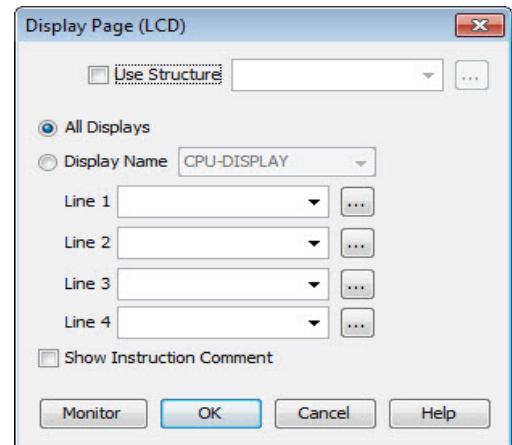
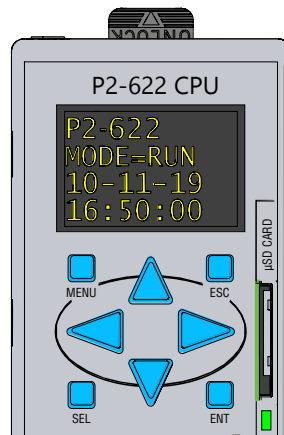

OLED Control Buttons	
Menu Button	Access the OLED menu
ESC Button	Returns to the previous screen
SEL Button	Selects the desired menu option
ENT Button	Starts the selected process
Directional Arrows	Moves the cursor around the 4 Row x 10 Column OLED

P2-622 CPU Module

CPU Installation

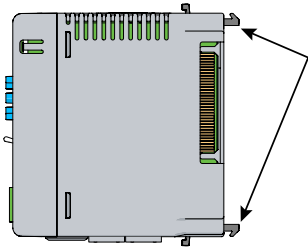

Step One:
Unlock both locking tabs

WARNING: Do not apply field power until the following steps are completed. .

Step Two:
Seat CPU on support platform and push towards base until circuit board is fully engaged into connector

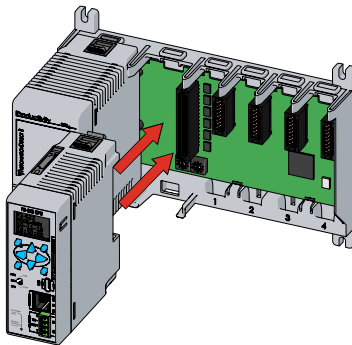

Step Three:
Snap retaining tab into the locked position.

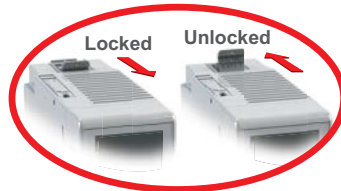

WARNING: Explosion hazard – Do not connect or disconnect or operate switches while circuit is live unless the area is known to be non-hazardous. Do not hot-swap modules unless the area is known to be non-hazardous.