



Pneumatic Push-to-Connect Fittings

NITRA pneumatic push-to-connect fitting bodies are made of a strong thermoplastic (PBT) and have stainless steel tube gripping claws. Threaded components are made of nickel-plated brass and have pre-applied Teflon thread sealant (O-ring on #10-32, M5 and G threads). The bodies of elbow and tee fittings with threaded connections can be rotated after installation to allow for variations in piping direction. NITRA Polyurethane and Nylon 12 tubing is easily connected by simply inserting the tubing end into the fitting. To release the tubing, press the circular release ring and the tubing can be easily pulled out.

Features

- Large selection of fitting configurations
- Inch and metric sizes available
- NPT, BSPT (R), and BSPP (G) threads available
- Tough thermoplastic bodies, stainless steel tube gripping claws, nickel-plated threads with pre-applied Teflon sealant (O-ring on #10-32, M5 and G threads)
- Threaded Elbow and Tee bodies can be rotated after installation
- Release rings are color coded to differentiate between inch and metric sizes
- For use with air only
- Working pressure: -29.5" Hg to 150 psi.
- Working temperature: 32 to 140°F (0 to 60°C)



*Tapered Thread Fitting
Cut-away Diagram*

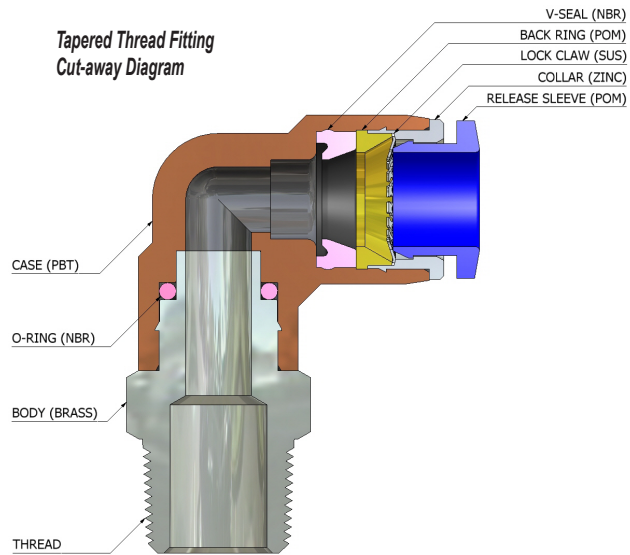

*Parallel Thread Fitting
Cut-away Diagram*

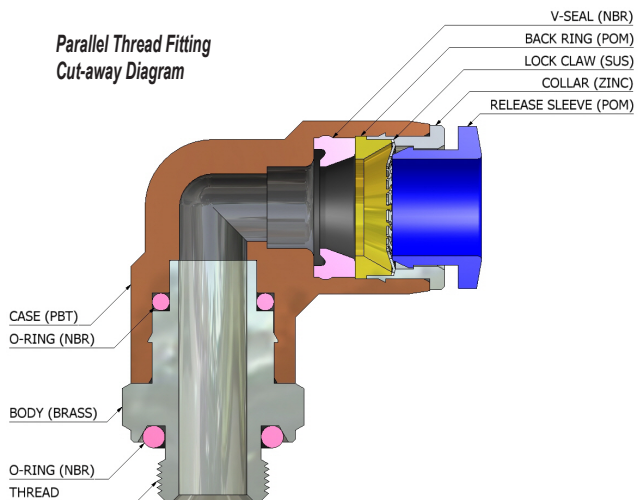



Pneumatic Push-to-Connect Fittings

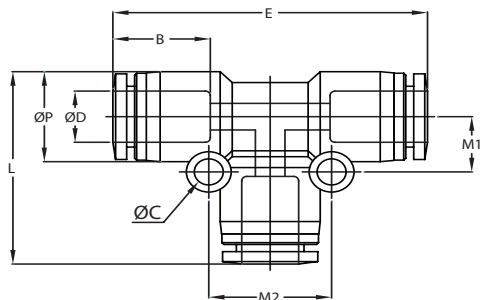

NITRA pneumatic push-to-connect union tee fitting with thermoplastic (PBT) body and stainless steel tube gripping claws. For use with polyurethane or nylon tubing. Five fittings per package.



Inch Fitting



Metric Fitting

NITRA Union Tee													
Inch Sizes - dimensions in inches (in.)													
Part No.	Price	Size	ØD	ØP	L	E	ØC	B	M1	M2	Orifice	Package Weight (lbs)	Qty. per pack
UT18	\$18.00	1/8 in.	1/8	0.30	0.53	0.53	0.13	0.44	0.21	0.42	0.09	0.1	5
UT532*	\$13.00	5/32 in. (4 mm)	5/32	0.41	0.94	1.43	0.13	0.59	0.25	0.50	0.12	0.1	5
UT14	\$13.50	1/4 in.	1/4	0.51	1.09	1.68	0.14	0.66	0.32	0.65	0.19	0.2	5
UT38	\$15.00	3/8 in.	3/8	0.69	1.35	2.02	0.18	0.79	0.43	0.87	0.31	0.4	5
UT12	\$21.00	1/2 in.	1/2	0.83	1.60	2.38	0.18	0.90	0.50	1.00	0.35	0.4	5
Metric Sizes - dimensions in millimeters (mm)													
UT6M	\$13.00	6 mm	6	12.5	27.3	41.5	3.3	16.4	7.7	15.4	5.0	0.2	5
UT8M	\$14.00	8 mm (5/16 in.)	8	14.5	31.0	45.6	4.3	18.7	8.9	17.8	6.5	0.2	5
UT10M	\$15.50	10 mm	10	17.5	34.1	48.4	4.3	20.1	9.8	19.7	8.0	0.4	5
UT12M	\$20.50	12 mm	12	20.5	40.1	57.3	4.3	22.8	13.2	26.3	10.0	0.4	5
UT16M	\$30.50	16 mm	16	25.5	47.0	68.6	5.3	24.1	15.9	31.8	13.0	0.4	5

* UT532 has blue release rings

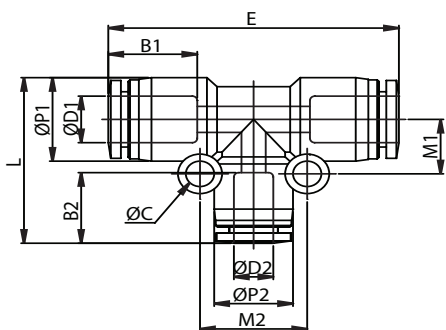

NITRA pneumatic push-to-connect union tee reducer fitting with thermoplastic (PBT) body and stainless steel tube gripping claws. For use with polyurethane or nylon tubing. Five fittings per package.



Inch Fitting



Metric Fitting

NITRA Union Tee Reducer																
Inch Sizes - dimensions in inches (in.)																
Part No.	Price	Size	ØD1	ØD2	ØP1	ØP2	L	E	ØC	B1	B2	M1	M2	Orifice	Package Weight (lbs)	Qty. per pack
UTR14-532	\$13.00	1/4 in. x 5/32 in. (4 mm)	1/4	5/32	0.51	0.41	1.04	1.60	0.17	0.66	0.59	0.32	0.57	0.13	0.2	5
UTR516-14	\$13.50	5/16 in. x 1/4 in.	5/16	1/4	0.57	0.51	0.89	0.89	0.18	0.72	0.66	0.38	0.69	0.20	0.2	5
UTR38-14	\$15.50	3/8 in. x 1/4 in.	3/8	1/4	0.69	0.51	1.26	1.90	0.18	0.79	0.66	0.43	0.69	0.20	0.3	5
UTR38-516	\$14.50	3/8 in. x 5/16 in.	3/8	5/16	0.69	0.57	0.98	0.97	0.17	0.79	0.72	0.43	0.74	0.26	0.4	5
UTR12-38	\$21.50	1/2 in. x 3/8 in.	1/2	3/8	0.83	0.69	1.44	2.30	0.18	0.90	0.79	0.50	0.87	0.31	0.4	5
Metric Sizes - dimensions in millimeters (mm)																
UTR6M-4M	\$13.50	6 mm x 4 mm (5/32 in.)	6	4	12.5	10.4	25.4	41.6	3.3	16.4	14.9	7.9	13.8	3.0	0.2	5
UTR8M-6M	\$15.00	8 mm (5/16 in.) x 6 mm	8	6	14.8	12.5	29.3	46.1	4.5	18.7	16.4	9.6	17.0	5.0	0.4	5
UTR10M-8M	\$17.00	10 mm x 8 mm (5/16 in.)	10	8	17.5	14.5	33.9	49.4	4.3	20.1	18.7	10.9	18.8	6.5	0.4	5
UTR12M-10M	\$22.50	12 mm x 10 mm	12	10	20.5	17.5	37.6	56.1	4.3	22.8	20.1	12.4	21.9	8.0	0.4	5
UTR16M-10M	\$30.00	16 mm x 10 mm	16	10	25.5	17.5	42.8	61.6	5.3	24.1	20.1	15.9	22.8	8.0	0.4	5
UTR16M-12M	\$30.50	16 mm x 12 mm	16	12	25.5	20.5	45.3	64.6	5.3	24.1	22.8	15.9	25.8	10.0	0.4	5



Pneumatic Fitting Instructions and Caution Information

Assembly Instructions

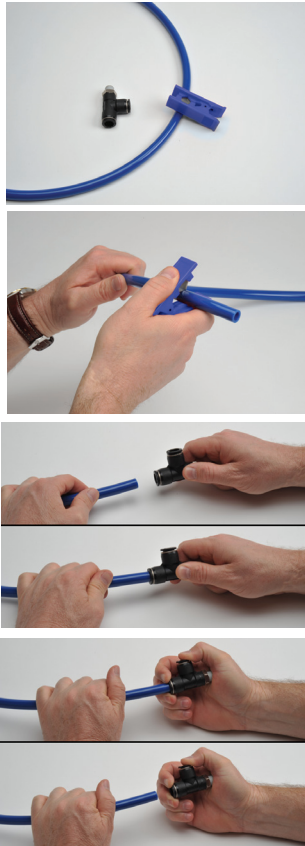

Prepare the **NITRA** tubing for cutting and make sure to have the proper tubing cutters like the **NITRA** TC-12 or TC-20.

(If cutting bonded tubing, carefully split the tubes with a knife and then pull apart as needed.)

Cut the **NITRA** tubing at a right angle with the axis using a standard tube cutter. After cutting the tubing, make sure to check the cut end for an even cut with no debris.

Insertion of the **NITRA** tubing into fittings

- Make sure the tube is inserted fully into the fitting.
- Pull the tube gently to make sure it does not release.
- If the tube end is damaged or deformed, leakage or unexpected tube release may occur. Make sure to check tubing end thoroughly.

Removing the **NITRA** tubing from fittings

- Make sure the pressure in the tube is zero before releasing the tube from the fittings.
- To release the tubing, press the release ring at the end of the fitting and pull the tube with one hand.
- Inspect the released tube end and make a clean cut if it is damaged or deformed.

Common Precautions for Tubing and Fitting Products

Warnings:

- Do not use fittings with media other than air.
- Avoid installing with tubing under tension or with excessive bends.
- Do not use the product where weld spatters occur as fire may occur.
- Product damage or air leakage may occur at places where there is excessive rotation or vibration of the fittings.
- Use caution in water as the product may be damaged by surge pressure.
- Do not use the product where it is directly exposed to fluids such as cutting oil, lubricating oil, and coolant oil.

Cautions:

- Assemble the tubing only after cleaning away impurities such as dust and excess debris.
- Fitting products are recommended for air systems only. Avoid using for other purposes.
- When using tubing other than **NITRA** brand with **NITRA** fittings, be sure the tubing OD conforms to the tolerances in Table 1 below.

Table 1 - Tolerance of the Outer Diameter of the Tube

Tube Specifications	ø5/32 [ø4]	ø1/4 [ø6]	ø5/16 [ø8]	ø3/8 [ø10]	ø1/2 [ø12]
Permissible tolerance	+ 0.005 [+/- 0.13]				

Pneumatic Tubing Cutter

Part Number	Description	Pcs/Pkg	Wt (lb)	Price
<u>TC-12</u>	NITRA pneumatic tubing cutter for use with 1/8 to 1/2 inch and 4 to 12 mm outside diameter flexible plastic tubing.	1	0.1	\$5.75
<u>TC-20</u>	NITRA pneumatic heavy duty tubing cutter for use with polyurethane, nylon and other flexible tubing up to 2 inch [50mm] outside diameter.	1	0.2	\$12.00



[TC-12](#)



[TC-20](#)