



# Process Pipeline Solenoid Valves

## DVP-2C & DVP-3C Series



Part No. **DVP-2CC1C-24A**

The NITRA™ DVP-2C and DVP-3C Series valves can be stacked into a multiple output bank of solenoid valves. The DVP-2C and 3C valves feature a fully encapsulated coil, spring compensated plunger seats for long life, and a miniature stackable composite valve body. The advantage to this design

is the versatility to stock single units and build, mix, and match to meet specifications. In most cases these valves reduce inventory costs and lower installation costs over a conventional manifold valve series. The coils are available with DIN connectors installed.

### Features

- 2-way and 3-way stackable poppet style valves
- 1/8" FNPT ports
- 2-position, normally closed, spring return
- 24VDC, 24VAC or 120VAC solenoids
- DIN style wiring connector

### Valve Symbols



2-way, 2-pos, NC



3-way, 2-pos, NC



See [www.AutomationDirect.com](http://www.AutomationDirect.com)  
for a wide variety of fitting and cable options

### DVP-2C & DVP-3C Series Solenoid Valve Specifications

Model	DVP-2CC1C-24D	DVP-2CC1C-24A	DVP-2CC1C-120A	DVP-3CC1C-24D	DVP-3CC1C-24A	DVP-3CC1C-120A
Price	\$28.00	\$28.00	\$28.00	\$28.00	\$28.00	\$28.00
Weight (lbs)	0.3	0.3	0.3	0.3	0.3	0.3
Valve Type	2-way, 2-position			3-way, 2-position		
Acting	Stackable poppet valve, normally closed, spring return					
Port Size	1/8" FNPT					
Orifice Size	0.6" [1.5 mm]					
CV	0.08			0.08 (exhaust 0.08)		
Media	Air, oil, inert gas, water, caustics*					
Pressure Range	0–200 psi [0–13.8 bar]			1–150 psi [0–10.3 bar]		
Voltage (± 10%)	24VDC	24VAC 50/60 Hz	120VAC 50/60 Hz	24VDC	24VAC 50/60 Hz	120VAC 50/60 Hz
Inrush AC	–	10VA		–	10VA	
Power Consumption	6.5 W	8.5 VA		6.5 W	8.5 VA	
Max Freq	71.4 Hz					
Insulation	Class F (continuous duty)					
Min Response	12–14 ms complete cycle					
Temperature	14°F to 122°F [-10°C to 50°C]					
Lubrication	Not required					
Protection	NEMA Type 4					
Connection	11mm DIN terminal					
Construction	Glass filled nylon body; Viton seals; Operator Brass					
Life Cycle	20 million					
Agency Approvals	CE					

\* Check the chemical compatibility of the valve materials with the process media being used.



# Process Pipeline Solenoid Valves

## DVP-2C & DVP-3C Series

### Dimensions

inches [mm]

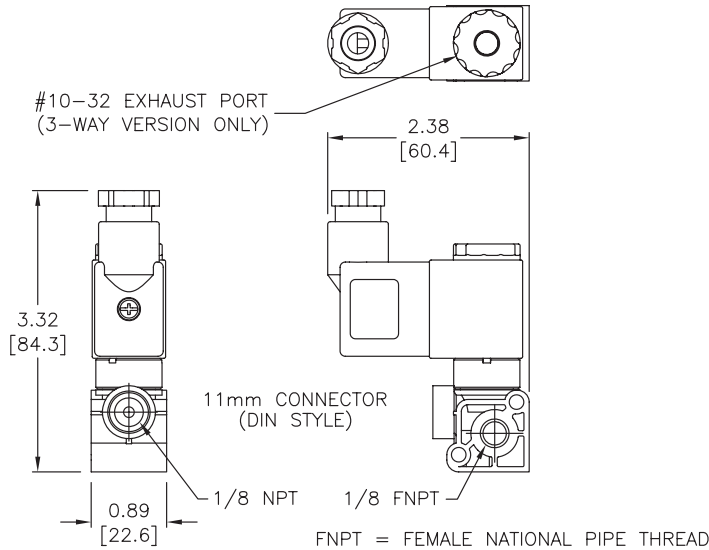

See our website [www.AutomationDirect.com](http://www.AutomationDirect.com) for complete Engineering drawings.

### Accessories

DVP-2C & DVP-3C Series Solenoid Valve Accessories			
Part No.	Description	Price	Weight (lbs)
<b><i>DVP-2BKT</i></b>	Mounting kit for DVP-2C & 3C series valves, 2 station. Includes (2) #8-32 x 2 inch screws, (2) #8 lock nuts and (1) Viton o-ring.	\$5.50	0.1
<b><i>DVP-3BKT</i></b>	Mounting kit for DVP-2C & 3C series valves, 3 station. Includes (2) #8-32 x 3 inch screws, (2) #8 lock nuts and (2) Viton o-rings.	\$7.50	0.1
<b><i>DVP-4BKT</i></b>	Mounting kit for DVP-2C & 3C series valves, 4 station. Includes (2) #8-32 x 4 inch screws, (2) #8 lock nuts and (3) Viton o-rings.	\$9.00	0.1
<b><i>DVP-5BKT</i></b>	Mounting kit for DVP-2C & 3C series valves, 5 station. Includes (2) #8-32 x 5 inch screws, (2) #8 lock nuts and (4) Viton o-rings.	\$11.00	0.1
<b><i>DVP-6BKT</i></b>	Mounting kit for DVP-2C & 3C series valves, 6 station. Includes (2) #8-32 x 6 inch screws, (2) #8 lock nuts and (5) Viton o-rings.	\$13.50	0.1

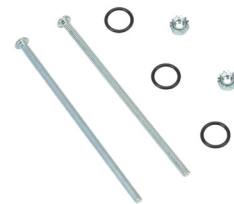

Part No. DVP-4BKT

# Solenoid Valve Cables and Connectors



These high quality connectors and over-molded cables help reduce wiring time. The lower voltage models, 24V or 110V AC/DC, include built-in surge suppression, Yellow LED indicator and are rated for connecting with electronics. The 230V AC/DC models are rated for straight wired products. All models are available in five sizes based on DIN 43650.

## Features

- 8mm, 9.4mm, 10mm, 11mm and 18mm square DIN styles
- Fits most popular solenoid valves and sensors
- Suppression and LED indication available in 24V or 110V AC/DC models
- PVC jacketed cables in 1, 3 or 5 meter lengths on select connectors
- Field wireable connectors on select models
- Polarity insensitive (follow solenoid, sensor, or other devices wiring diagram)



### 8mm Connectors

Dimensions shown  
mm [inches]

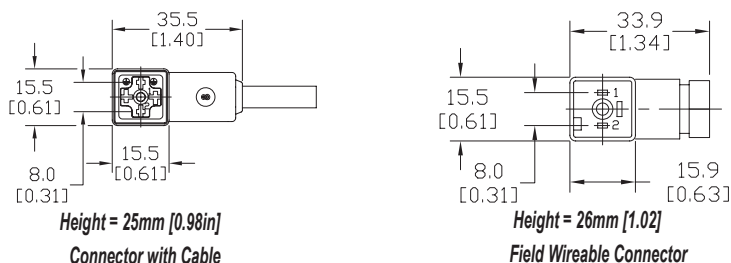
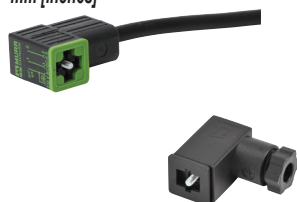

8mm (3-pole) Connectors (per DIN 43650 Form C)												
Part No.	Price	Voltage (AC/DC)	Current Rating	IP Rating	Wire Size	Cable Dia. (in.)	LED	Surge Protection	Wiring Figure	Screw Size/Torque	Weight (lbs)	Agency Approval
SC8-LS24-3	\$15.50	24 ±20%	max 4A	67	18 AWG	0.23	yes	zener diode (D-Z DO-15 47V 2W)	1	m2.5-0.45x25mm/ 0.4 Nm (3.5 in lb)	0.40	CSA (080128-0-000)
SC8-LS24-5	\$18.50										0.65	
SC8-LS110-3	\$19.00	110 ±10%	max 4A	67	18 AWG	0.23	yes	zener diode (D-Z DO-41 ZY200 2W)	7	m2.5-0.45x25mm/ 0.5 Nm (4.4 in lb)	0.41	
SC8-LS110-5	\$22.00										0.63	
SC8-3	\$12.50	230	max 6A	65	Solid 12 AWG Stranded 14 AWG w/Ferrule 16 AWG	field wireable gland size 0.20 to 0.24	no	none	9	m2.5-0.45x25mm/ 0.5 Nm (4.4 in lb)	0.39	none
SC8-0	\$8.25										0.10	
SC8-1	\$16.50										0.10	
SC8-5	\$17.50										0.68	

Last digit in part number denotes cable length in meters, a 0 indicates field termination.

### 8mm Transmitter Connector

Dimensions shown  
mm [inches]

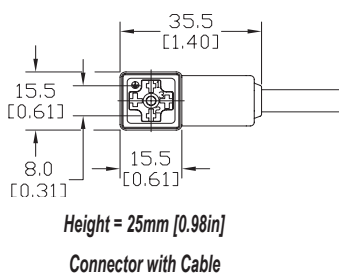

8mm (4-pole) Connectors (per DIN 43650 Form C)												
Part No.	Price	Voltage (AC/DC)	Current Rating	IP Rating	Wire Size	Cable Dia. (in.)	LED	Surge Protection	Wiring Figure	Screw Size/Torque	Weight (lbs)	Agency Approval
SC8-5T	\$23.50	230	max 6A	67	18 AWG	0.26	yes	none	8	m3-0.5x42mm/ 0.5 Nm (4.4 in lb)	0.80	CSA (080128-0-000)

Last numeric digit in part number denotes cable length in meters, a 0 indicates field termination.

# Solenoid Valve Cables and Connectors

## 9.4mm Connectors

Dimensions shown  
mm [inches]

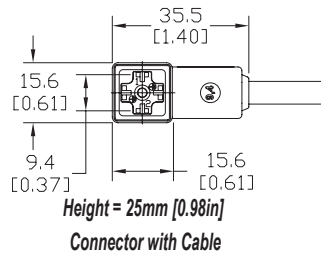

9.4mm (3-pole) Connectors (DIN Style, Form C Industrial)												
Part No.	Price	Voltage (AC/DC)	Current Rating	IP Rating	Wire Size	Cable Dia. (in.)	LED	Surge Protection	Wiring Figure	Screw Size/Torque	Weight (lbs)	Agency Approval
<a href="#">SC9-LS24-3</a>	\$15.50	24 ±20%	max 4A	67	18 AWG	0.23	yes	zener diode (D-Z DO-15 47V 2W)	1	m3-0.5x26mm/ 0.4 Nm (3.5 in lb)	0.40	CSA (080128-0-000)
<a href="#">SC9-LS24-5</a>	\$18.50								7		0.64	
<a href="#">SC9-LS110-3</a>	\$19.00	110 ±10%	max 6A	67	18 AWG	no	none	2	m3-0.5x26mm/ 0.5 Nm (4.4 in lb)	0.40	none	
<a href="#">SC9-LS110-5</a>	\$22.00							7		0.64		
<a href="#">SC9-3</a>	\$12.50	230	max 6A	67	18 AWG	no	none	2	m3-0.5x26mm/ 0.5 Nm (4.4 in lb)	0.40	none	
<a href="#">SC9-5</a>	\$17.50							7		0.64		

## 9.4mm Connectors

Dimensions shown  
mm [inches]

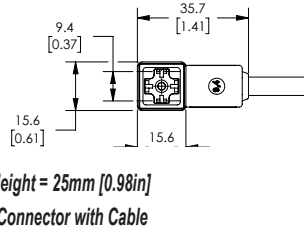

9.4mm (4-pole) Connectors (DIN Style, Form C Industrial)													
Part No.	Price	Voltage (AC/DC)	Current Rating	IP Rating	Wire Size	Cable Dia.	Cable Length	LED	Surge Protection	Wiring Figure	Screw Size/Torque	Weight (lbs)	Agency Approval
<a href="#">7000-94141-6270300</a>	\$18.00	230 VAC/ VDC	max 6A	IP67	18 AWG	5.6-6.2 mm	9.8ft/3m	no	none	8	m3-0.5x26mm/ 0.4 Nm (3.5 in lb)	0.50	CSA (080128-0-000)/ RoHS
<a href="#">7000-94141-6270500</a>	\$24.00						16.4ft/5m					0.79	

# Solenoid Valve Cables and Connectors

## 10mm Connectors

Dimensions shown  
mm [inches]

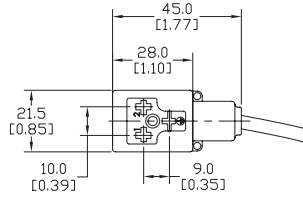

Height = 30mm [1.18in]

Connector with Cable

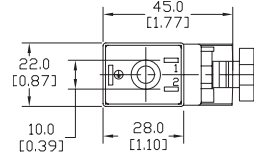

Height = 41mm [1.61in]

Field Wireable Connector

### 10mm (3-pole) Connectors (per DIN 43650 Form B)

Part No.	Price	Voltage (AC/DC)	Current Rating	IP Rating	Wire Size	Cable Dia. (in.)	LED	Surge Protection	Wiring Figure	Screw Size/Torque	Weight (lbs)	Agency Approval			
<a href="#">SC10-LS24-3</a>	\$15.50	24 ±20%	max 4A	67	18 AWG	0.23	yes	zener diode (D-Z DO-15 47V 2W)	10	m3-0.5x30mm/ 0.4 Nm (3.5 in lb)	0.43	CSA (080128-0-000)			
<a href="#">SC10-LS24-5</a>	\$18.50										0.68				
<a href="#">SC10-LS110-3</a>	\$19.00	110 ±10%	max 1A				no	none	3	zener diode (D-Z DO-41 ZY200 2W)	6		0.43		
<a href="#">SC10-LS110-5</a>	\$22.00													0.68	
<a href="#">SC10-3</a>	\$12.50	230	max 10A				no	none	3	zener diode (D-Z DO-15 47V 2W)	4		m3-0.5x42mm/ 0.5 Nm (4.4 in lb)	0.43	none
<a href="#">SC10-5</a>	\$17.50													0.68	
<a href="#">SC10-LS24-0</a>	\$12.50	24 ±20%	max 4A	65	Solid 12 AWG Stranded 14 AWG w/Ferrule 16 AWG	field wireable gland size 0.24 to 0.32	yes	zener diode (D-Z DO-15 47V 2W)	4	m3-0.5x42mm/ 0.5 Nm (4.4 in lb)	0.07	none			
<a href="#">SC10-LS110-0</a>	\$14.00	110 ±10%	max 1A								mov (SIOV S10 K130)		5	0.07	

Last digit in part number denotes cable length in meters, a 0 indicates field termination.

## 11mm Connectors

Dimensions shown  
mm [inches]

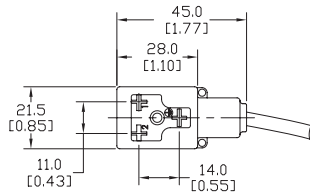

Height = 30mm [1.18in]

Connector with Cable

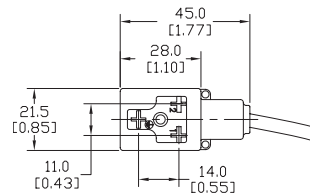

Height = 30mm [1.18in]

Reverse Connector with Cable

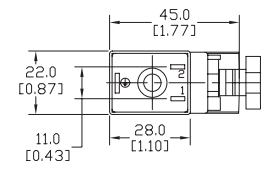

Height = 41mm [1.61in]

Field Wireable Connector

### 11mm (3-pole) Connectors (DIN Style, Form B Industrial)

Part No.	Price	Voltage (AC/DC)	Current Rating	IP Rating	Wire Size	Cable Dia. (in.)	LED	Surge Protection	Wiring Figure	Screw Size/Torque	Weight (lbs)	Agency Approval	
<a href="#">SC11-LS24-3</a>	\$15.50	24 ±20%	max 4A	67	18 AWG	0.23	yes	zener diode (D-Z DO-15 47V 2W)	10	m3-0.5x30mm/ 0.4 Nm (3.5 in lb)	0.44	CSA (080128-0-000)	
<a href="#">SC11-LS24-5</a>	\$18.50										0.67		
<a href="#">SC11-LS110-3</a>	\$19.00	110 ±10%	max 1A				no	zener diode (D-Z DO-41 ZY200 2W)	6	zener diode (D-Z DO-15 47V 2W)	10		0.44
<a href="#">SC11-LS110-5</a>	\$22.00												
<a href="#">SC11-LS24-3R</a>	\$15.50	24 ±20%	max 4A				no	zener diode (D-Z DO-41 ZY200 2W)	6	zener diode (D-Z DO-15 47V 2W)	10		0.44
<a href="#">SC11-LS24-5R</a>	\$18.50												
<a href="#">SC11-LS110-3R</a>	\$19.00	110 ±10%	max 1A	no	zener diode (D-Z DO-41 ZY200 2W)	6	zener diode (D-Z DO-15 47V 2W)	6	0.44				
<a href="#">SC11-LS110-5R</a>	\$22.00									0.67			
<a href="#">SC11-3</a>	\$12.50	230	max 10A	no	none	3	zener diode (D-Z DO-15 47V 2W)	4	m3-0.5x42mm/ 0.5 Nm (4.4 in lb)	0.44	none		
<a href="#">SC11-5</a>	\$17.50									0.67			
<a href="#">SC11-LS24-0</a>	\$12.50	24 ±20%	max 4A	65	Solid 12 AWG Stranded 14 AWG w/Ferrule 16 AWG	field wireable gland size 0.24 to 0.32	yes	zener diode (D-Z DO-15 47V 2W)	4	m3-0.5x42mm/ 0.5 Nm (4.4 in lb)	0.07	none	
<a href="#">SC11-LS110-0</a>	\$14.00	110 ±10%	max 1A								mov (SIOV S10 K130)		5
<a href="#">SC11-0</a>	\$10.50	230	max 10A	no	none	9	0.07						

Last numeric digit in part number denotes cable length in meters, a 0 indicates field termination.

# Solenoid Valve Cables and Connectors Wiring Diagrams

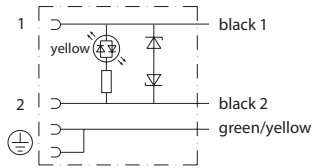

**Figure No. 1**

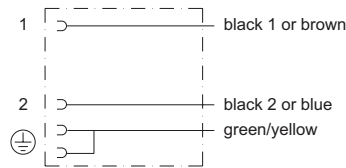

**Figure No. 2**

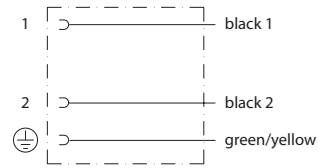

**Figure No. 3**

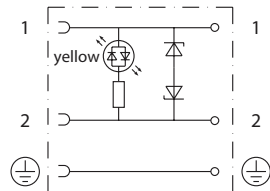

**Figure No. 4**

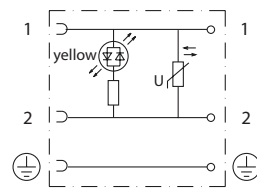

**Figure No. 5**

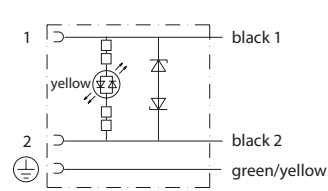

**Figure No. 6**

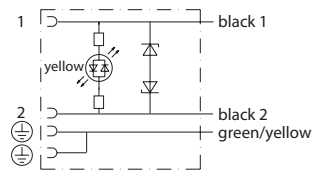

**Figure No. 7**

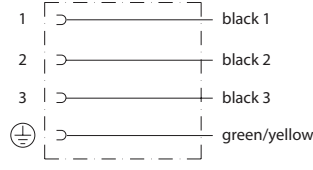

**Figure No. 8**

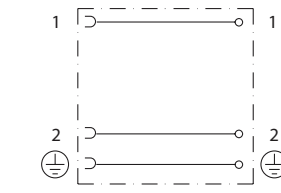

**Figure No. 9**

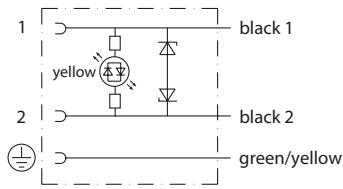

**Figure No. 10**