

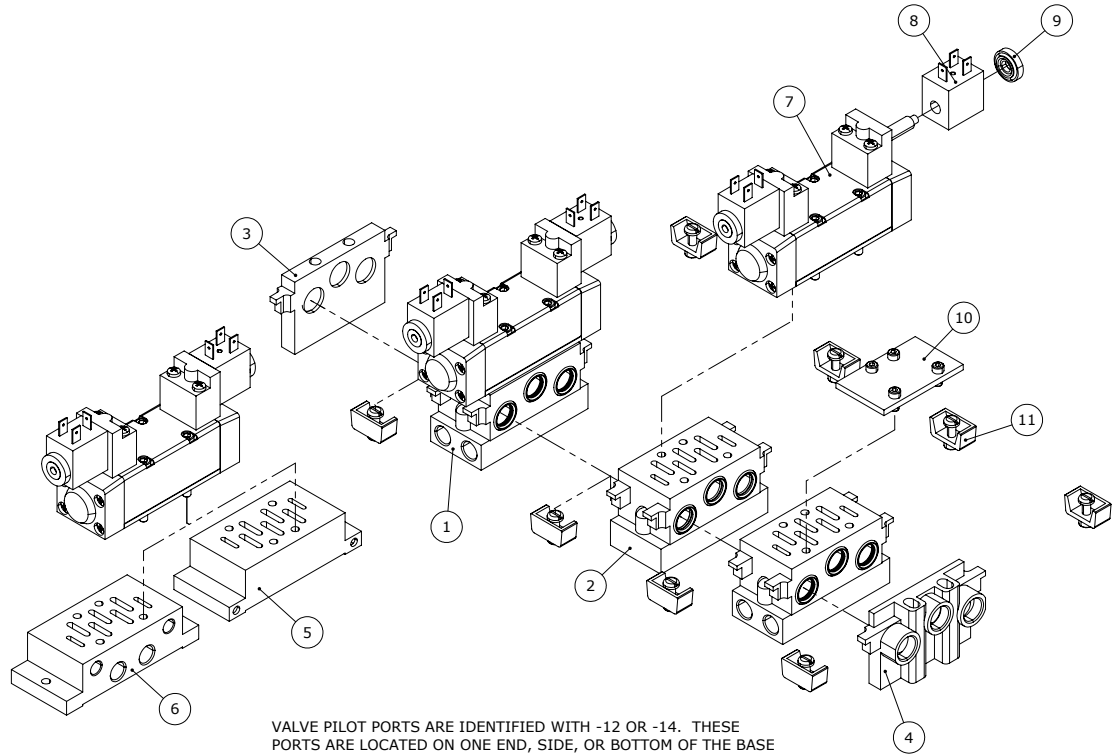

ISO 5599 Solenoid Valves, Bases, Manifolds and Accessories

NITRA ISO 5599 valves and other components are a robust directional control solution that conforms to ISO 5599/1 standard. Components are available in size 1 or size 2 to deliver excellent performance for many industrial pneumatic systems. Valves and bases are interchangeable with other 5599/1 systems from other manufacturers. Bases and manifolds are available in either G-thread (BSPP) or NPT.

ISO 5599 Manifolds/ Bases/Valves	
1	Manifold Side Orientation
2	Manifold Bottom Orientation
3	Manifold Blind End Plate
4	Manifold Inlet
5	Stand Alone Base Bottom Orientation
6	Stand Alone Base Side Orientation
7	Solenoid Valve
8	Solenoid Coil
9	Coil Nut
10	Manifold Blank Plate
11	Manifold Attaching Kit



NITRA ISO 5599 manifold components are easily assembled to meet your needs:

- Determine if bottom or side ports are needed.
- Join manifold sections with included clamps.
- Add inlet plate(s) and blind end plate (if needed).
- Install valves on the manifold sections. Blanking plates are available for unused stations.
- Install solenoid coils in desired voltage.
- Connect solenoids to control system and plumb as required.

TO OPERATE THE VALVE AT AN OPERATING PRESSURE (PORT 1) BELOW THE MINIMUM PILOT PRESSURE, REMOVE THE PILOT VALVE AND REVERSE THE PILOT GASKET.

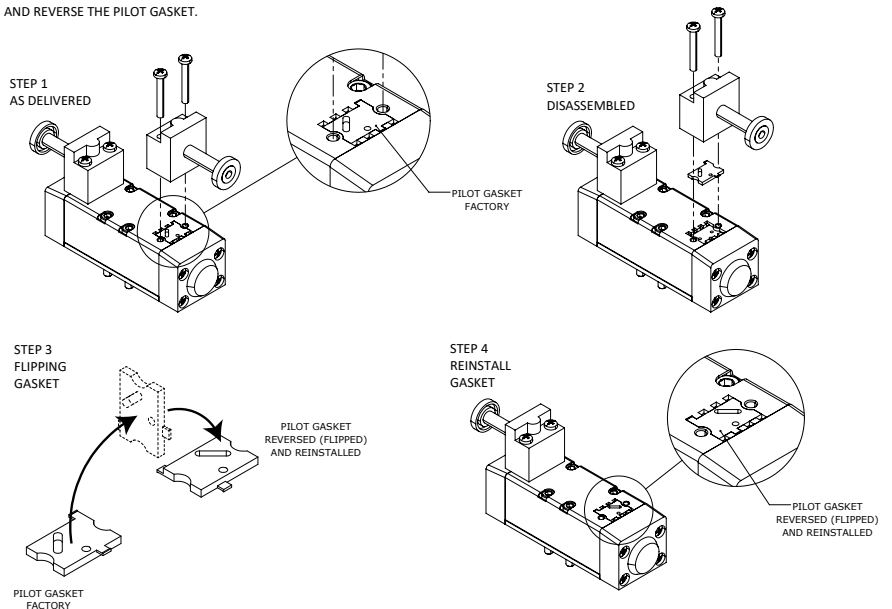



ISO 5599 Solenoid Valves

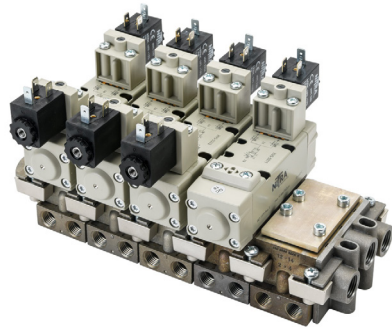

Assembly examples show assembled ISO 5599 valves, bases and manifolds. (each sold separately)

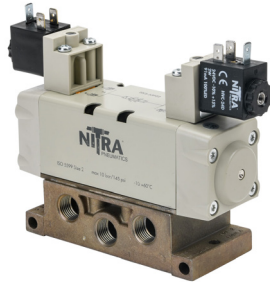

Features

- ISO 5599/1 sizes 1 and 2 interchange with all other brands meeting ISO 5599/1
- 5-port / 2-position and 5/port / 3-position valves available
- Order stand-alone bases or manifolds separately
- Solenoid coils sold separately in 12 & 24 VDC and 24, 110 & 220 VAC



See www.AutomationDirect.com for a wide variety of fitting and cable options



ISO 5599 Solenoid Valves										
Model	HVS-5211	HVS-5212	HVS-53C12	HVS-53E12	HVS-53P12	HVS-5221	HVS-5222	HVS-53C22	HVS-53E22	HVS-53P22
Price	\$86.00	\$112.00	\$134.00	\$134.00	\$134.00	\$132.00	\$155.00	\$163.00	\$163.00	\$163.00
Drawing	PDF	PDF	PDF	PDF	PDF	PDF	PDF	PDF	PDF	PDF
Diagram	A	B	C	D	E	A	B	C	D	E
Weight (lbs.)	0.76	0.86	0.82	0.82	0.82	1.58	1.63	1.59	1.59	1.59
Fluid	Filtered air without lubrication; lubrication, if used, must be continuous									
ISO Size	1					2				
Operating Pressure	Vacuum to 10 bar (vacuum to 145 psi)									
Min. Pilot Pressure	2.5 bar (36 psi)	1 bar (15 psi)				2.5 bar (36 psi)	1 bar (15 psi)			
Operating Temp. Range	-10 to 60°C (14 to 140°F)									
Nominal Diameter	7.5 mm					12mm				
Sonic Conductance (C)	250 NI/min • bar (36.5 scfm/psi)					657.14 NI/min • bar (95.9 scfm/psi)				
Critical Pressure Ratio (b)	0.36					0.25				
Flow Rate at 6 bar @ delta-P 0.5 bar (87 psi @ delta-P 7 psi)	700 NI/min (24.7 scfm)					1800 NI/min (63.6 scfm)				
Flow Rate at 6 bar @ delta-P 1 bar (87 psi @ delta-P 15 psi)	1100 NI/min (38.8 scfm)					2700 NI/min (95.3 scfm)				
Min Response ON/OFF	24/50 ms	20/20 ms				39/60 ms	25/25 ms			
Installation	Any	Vertical not recommended with vibration				Any	Vertical not recommended with vibration			
Assembly	On single and manifold bases according to ISO 5599/1									
Manual Override	Locking									
Coils	22mm Form B in Accordance with EN 175301-803-B (11mm pin width)									
Max. Coil Nut Torque	1 Nm / 9 lb-in									
Approvals	N/A									



ISO 5599 Solenoid Valves

ISO 5599 Valve Diagrams

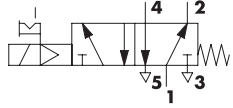

Diagram "A"

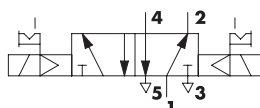

Diagram "B"

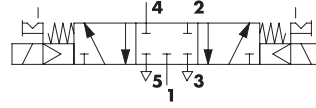

Diagram "C"

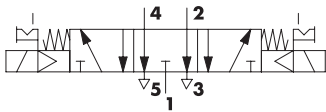

Diagram "D"

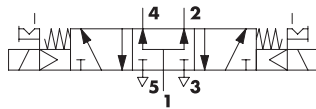
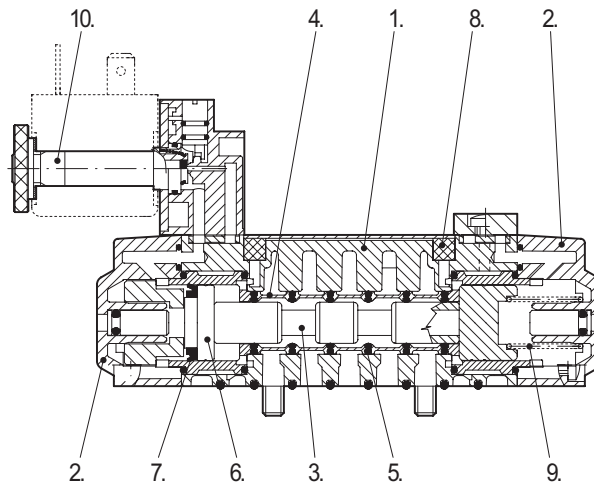

Diagram "E"

ISO 5599 Valve Components

1. VALVE BODY: Aluminium
2. END CAP: Hostaform®
3. SPOOL: chemically nickel-plated aluminium
4. DISTANCE PLATES: plastic
5. GASKETS: NBR (Buna-N)
6. PISTONS: Hostaform®
7. PISTON GASKET: NBR (Buna-N)
8. FILTER: sintered bronze
9. SPRINGS: special steel
10. OPERATOR: Brass pipe – Stainless steel core



ISO 5599 Valve Flow Charts

ISO 1

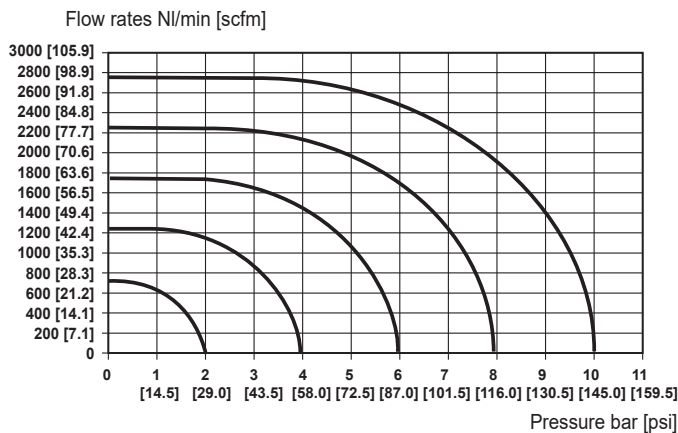

ISO 2

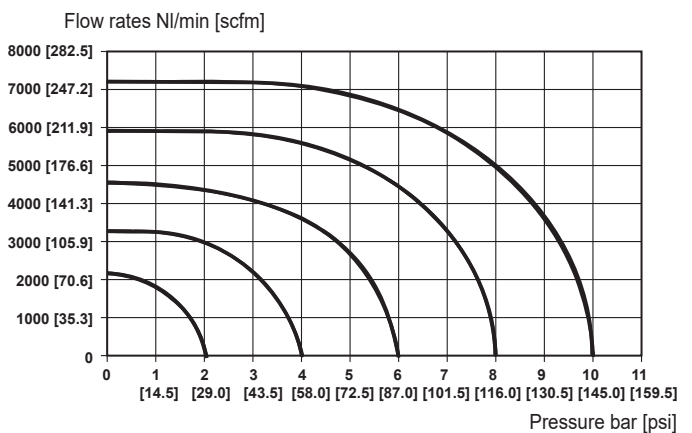



ISO 5599 Solenoid Valve Bases

NITRA ISO 5599 Series Valve Bases allow mounting a single ISO 5599/1 solenoid valve. Bases will fit other brands of ISO 5599/1 valves.

Features

- Stand-alone bases compatible with all ISO 5599/1 valves in sizes 1 and 2
- Available with side or bottom ports
- Available port threads in G-thread (BSPP) or NPT
- Aluminum alloy



See www.AutomationDirect.com
for a wide variety of fitting and
cable options



ISO 5599 Series Valve Bases									
Item Photo	Part No.	Pressure	Inlet(s) / Outlet(s)	Orientation	Usage	Weight (lbs.)	Price	Drawing Link	
	HSB-1SG	145 psi (10 bar) maximum operating pressure	G1/4 female BSPP	Side	ISO 5599/1 size 1 solenoid valves	0.36	\$14.50	PDF	
	HSB-1SN		1/4 in female NPT			0.36	\$14.50	PDF	
	HSB-1BG		G1/4 female BSPP	Bottom		0.43	\$14.00	PDF	
	HSB-1BN		1/4 in female NPT			0.43	\$14.00	PDF	
	HSB-2SG		145 psi (10 bar) maximum operating pressure	G3/8 female BSPP	Side	ISO 5599/1 size 2 solenoid valves	0.57	\$23.00	PDF
	HSB-2SN			3/8 in female NPT			0.57	\$23.00	PDF
	HSB-2BG			G3/8 female BSPP	Bottom		0.67	\$19.50	PDF
	HSB-2BN			3/8 in female NPT			0.67	\$19.50	PDF



ISO 5599 Solenoid Valve Manifolds

NITRA ISO 5599 Series pneumatic valve manifolds can be joined with included fasteners to build valve islands. These manifolds will fit other brands of ISO 5599/1 valves.

Features

- Manifolds compatible with all ISO 5599/1 valves
- Available with side or bottom ports
- Available port threads in G-thread (BSPP) or NPT
- Aluminum alloy



See www.AutomationDirect.com
for a wide variety of fitting and
cable options











ISO 5599 Series Valve Size 1 Manifolds								
Item Photo	Part No.	Pressure	Inlet(s) / Outlet(s)	Orientation	Usage	Weight (lbs.)	Price	Drawing Link
	HM-1G	145 psi (10 bar) maximum operating pressure	G3/8 female BSPP	N/A	ISO 5599/1 size 1 solenoid valves	0.28	\$11.00	PDF
	HM-1N		3/8 in female NPT			0.28	\$11.00	PDF
	HM-1SG		G1/4 female BSPP	Side		0.29	\$26.00	PDF
	HM-1SN		1/4 in female NPT			0.29	\$26.00	PDF
	HM-1BG		G1/4 female BSPP	Bottom		0.69	\$26.00	PDF
	HM-1BN		1/4 in female NPT			0.69	\$26.00	PDF

ISO 5599 Series Valve Size 1 Manifold Accessories					
Item Photo	Part No.	Description	Weight (lbs.)	Price	Drawing Link
	HM-1B	NITRA blind end, aluminum alloy. For use with ISO 5599/1 size 1 manifolds.	0.17	\$5.75	PDF
	HM-1BP	NITRA blanking plate, aluminum alloy. For use with ISO 5599/1 size 1 manifolds. Assembly screws and seal included.	0.10	\$5.75	PDF
	HM-1A	NITRA manifold attaching kit, aluminum alloy. For use with ISO 5599/1 size 1 solenoid valves. Includes (2) assembly clamps and (3) o-rings.	0.10	\$3.00	PDF



ISO 5599 Solenoid Valve Manifolds

ISO 5599 Series Valve Size 2 Manifolds								
Item Photo	Part No.	Pressure	Inlet(s) / Outlet(s)	Orientation	Usage	Weight (lbs.)	Price	Drawing Link
	HM-2G	145 psi (10 bar) maximum operating pressure	G1/2 female BSPP	N/A	ISO 5599/1 size 2 solenoid valves	0.45	\$14.00	PDF
	HM-2N		1/2 in female NPT			0.45	\$14.00	PDF
	HM-2SG		G3/8 female BSPP	Side		0.69	\$31.50	PDF
	HM-2SN		3/8 in female NPT			0.69	\$31.50	PDF
	HM-2BG		3/8 in female NPT	Bottom		1.11	\$31.50	PDF
	HM-2BN		3/8 in female NPT			1.11	\$31.50	PDF

ISO 5599 Series Valve Size 2 Manifold Accessories					
Item Photo	Part No.	Description	Weight (lbs.)	Price	Drawing Link
	HM-2B	NITRA blind end, aluminum alloy. For use with ISO 5599/1 size 2 manifolds.	0.29	\$9.00	PDF
	HM-2BP	NITRA blanking plate, aluminum alloy. For use with ISO 5599/1 size 2 manifolds. Assembly screws and seal included.	0.21	\$7.25	PDF
	HM-2A	NITRA manifold attaching kit, aluminum alloy. For use with ISO 5599/1 size 2 solenoid valves. Includes (2) assembly clamps and (3) o-rings.	0.10	\$3.25	PDF



ISO 5599 Valve Coils

NITRA ISO 5599 Series pneumatic valve coils fit NITRA ISO 5599/1 solenoid valves.





Features

- Voltage tolerance: -10% to + 15%
- Insulation class: F155
- IP65 EN60529 protection with connector
- Coil temperature 100% ED: 55°C at 20°C – ambient temperature
- In accordance to Atex 2014/34/EU rule, group 2, category 3 GD
- Coils have 11mm DIN style connector





See www.AutomationDirect.com
for a wide variety of fitting and
cable options



ISO 5599 Series Valve Coils					
Item Photo	Part No.	Description	Weight (lbs.)	Price	Drawing Link
	<u>HVC-12D</u>	NITRA solenoid coil, 12 VDC, 2W. For use with HVS series solenoid valves.	0.1	\$10.50	<u>PDF</u>
	<u>HVC-24D</u>	NITRA solenoid coil, 24 VDC, 2W. For use with HVS series solenoid valves.	0.1	\$10.50	<u>PDF</u>
	<u>HVC-24A</u>	NITRA solenoid coil, 24 VAC, 3.5VA. For use with HVS series solenoid valves.	0.1	\$10.50	<u>PDF</u>
	<u>HVC-110A</u>	NITRA solenoid coil, 110 VAC, 3.5VA. For use with HVS series solenoid valves.	0.1	\$10.50	<u>PDF</u>
	<u>HVC-220A</u>	NITRA solenoid coil, 220 VAC, 3.5VA. For use with HVS series solenoid valves.	0.1	\$10.50	<u>PDF</u>



ISO 5599 Valve Accessories

ISO 5599 Series Valve Accessories				
Item Photo	Part No.	Description	Weight (lbs.)	Price
	<u>HS-NUT</u>	NITRA solenoid coil nut, replacement. For use with HVS series solenoid valves.	0.05	\$4.25
	<u>HVS-1SEAL</u>	NITRA seal kit, replacement. For use with ISO 5599/1 size 1 solenoid valves. Includes o-rings, lip seals and valve bottom gasket.	0.05	\$3.75
	<u>HVS-2SEAL</u>	NITRA seal kit, replacement. For use with ISO 5599/1 size 2 solenoid valves. Includes o-rings, lip seals and valve bottom gasket.	0.05	\$5.75