

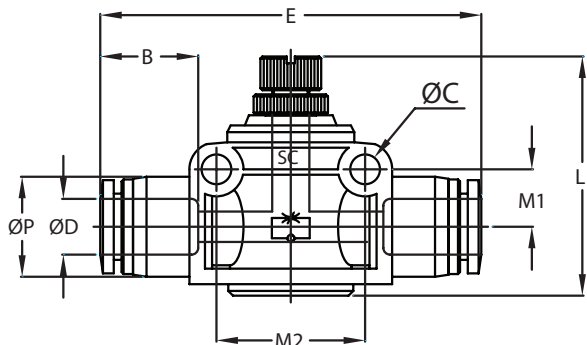

Pneumatic Push-to-Connect Flow Control (Speed Controller) Valves

NITRA pneumatic push-to-connect in-line flow control valve (speed controller) with thermoplastic (PBT) body, nickel-plated brass control knob and stainless steel tube gripping claws. For use with polyurethane or nylon tubing. Two fittings per package.



Inch Fitting



Metric Fitting

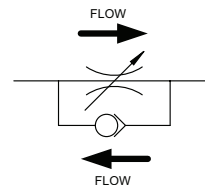

NITRA In-Line														
Inch Sizes - dimensions in inches (in.)														
Part No.	Price	Size	øD	øP	L		E	øC	B	M1	M2	Package Weight (lbs)	Qty. per pack	
					Min.	Max.								
FVU532*	\$18.50	5/32 in. (4 mm) in. x 5/32 in. (4 mm)	5/32	0.41	1.04	1.14	1.76	0.13	0.59	0.22	0.61	0.1	2	
FVU14	\$23.00	1/4 in. x 1/4	1/4	0.52	1.32	1.53	1.97	0.17	0.66	0.31	0.80	0.1	2	
FVU38	\$32.00	3/8 in. x 3/8	3/8	0.69	1.60	1.91	2.42	0.17	0.79	0.41	1.11	0.3	2	
FVU12	\$45.00	1/2 in. x 1/2	1/2	0.81	1.79	2.10	2.78	0.17	0.90	0.48	1.26	0.5	2	
Metric Sizes - dimensions in millimeters (mm)														
FVU6M	\$22.50	6 mm x 6 mm	6	12.5	33.5	37.9	49.6	4.3	16.4	8.0	20.4	0.1	2	
FVU8M	\$28.50	8 mm (5/16 in.) x 8 mm (5/16 in.)	8	14.8	35.5	41.5	56.4	4.4	18.7	8.5	22.0	0.1	2	
FVU10M	\$33.00	10 mm x 10 mm	10	17.5	40.7	48.7	61.4	4.3	20.1	10.3	28.1	0.3	2	
FVU12M	\$44.00	12 mm x 12 mm	12	20.5	45.0	53.5	70.3	4.4	22.8	12.1	32.0	0.5	2	

* FVU532 has blue release rings

Note: Due to changes made by the manufacturer, these flow control valves could have either of the following symbols molded into them:



If the part shows a single arrow, this arrow points in the direction of the controlled flow



If the part shows a dual arrow, the smaller arrow points in the direction of the controlled flow



Pneumatic Push-to-Connect Flow Control (Speed Controller) Valves

Flowrate Charts

1. FVU532

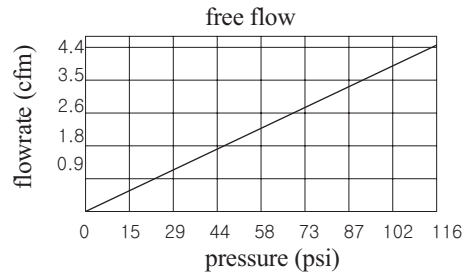
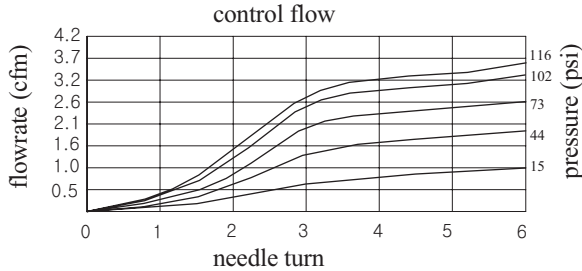

2. FVU14, FVU6M

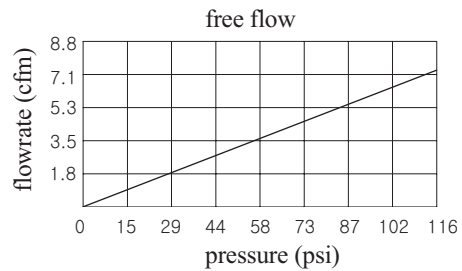
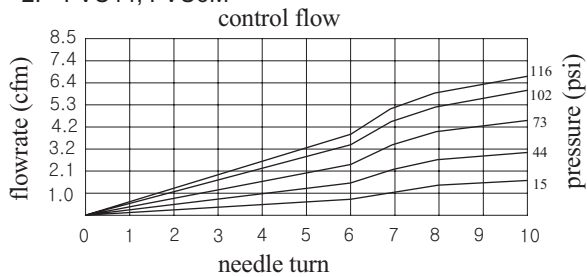

3. FVU8M

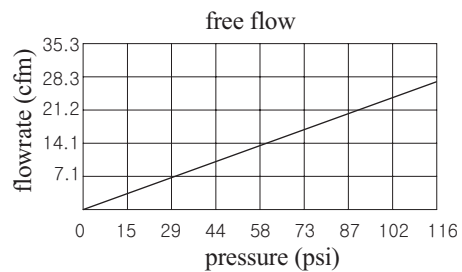
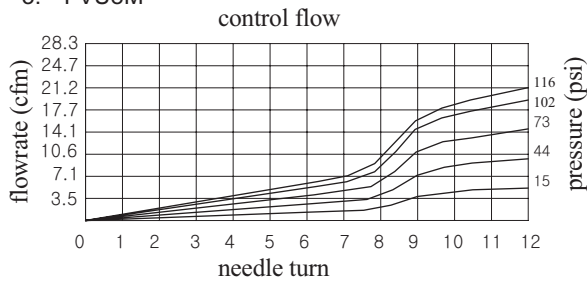

4. FVU38, FVU10M

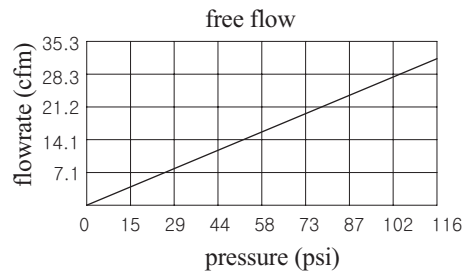
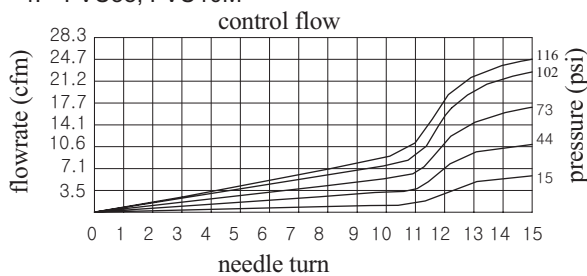

5. FVU12, FVU12M

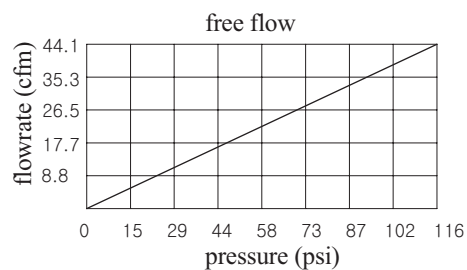
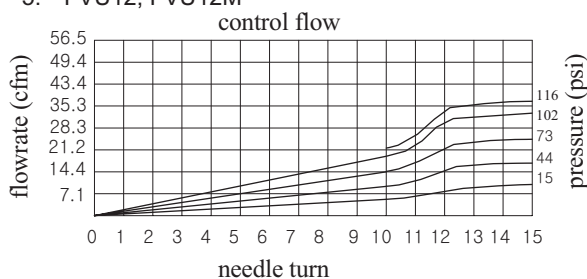



Pneumatic Push-to-Connect Flow Control (Speed Controller) Valves

NITRA Pneumatic Push-to-Connect Flow Control (Speed Controller) Valves provide accurate airflow regulation for precise speed control of pneumatic cylinders. **NITRA** flow control valve bodies are made of a strong thermoplastic (PBT) and have stainless steel tube gripping claws. Threaded

components are made of nickel-plated brass and have pre-applied Teflon thread sealant (O-ring on #10-32, M5 and G threads). Flow control valve bodies can be rotated after installation to allow for variations in piping direction. **NITRA** Polyurethane and Nylon 12 tubing is easily connected by simply inserting the tubing end into the fitting. To release the tubing, press the circular release ring and the tubing can be easily pulled out.

Features

- Meter-in , meter-out and in-line configurations
- Inch and metric sizes available
- NPT, BSPT (R) and BSPP (G) threads available
- Tough thermoplastic bodies, stainless steel tube gripping claws, nickel-plated threads with pre-applied Teflon sealant (O-ring on #10-32, M5 and G threads)
- Bodies can be rotated after installation
- Release rings are color coded to differentiate between meter-in and meter-out
- For use with air only.
- Working pressure: -29.5" Hg to 150 psi.
- Working Temperature 32 to 140°F (0 to 60°C)

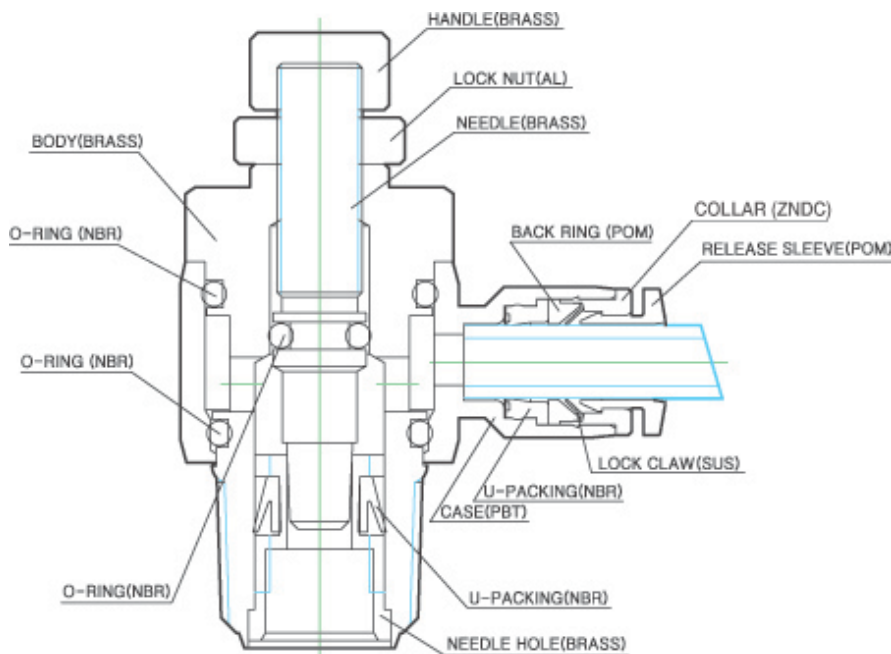

Flow Control Valve Cut-away Diagram