

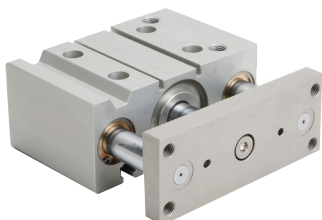

E-Series Dual Guide Rod Cylinders

50 mm Bore, Double Acting



50 mm Bore E-Series Dual Guide Rod Cylinders - Double Acting					
Part Number	Stroke Length (mm)	"A" (mm [in])	"B" (mm [in])	Weight (lbs)	Price
E50M025MD-M	25	69.0 [2.72]	17.0 [0.67]	6.0	\$454.00
E50M030MD-M	30	74.0 [2.91]	17.0 [0.67]	6.3	\$497.00
E50M040MD-M	40	84.0 [3.31]	17.0 [0.67]	6.8	\$497.00
E50M050MD-M	50	94.0 [3.70]	17.0 [0.67]	7.3	\$497.00
E50M075MD-M	75	119.0 [4.69]	46.0 [1.81]	9.8	\$523.00
E50M100MD-M	100	144.0 [5.67]	46.0 [1.81]	11.0	\$559.00
E50M125MD-M	125	169.0 [6.65]	62.0 [2.44]	12.5	\$595.00
E50M150MD-M	150	194.0 [7.64]	62.0 [2.44]	13.8	\$591.00
E50M175MD-M	175	219.0 [8.62]	62.0 [2.44]	15.1	\$516.00
E50M200MD-M	200	244.0 [9.61]	62.0 [2.44]	16.4	\$700.00
E50M250MD-M	250	294.0 [11.6]	89.0 [3.50]	19.6	\$794.00

Dimensions

mm [in]

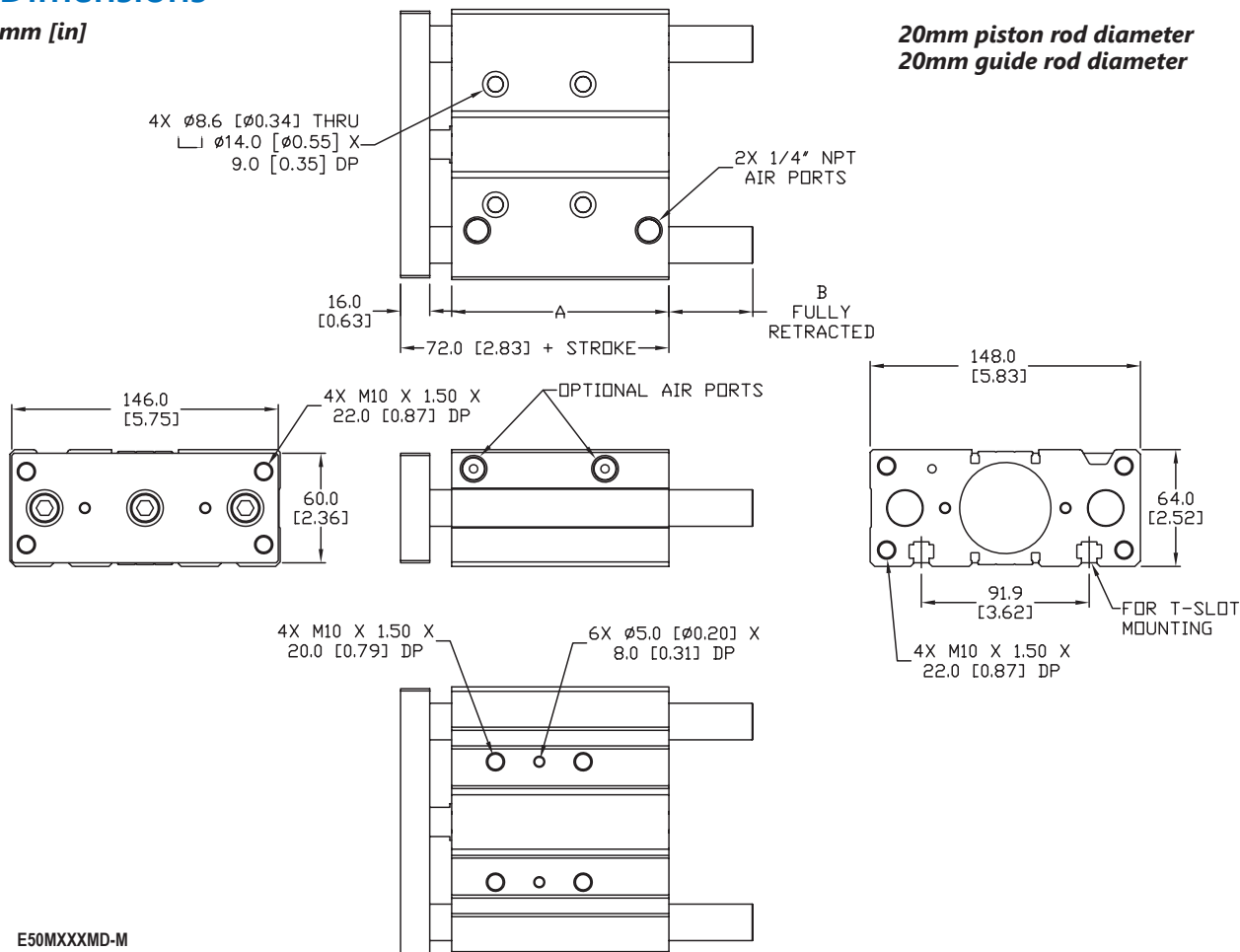

See our website www.AutomationDirect.com for complete Engineering drawings.



E-Series Dual Guide Rod Cylinders - Load and Torque Ratings

Cylinder Max Side Load Ratings (lbs)													
Bore Size (mm)	Stroke (mm)												
	10	20	25	30	40	50	75	100	125	150	175	200	250
12	9.9	7.4	6.5	5.9	9.2	8.1	5.9	5.0	4.3	3.8	-	-	-
16	15	11	9.5	8.3	14	13	8.3	7.2	6.1	5.4	5.0	4.5	-
20	-	18	14	13	28	25	20	17	15	13	12	11	9.5
25	-	21	20	17	32	29	23	19	20	18	16	15	12
32	-	-	46	43	40	37	41	35	32	29	26	24	20
40	-	-	46	43	40	37	41	35	32	29	26	24	20
50	-	-	67	64	60	55	61	54	49	44	40	37	32
63	-	-	67	64	60	55	61	54	49	44	40	37	32

Conversion: 1 lb = 4.45 N

Cylinder Max Torque Ratings (in-lb)													
Bore Size (mm)	Stroke (mm)												
	10	20	25	30	40	50	75	100	125	150	175	200	250
12	7.97	6.99	6.28	5.75	6.82	6.37	4.43	3.19	2.74	2.39	-	-	-
16	10.7	9.20	8.32	7.79	10.89	9.82	6.11	5.13	4.43	3.89	3.54	3.19	-
20	-	13.9	12.6	11.6	21.2	19.0	16.6	14.4	12.7	11.3	10.3	9.38	7.97
25	-	21.2	19.6	17.8	32.4	29.7	26.2	22.7	20.0	17.9	16.2	14.8	12.6
32	-	-	56.2	53.1	50.7	45.4	50.4	44.0	39.1	35.2	32.0	29.3	25.1
40	-	-	62.0	58.4	54.1	50.1	55.5	48.5	43.1	38.8	35.2	32.3	27.7
50	-	-	115	112	97.4	95.6	106	93.8	84.1	76.1	69.6	64.1	55.2
63	-	-	130	120	114	107	119	105	94.7	85.8	78.4	72.2	62.3

Conversion: 1 in-lb = 0.113 N-m



E-Series Dual Guide Rod Cylinders

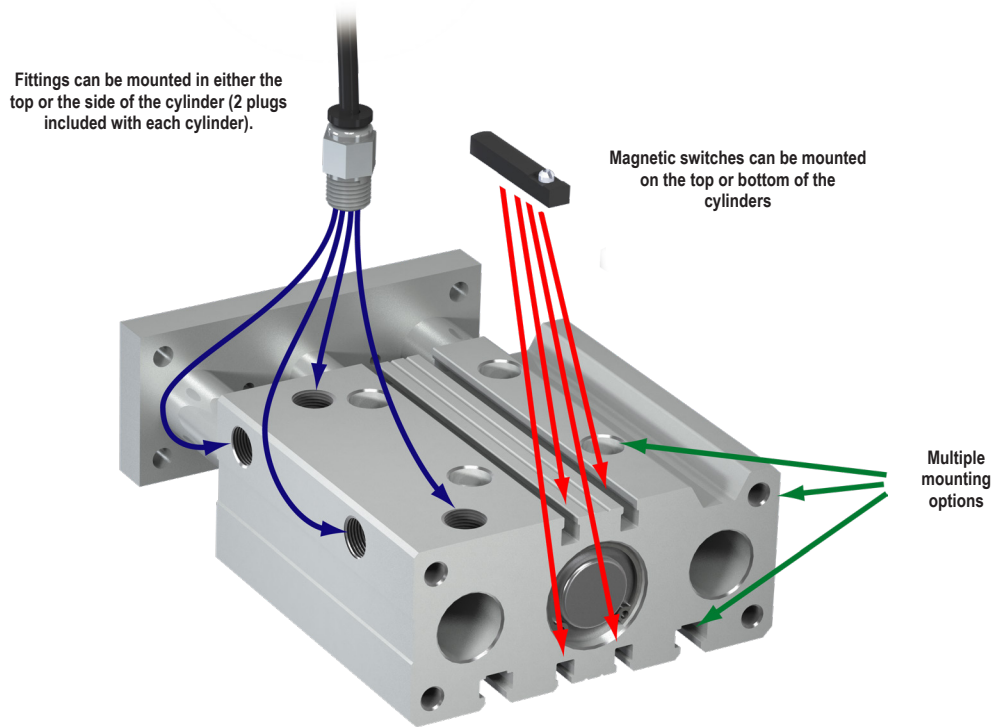

NITRA pneumatic guided actuator with dual guide rods, bronze bushings, extruded aluminum housing and switch mounting tracks.

- Mild steel tooling plate
- Nitrile / Buna-N O-rings

- Eight bore sizes
- Interchangeable with other popular brands
- Work with 4mm square T-slot cylinder switches
- Chrome plated stainless steel guide rods



E-Series Dual Guide Rod Cylinder Specifications								
Bore Size (mm)	12	16	20	25	32	40	50	63
Action	Double acting							
Fluid	Air (clean/dry)							
Temperature Range	23 to 158°F (-5 to 70°C)							
Pressure Range	18-142 psi (1.2-10 bar)							
Proof Pressure	213 psi (15 bar)							
Lubrication	Not required							
Cushion Type	Urethane Bumper							
Non-Rotate Tolerance	±0.10°		±0.09°		±0.08°		±0.06°	
Port Size	M5x0.8		1/8-NPT				1/4-NPT	
Extend Force @ 100 psi (lbs.)	17.5	31.2	48.7	76.1	124.7	194.8	304.3	483.2
Retract Force @ 100 psi (lbs.)	9.7	19.0	31.2	44.9	76.0	146.1	255.6	434.5



CPS Series Cylinder Position Switches

Position Switch Cross Reference Chart			
NITRA Switch Type	Cylinder Brand (may fit some of these cylinders)	Photo Example	Groove Illustration
CPS CPSF	NITRA A-Series NITRA D-Series NITRA F-Series		
CPS9C	DE-STA-CO Robohand SMC Compact Air Bimba Fabco		
CPS9D	NITRA L-Series Fabco Numatics Rotomation		
CPS9E	NITRA L-Series Fabco Numatics Rotomation		
CPS9F	NITRA G-Series Fabco Festo Numatics Rotomation		
CPS9H	NITRA E-Series NITRA H-Series		
CPS9M	Norgren		
CPS9Q	NITRA L-Series NITRA G-Series Parker Fabco Festo Numatics Rotomation		