



Stepping System Cables

SureStep® Cables

SureStep Series – Stepping System Cables						
Cable	Price	Purpose	Length	Use With	Cable End Connectors	Drawing
STP-EXT-006	\$13.00	motor to drive extension	6 ft	STP-MTR-xxxx(x)	pigtail / Molex 43020-0401 connector	PDF
STP-EXT-010	\$14.50		10 ft			PDF
STP-EXT-020	\$18.50		20 ft			PDF
STP-EXTH-006	\$26.50		6 ft	STP-MTRH-xxxx(x)	pigtail / Molex 39-01-2041 connector	PDF
STP-EXTH-010	\$31.50		10 ft			PDF
STP-EXTH-020	\$38.00		20 ft			PDF
STP-EXTHW-006	\$50.00		6 ft	STP-MTRHW-xxxx(x)	Bulgin # PXP4011/06P/6065	PDF
STP-EXTHW-010	\$55.00		10 ft			PDF
STP-EXTHW-020	\$71.00		20 ft			PDF
STP-EXTL-006	\$11.50		6 ft	STP-MTRL-xxxx(x)	pigtail / Molex 105308-22004 connector	PDF
STP-EXTL-010	\$14.50		10 ft			PDF
STP-EXTL-020	\$18.00		20 ft			PDF
STP-EXTW-006	\$50.00	6 ft	STP-MTRW-xxxx(x)	Bulgin # PXP4011/06P/6065	PDF	
STP-EXTW-010	\$55.00	10 ft			PDF	
STP-EXTW-020	\$71.00	20 ft			PDF	
STP-EXT42-006	\$26.00	motor to drive extension	6 ft	STP-MTRAC-42xxxx	10-pin / pigtail	PDF
STP-EXT42-010	\$31.00		10 ft			PDF
STP-EXT42-020	\$44.50		20 ft			PDF
STP-EXT42H-006	\$26.00		6 ft	STP-MTRACH-42xxxx		PDF
STP-EXT42H-010	\$31.00		10 ft			PDF
STP-EXT42H-020	\$44.50		20 ft			PDF
STP-232RJ11-CBL*	\$11.00	programming/ communication	10 ft	STP-DRV-4850, STP-DRV-80100	DB9 female / RJ11(6P4C)	PDF
STP-232HD15-CBL-2**	\$17.00	communication	6.6 ft	STP-DRV-4850, STP-DRV-80100 DL06, D2-250-1, D2-260	HD 15-pin male / RJ12 6-pin plug	n/a
STP-232RJ12-CBL-2**	\$10.50	communication	6.6 ft	STP-DRV-4850, STP-DRV-80100 DL05, CLICK	RJ11 (6P4C) plug / RJ12 6-pin plug	n/a
STP-CBL-CA6	\$19.00	control cable	6 ft	STP-MTRD-17038 STP-MTRD-17038E	11-pin / pigtail	PDF
STP-CBL-CA10	\$23.00	control cable	10 ft		11-pin / pigtail	PDF
STP-CBL-CA20	\$33.50	control cable	20 ft		11-pin / pigtail	PDF
STP-CBL-EA6	\$19.00	encoder cable	6 ft	STP-MTRD-xxxxE STP-MTRA-ENC1, STP-MTRA-ENC3 STP-MTRA-ENC5, STP-MTRA-ENC7 STP-MTRA-ENC11, STP-MTRA-ENC13 (for line driver encoders)	10-pin / pigtail	PDF
STP-CBL-EA10	\$23.00	encoder cable	10 ft		10-pin / pigtail	PDF
STP-CBL-EA20	\$33.50	encoder cable	20 ft		10-pin / pigtail	PDF
STP-CBL-EB3	\$31.00	encoder cable	3 ft	AMT112Q-V AMT112S-V (for both line driver and push-pull (totem) encoders)	17-pin / pigtail	PDF
STP-CBL-EB6	\$48.50	encoder cable	6 ft		17-pin / pigtail	PDF
STP-CBL-EB10	\$72.00	encoder cable	10 ft		17-pin / pigtail	PDF
STP-CBL-EB20	\$133.00	encoder cable	20 ft		17-pin / pigtail	PDF
STP-CBL-ED6	\$19.00	encoder cable	6 ft	STP-MTRA-ENC2, STP-MTRA-ENC4 STP-MTRA-ENC6, STP-MTRA-ENC8 STP-MTRA-ENC12, STP-MTRA-ENC14 (for push-pull (totem) encoders)	5-pin / pigtail	PDF
STP-CBL-ED10	\$23.50	encoder cable	10 ft		5-pin / pigtail	PDF
STP-CBL-ED20	\$34.50	encoder cable	20 ft		5-pin / pigtail	PDF
STP-CON-1	\$18.00	replacement connector kit	n/a	STP-DRV-4845 & -6575	-	n/a
STP-CON-2	\$18.00	replacement connector kit	n/a	STP-DRV-4850 & 80100	-	n/a

* Programming/communication cable [STP-232RJ11-CBL](#) is available for spare or replacement purposes.
(One cable is included with each software programmable drive.)

** Refer to the [ZIPLinks Wiring Solutions](#) section for complete information regarding cables [STP-232HD15-CBL-2](#) and [STP-232RJ12-CBL-2](#).



Stepping System Cables

SureStep® Cables, continued

STP-CBL-EDxx Encoder Cable Wiring Diagram

STP-EDxx CABLES

PIN#	Function	Color
1	Ground	Black
2	Index	Green
3	A Channel	White
4	+5VDC Power	Red
5	B Channel	Brown

TABLE INFORMATION	
CABLE NUMBER	CABLE LENGTH L
STP-CBL-ED6	6 Feet
STP-CBL-ED10	10 Feet
STP-CBL-ED20	20 Feet

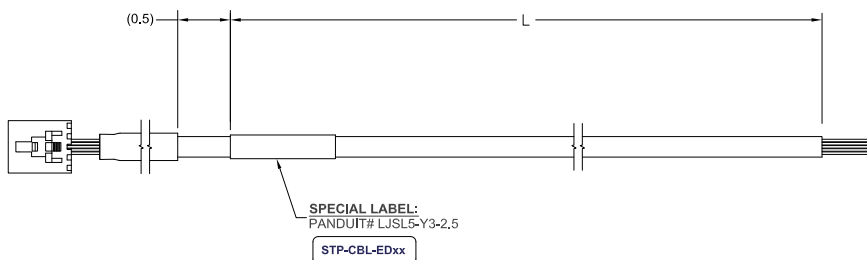

STP-EXT42(H)-xxx Cable Wiring Diagram

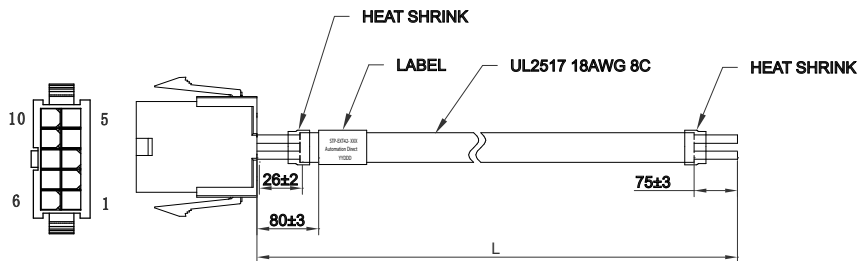

Pin	Wire Description
1	A - White
2	A̅ - Orange
3	C - Green
4	C̅ - Brown
5	B - Red
6	B̅ - Yellow
7	D - Black
8	D̅ - Blue
9	GND - Drain wire

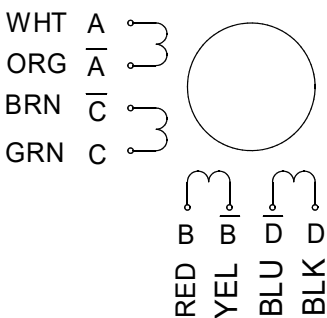

Bi-polar series

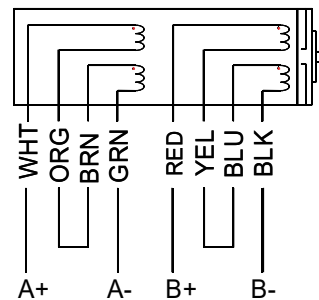

Bi-polar parallel

