

IDEM WPR and WMR Heavy Duty Non-Contact Magnetic Safety Switches

WPR Series Plastic Housing

WMR Series Stainless Steel Housing



- Robust wide housing suitable for all industry applications
- Can be high-pressure hosed at high temperature - IP69K rated
- Wide 12 mm sensing, high tolerance to misalignment
- High switching capability - up to 2A
- Will operate with most safety relays
- Codes are not unique and can be used with other models of the same series
- Available with 2m or 5m cable or 250mm pigtail with quick-disconnect cable

WMR Series only

- Specifically designed for food processing applications
- Suitable for CIP SIP cleaning - Food Splash Zones per EHEDG guidelines
- 316 Stainless steel mirror polished finish
- Can be high-pressure hosed at high temperature - IP69K rated

See Dimensions later in this section.

Actuator Operating Direction

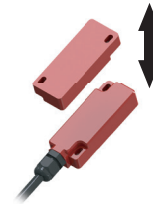

WPR/WMR Non-Contact Magnetic Safety Switches					
Part Number	Price	Body Material	Cable Length	Circuits	Contact Type / Rating
<i>Pigtail Versions</i>					
<u>WPR-112005</u>	\$154.00	Plastic	2m	2 NC, 1 NO	Heavy duty / 2A
<u>WPR-112006</u>	\$163.00		5m		
<i>Quick Disconnect Versions (M12 8-pin)</i>					
<u>WPR-112008</u>	\$185.00	Plastic	250mm	2 NC, 1 NO	Heavy duty / 2A
<u>WMR-136008</u>	\$247.00	Stainless Steel	250mm		

Female Quick Disconnect Lead			
Part Number	Price	Description	Exit Type/Cable Length
<u>140101</u>	\$59.00	Female QD Lead	M12 Female 5m, 8-pin
<u>140102</u>	\$88.00		M12 Female 10m, 8-pin



IDEM WPR and WMR Heavy Duty Non-Contact Magnetic Safety Switches

Dimensions

mm [in]

WPR Series

Pigtail

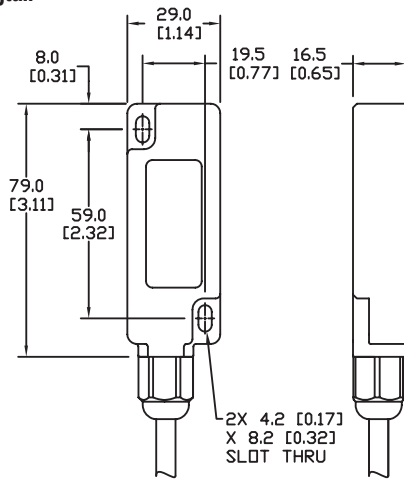

SWITCH

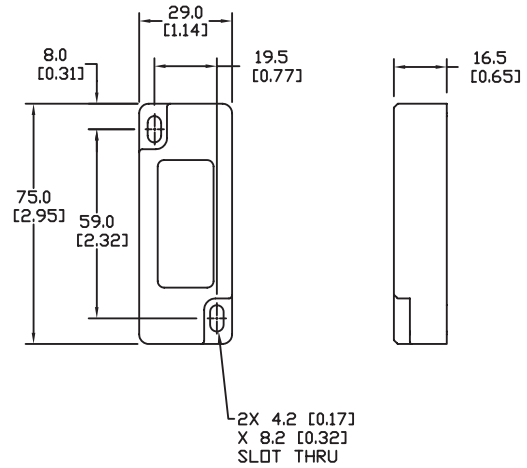

ACTUATOR

Quick Disconnect

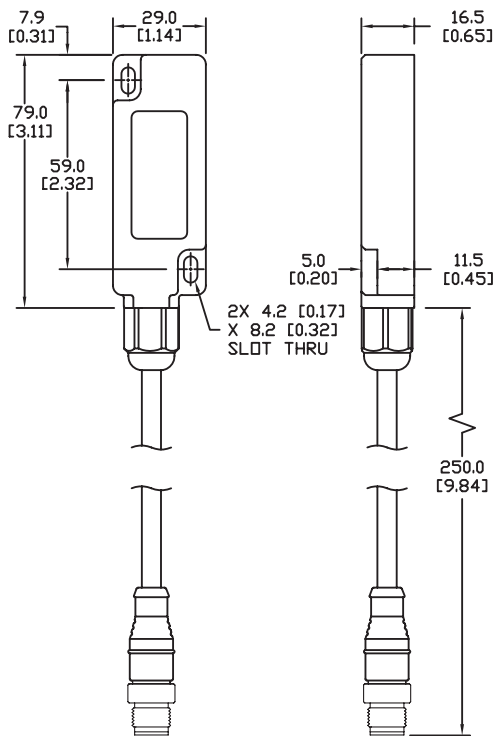

SWITCH

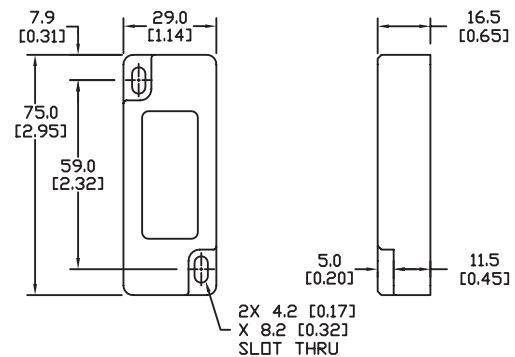

ACTUATOR

See our website: www.AutomationDirect.com for complete Engineering drawings.

IDEM WPR and WMR Heavy Duty Non-Contact Magnetic Safety Switches

Dimensions

mm [in]

WMR Series

Quick Disconnect

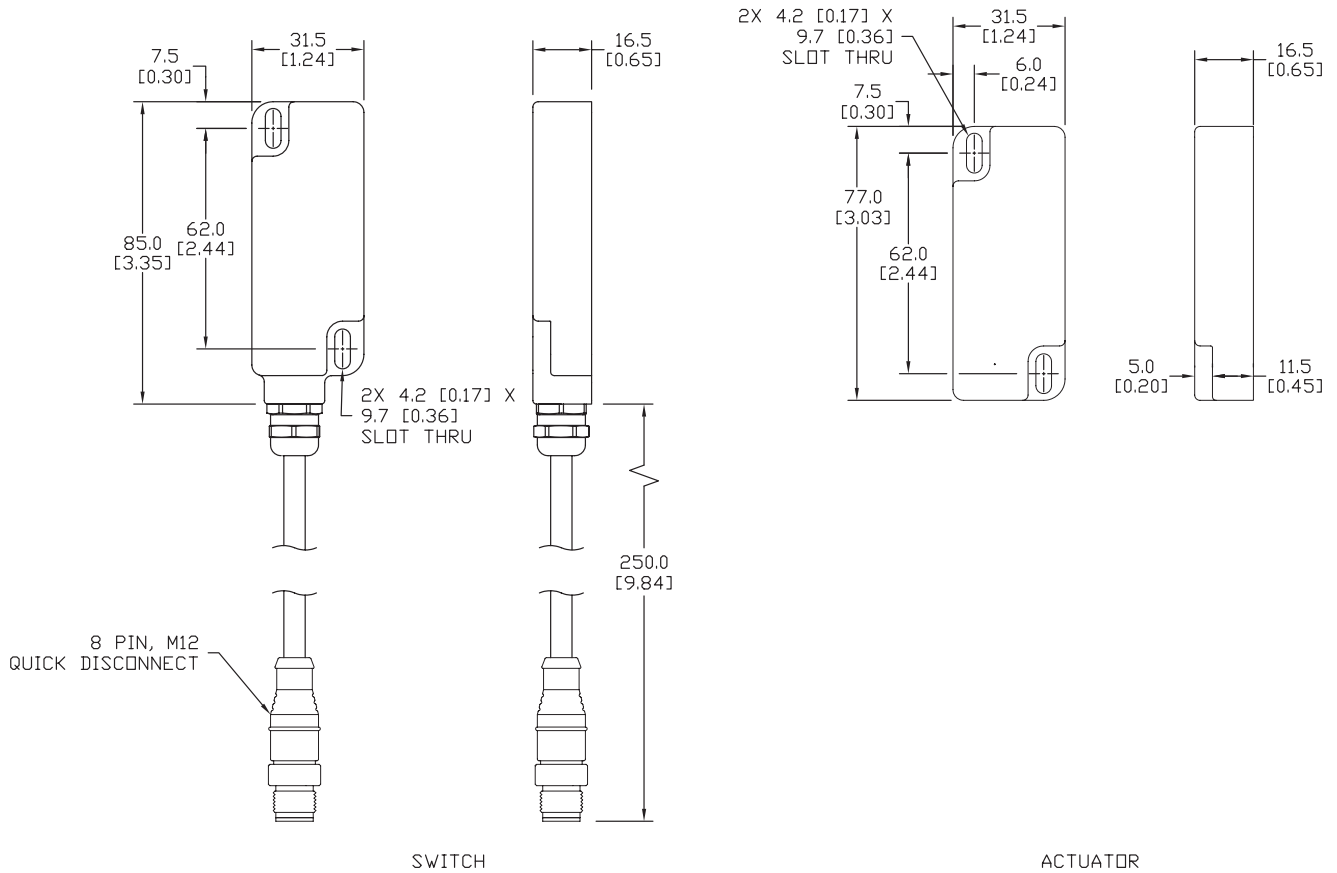

See our website: www.AutomationDirect.com for complete Engineering drawings.

IDEM Non-Contact Safety Switches

Electrical Connections and Dimensions

Electrical Connections

Magnetic Switches

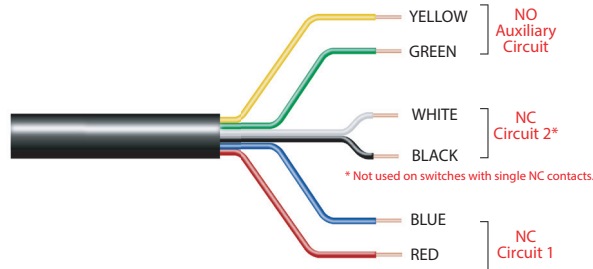

Magnetic Switches - Electrical Connections		
Quick Disconnect Connector Pin Out	Lead Color	Type of Circuit (Actuator Present)
4	Yellow	Auxiliary (NO)
6	Green	Auxiliary (NO)
7	Black	NC2
1	White	NC2
2	Red	NC1
3	Blue	NC1

Coded Magnetic and RFID Switches

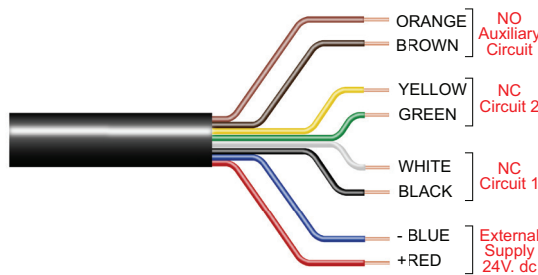

Coded Magnetic Switches - Electrical Connections			
Quick Disconnect Connector Pin Out	Lead Color	Type of Circuit (Actuator Present)	Output Types (Solid State)
8	Orange	Auxiliary (NO)	200 mA max. 24 VDC
5	Brown	Auxiliary (NO)	
4	Yellow	NC2 +	200 mA max. 24 VDC (Optocoupler)
6	Green	NC2 -	
7	Black	NC1 +	200 mA max. 24 VDC (Optocoupler)
1	White	NC1 -	
2	Red	Supply +24 VDC	Supply 24 VDC +10% / -15%
3	Blue	Supply 0VDC	

Connection Colors

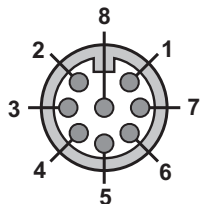

Pin View from Switch
M12 Male

IDEM Non-Contact Safety Switches Specifications

Non-contact Safety Switches Specifications			
	Non-Contact Magnetic Switches	Non-Contact Coded Magnetic Switches	Non-Contact RFID Coded Switches
Safety Classification and Reliability Data			
Switching Reliability (B10d)	3.3 x 10 ⁶ operations at 100mA load	No mechanical parts implemented	No mechanical parts implemented
ISO 13849-1	Up to Category 4		
ISO 13849-1	Up to PLe depending upon system architecture		
EN 62061	Up to SIL3 depending upon system architecture		
Safety Data - Annual Usage	8 cycles per hour / 24 hours per day / 365 days		
PFHd	2.8 x 10 ⁻¹⁰	2.6 x 10 ⁻¹⁰	4.77 x 10 ⁻¹⁰
Proof Test Interval (Life)	20 years		
MTTFd	470 years	866 years	1100 years
Agency Approvals	CE, cULus		
Electrical and General Specifications			
Contact Ratings: Safety Contact NC	MPR: Voltage free: 250VAC, 0.5 A max.	24VDC, 0.2 A max (optocoupler)	24VDC, 0.2 A max (optocoupler)
	LPR, LMR, SPR, SMR, SMR-F: Voltage free: 250VAC, 1.0 A max.		
	CPR, CMR, CMR-F, WPR: Voltage free: 250VAC, 2.0 A max.		
	BPR, BMR: 240VAC, 24VAC/DC, 1.0 A max.		
Contact Ratings: Monitoring (Auxiliary) Contact NO	Voltage free: 24VDC, 0.2 A max.	24VDC, 0.2A max.	24VDC, 0.2A max.
Recommended Fuses (NC Circuits)	MPR: Fuse externally 0.4 A (F)	NA	NA
	LPR, LMR, SPR, SMR, SMR-F, CMR, CMR-F: Fuse externally 0.8 A (F)		
	CPR, WPR: Fuse externally 1.6 A (F)		
	BPR, BMR: Fuse externally 0.5 A (F)		
Contact Release Time	<2ms	NA	NA
Initial Contact Resistance	<0.5 Ω	NA	NA
Minimum Switched Current	10 DC, 1mA		
Dielectric Withstand	250VAC		
Insulation Resistance	100 Megohms		
Recommended Setting Gap	5mm [0.20 in]		
NC Switching Distance	Sao (assured ON) 8mm [0.31 in] close; Sar (assured OFF) 20mm [0.79 in] open		
NC Switching Operation	For all switches the NC circuits are closed when the guard is closed and the actuator is present.		
NO Switching Operation	Opens before NC circuits close		
Tolerance to Misalignment	5mm [0.20 in] in any direction from 5mm [0.20 in] setting gap (See Misalignment Range drawing on this page)		
Switching Frequency	1.0 Hz Max.		
Approach Speed	200mm [7.87 in] per minute to 1000mm [39.37] per second		
Body Material - Polyester	CPR, LPR, MPR, SPR, WPR, BPR	CPC, LPC, MPC, SPC, WPC	LPF, SPF, BPF
Body Material - 316 Stainless Steel	CMR, CMR-F, LMR, SMR, SMR-F, BMR	CMC, CMC-F, LMC, SMC, SMC-F	LMF, BMF
Operating Temperature Range	Polyester: -25° to +80°C (-13° to +176° F)		
	316 Stainless Steel: -25° to +105° C [-13° to +221° F]	316 Stainless Steel: -25° to +105° C [-13° to +221° F]	-25° to +80° C [-13° to +176° F]
Storage Temperature (Low)	-55° to -40° C [-67° to -40° F]		
Enclosure Protection	IP67, IP69K (QC versions are IP67 due to connector)		
Shock Resistance	IEC 68-2-27 11ms 30g		
Vibration Resistance	IEC 68-2-6 10-55 Hz 1mm [0.04 in]		
Cable Type	PVC, 6.5 mm outside diameter max.	PVC, 6.5 mm outside diameter max.	PVC, 6mm [0.24 in] outer diameter max.
Mounting Bolts (recommended)	2 x M4; Tightening torque: 1.0 N•m [0.74 lb•ft]		

Note: Always mount onto non-ferrous materials.

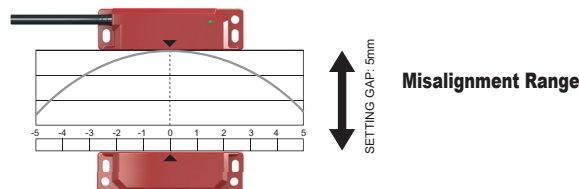

Safety Products



Warning: Safety products sold by AutomationDirect are Safety components only. The purchaser/installer is solely responsible for the application of these components and ensuring all necessary steps have been taken to assure each application and use meets all performance and applicable safety requirements and/or local, national and/or international safety codes as required by the application. AutomationDirect cannot certify that our products, used solely or in conjunction with other AutomationDirect or other vendors' products, will assure safety for any application. Any person using or applying any products sold by AutomationDirect is responsible for learning the safety requirements for their individual application and applying them, and therefore assumes all risks, and accepts full and complete responsibility, for the selection and suitability of the product for their respective application.

AutomationDirect does not provide design or consulting services, and cannot advise whether any specific application or use of our products would ensure compliance with the safety requirements for any application.