

# IDEM LPR and LMR Medium Duty Non-Contact Magnetic Safety Switches

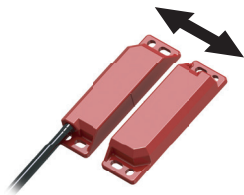

**Actuator Operating Direction**



**LPR, LMR**

## LPR Series Plastic Housing

## LMR Series Stainless Steel Housing

- Popular housing suitable for all industry applications
- Narrow style for flush mounting
- Can be high-pressure hosed at high temperature - IP69K rated
- Medium duty 1A
- Wide 12 mm sensing, high tolerance to misalignment
- Will operate with most safety relays
- Available with 2m, 5m, or 10m cable or 250mm pigtail with quick-disconnect cable
- Codes are not unique and can be used with other models of the same series

### **LMR Series Only**

- Specifically designed for food processing applications
- Suitable for CIP SIP cleaning - food splash zones per EHEDG guidelines
- 316 Stainless steel mirror polished finish

*See Dimensions later in this section.*

LPR and LMR Non-Contact Magnetic Safety Switches					
Part Number	Price	Body Material	Cable Length	Circuits	Contact Type / Rating
<b>Pigtail Versions</b>					
<a href="#"><u>LPR-110013</u></a>	\$123.00	Plastic	2m	2 NC, 1 NO	Medium duty / 1A
<a href="#"><u>LPR-110014</u></a>	\$132.00		5m		
<a href="#"><u>LPR-110015</u></a>	\$148.00		10m		
<a href="#"><u>LMR-133013</u></a>	\$202.00	Stainless steel	2m		
<a href="#"><u>LMR-133014</u></a>	\$212.00		5m		
<a href="#"><u>LMR-133015</u></a>	\$228.00		10m		
<b>Quick Disconnect Versions (M12 8-pin)</b>					
<a href="#"><u>LMR-133016</u></a>	\$234.00	Stainless steel	250mm	2 NC, 1 NO	Medium duty / 1A

Female Quick Disconnect Lead			
Part Number	Price	Description	Exit Type/Cable Length
<a href="#"><u>140101</u></a>	\$59.00	Female QD Lead	M12 Female 5m, 8-pin
<a href="#"><u>140102</u></a>	\$88.00		M12 Female 10m, 8-pin



# IDEM LPR and LMR Medium Duty Non-Contact Magnetic Safety Switches

## Dimensions

mm [in]

**LPR Series**

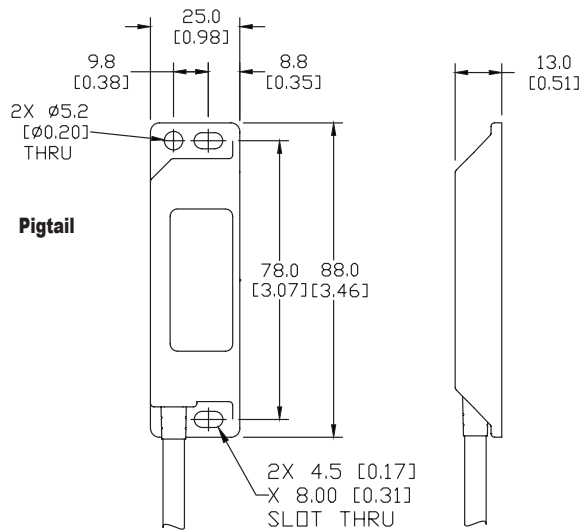

SWITCH

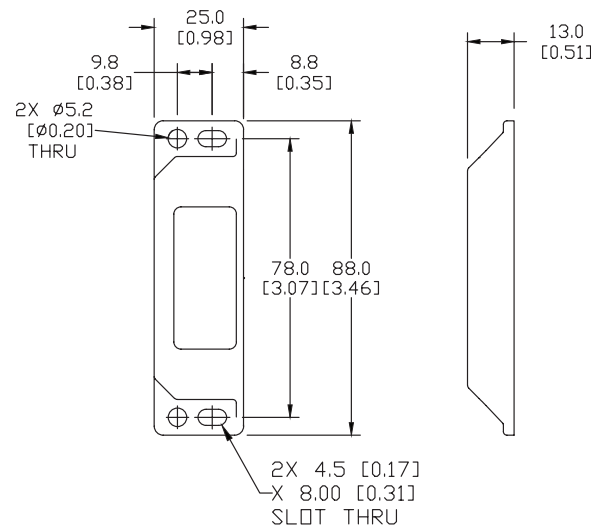

ACTUATOR

See our website: [www.AutomationDirect.com](http://www.AutomationDirect.com) for complete Engineering drawings.

# IDEM LPR and LMR Medium Duty Non-Contact Magnetic Safety Switches

## Dimensions

mm [in]

### LMR Series

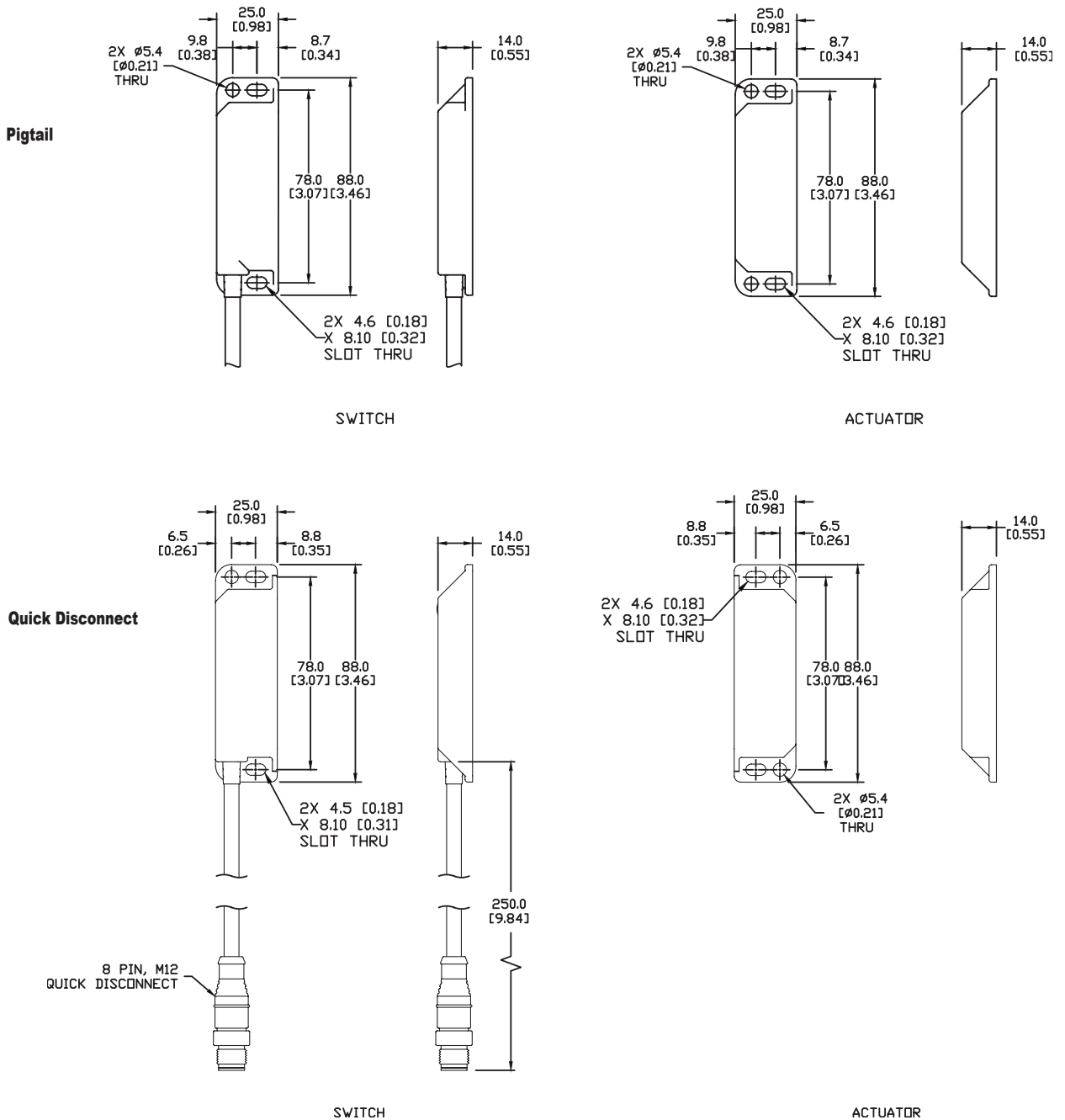

See our website: [www.AutomationDirect.com](http://www.AutomationDirect.com) for complete Engineering drawings.

# IDEM Non-Contact Safety Switches

## Electrical Connections and Dimensions

### Electrical Connections

#### Magnetic Switches

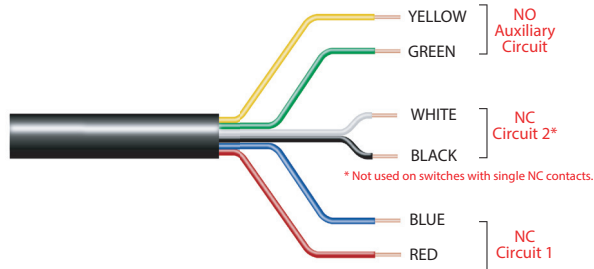

Magnetic Switches - Electrical Connections		
Quick Disconnect Connector Pin Out	Lead Color	Type of Circuit (Actuator Present)
4	Yellow	Auxiliary (NO)
6	Green	Auxiliary (NO)
7	Black	NC2
1	White	NC2
2	Red	NC1
3	Blue	NC1

#### Coded Magnetic and RFID Switches

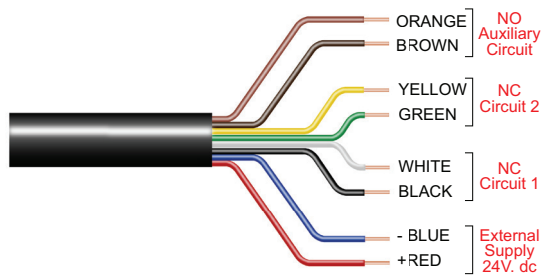

Coded Magnetic Switches - Electrical Connections			
Quick Disconnect Connector Pin Out	Lead Color	Type of Circuit (Actuator Present)	Output Types (Solid State)
8	Orange	Auxiliary (NO)	200 mA max. 24 VDC
5	Brown	Auxiliary (NO)	
4	Yellow	NC2 +	200 mA max. 24 VDC (Optocoupler)
6	Green	NC2 -	
7	Black	NC1 +	200 mA max. 24 VDC (Optocoupler)
1	White	NC1 -	
2	Red	Supply +24 VDC	Supply 24 VDC +10% / -15%
3	Blue	Supply 0VDC	

#### Connection Colors

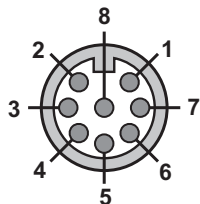

Pin View from Switch  
M12 Male

# IDEM Non-Contact Safety Switches Specifications

Non-contact Safety Switches Specifications			
	Non-Contact Magnetic Switches	Non-Contact Coded Magnetic Switches	Non-Contact RFID Coded Switches
<b>Safety Classification and Reliability Data</b>			
<b>Switching Reliability (B10d)</b>	3.3 x 10 <sup>6</sup> operations at 100mA load	No mechanical parts implemented	No mechanical parts implemented
<b>ISO 13849-1</b>	Up to Category 4		
<b>ISO 13849-1</b>	Up to PLe depending upon system architecture		
<b>EN 62061</b>	Up to SIL3 depending upon system architecture		
<b>Safety Data - Annual Usage</b>	8 cycles per hour / 24 hours per day / 365 days		
<b>PFHd</b>	2.8 x 10 <sup>-10</sup>	2.6 x 10 <sup>-10</sup>	4.77 x 10 <sup>-10</sup>
<b>Proof Test Interval (Life)</b>	20 years		
<b>MTTFd</b>	470 years	866 years	1100 years
<b>Agency Approvals</b>	CE, cULus		
<b>Electrical and General Specifications</b>			
<b>Contact Ratings: Safety Contact NC</b>	MPR: Voltage free: 250VAC, 0.5 A max.	24VDC, 0.2 A max (optocoupler)	24VDC, 0.2 A max (optocoupler)
	LPR, LMR, SPR, SMR, SMR-F: Voltage free: 250VAC, 1.0 A max.		
	CPR, CMR, CMR-F, WPR: Voltage free: 250VAC, 2.0 A max.		
	BPR, BMR: 240VAC, 24VAC/DC, 1.0 A max.		
<b>Contact Ratings: Monitoring (Auxiliary) Contact NO</b>	Voltage free: 24VDC, 0.2 A max.	24VDC, 0.2A max.	24VDC, 0.2A max.
<b>Recommended Fuses (NC Circuits)</b>	MPR: Fuse externally 0.4 A (F)	NA	NA
	LPR, LMR, SPR, SMR, SMR-F, CMR, CMR-F: Fuse externally 0.8 A (F)		
	CPR, WPR: Fuse externally 1.6 A (F)		
	BPR, BMR: Fuse externally 0.5 A (F)		
<b>Contact Release Time</b>	<2ms	NA	NA
<b>Initial Contact Resistance</b>	<0.5 Ω	NA	NA
<b>Minimum Switched Current</b>	10 DC, 1mA		
<b>Dielectric Withstand</b>	250VAC		
<b>Insulation Resistance</b>	100 Megohms		
<b>Recommended Setting Gap</b>	5mm [0.20 in]		
<b>NC Switching Distance</b>	Sao (assured ON) 8mm [0.31 in] close; Sar (assured OFF) 20mm [0.79 in] open		
<b>NC Switching Operation</b>	For all switches the NC circuits are closed when the guard is closed and the actuator is present.		
<b>NO Switching Operation</b>	Opens before NC circuits close		
<b>Tolerance to Misalignment</b>	5mm [0.20 in] in any direction from 5mm [0.20 in] setting gap (See Misalignment Range drawing on this page)		
<b>Switching Frequency</b>	1.0 Hz Max.		
<b>Approach Speed</b>	200mm [7.87 in] per minute to 1000mm [39.37] per second		
<b>Body Material - Polyester</b>	CPR, LPR, MPR, SPR, WPR, BPR	CPC, LPC, MPC, SPC, WPC	LPF, SPF, BPF
<b>Body Material - 316 Stainless Steel</b>	CMR, CMR-F, LMR, SMR, SMR-F, BMR	CMC, CMC-F, LMC, SMC, SMC-F	LMF, BMF
<b>Operating Temperature Range</b>	Polyester: -25° to +80°C (-13° to +176° F)		
	316 Stainless Steel: -25° to +105° C [-13° to +221° F]	316 Stainless Steel: -25° to +105° C [-13° to +221° F]	-25° to +80° C [-13° to +176° F]
<b>Storage Temperature (Low)</b>	-55° to -40° C [-67° to -40° F]		
<b>Enclosure Protection</b>	IP67, IP69K (QC versions are IP67 due to connector)		
<b>Shock Resistance</b>	IEC 68-2-27 11ms 30g		
<b>Vibration Resistance</b>	IEC 68-2-6 10-55 Hz 1mm [0.04 in]		
<b>Cable Type</b>	PVC, 6.5 mm outside diameter max.	PVC, 6.5 mm outside diameter max.	PVC, 6mm [0.24 in] outer diameter max.
<b>Mounting Bolts (recommended)</b>	2 x M4; Tightening torque: 1.0 N•m [0.74 lb•ft]		

Note: Always mount onto non-ferrous materials.

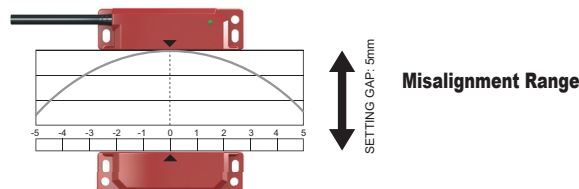

# Safety Products



*Warning: Safety products sold by AutomationDirect are Safety components only. The purchaser/installer is solely responsible for the application of these components and ensuring all necessary steps have been taken to assure each application and use meets all performance and applicable safety requirements and/or local, national and/or international safety codes as required by the application. AutomationDirect cannot certify that our products, used solely or in conjunction with other AutomationDirect or other vendors' products, will assure safety for any application. Any person using or applying any products sold by AutomationDirect is responsible for learning the safety requirements for their individual application and applying them, and therefore assumes all risks, and accepts full and complete responsibility, for the selection and suitability of the product for their respective application.*

*AutomationDirect does not provide design or consulting services, and cannot advise whether any specific application or use of our products would ensure compliance with the safety requirements for any application.*