

ReeR MOSAIC MV Series Speed Monitor Expansion Units



The ReeR MOSAIC (MOdular Safety Integrated Controller) MV Series Safety Speed Monitor expansion units provide the ability to safely monitor speed using proximity switches or encoders.

Features

- All speed monitor expansion units can receive inputs from two proximity switches
- Allows the monitoring of zero speed, max speed, speed range, and motion direction
- Programmable with the Mosaic Safety Designer software
- LED status and fault diagnostic indicators
- Connection to M1 or M1S via MSC 5-way ReeR proprietary bus. Bus connector included.
- Removable terminal block plus screw contacts

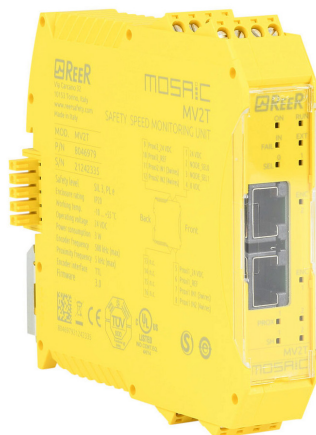

MOSAIC-MV2T

Safety Data per EN 13849-1

Category	4
Performance level	e
MTTF_d (years)	30-100
DC_{avg}	High
Safety Data per IEC/EN 62061, IEC/EN 61508	
SIL CL	3
SIL	3
HFT	1
DC_{avg}	High
SFF	99.8%
PFH_d (t-20a)	Varies – see Specifications table

**Safety data is dependent on circuit architecture.
See manual for further details.**

MOSAIC MV Series Expansion Unit Selection Guide

Part Number	Price	Number of Encoders	Type of Encoder	Number of Proximity Switches	Maximum Number of Axes
MOSAIC-MV0	\$345.00	0	–	2	2
MOSAIC-MV1T	\$522.00	1	TTL (line driver)	2	2
MOSAIC-MV1H	\$442.00	1	HTL (push-pull)	2	2
MOSAIC-MV1S	\$584.00	1	SIN/COS	2	2
MOSAIC-MV2T	\$584.00	2	TTL (line driver)	2	2
MOSAIC-MV2H	\$506.00	2	HTL (push-pull)	2	2
MOSAIC-MV2S	\$725.00	2	SIN/COS	2	2



MOSAIC MV Series Specifications

General Specifications		
Operating Temperature	-10°C to +55°C [14°F to 131°F]	
Storage Temperature	-20°C to +85°C [-4°F to 185°F]	
Altitude	2000m (max)	
Vibration Resistance	Tested to IEC 60068-2-6	
Degree of Protection	IP 20	
Housing	Polyamide	
Weight	240g [8.47 oz]	
Agency Approvals and Standard	cULus, CE, TÜV	
Terminal Designation per EN 50 005	AWG 12-30 solid/stranded. Use 60/75°C copper (Cu) conductor only.	
Wire Fixing	Screw pluggable terminal blocks. Terminal tightening torque 5-7 lb•in (0.6-0.7 N•m).	
Specifications		
Nominal Voltage	24VDC	
Voltage Range	± 20%	
Maximum Consumption	3W	
Maximum Encoder Frequency	500kHz (HTL: 300kHz)	
PFH_d (t-20a)	MOSAIC-MV0	7.48e ⁻⁹
	MOSAIC-MV1T	8.58e ⁻⁹
	MOSAIC-MV1H	8.20e ⁻⁹
	MOSAIC-MV1S	9.43e ⁻⁹
	MOSAIC-MV2T	9.68e ⁻⁹
	MOSAIC-MV2H	8.92e ⁻⁹
	MOSAIC-MV2S	1.14e ⁻⁸

Note: See product manual for complete details.

Note: To obtain the most current agency approval information, see the Agency Approval Checklist section on the specific part number's web page.

Electrical Connections to MOSAIC MVxT Series



- Wire size range: AWG 12-30 (solid/stranded) (UL).
- Use 60/75°C copper (Cu) conductor only.
- Turn off power before making connections.
- The supply voltage must be 24VDC ± 20% (PELV, in compliance with the standard EN 60204-1 (Chapter 6.4).
- Do not use the MOSAIC to supply external devices.
- The same ground connection (0VDC) must be used for all system components.
- Separate power supplies are recommended for the safety module and for other electrical power equipment (electric motors, inverters, frequency converters) or other sources of disturbance.
- Cables used for connections of longer than 50m [164ft] must have a cross-section of at least 1mm² (AWG16).
- TTL (Line Driver) encoders are compatible with the MVxT series.

Dimensions mm [inches]

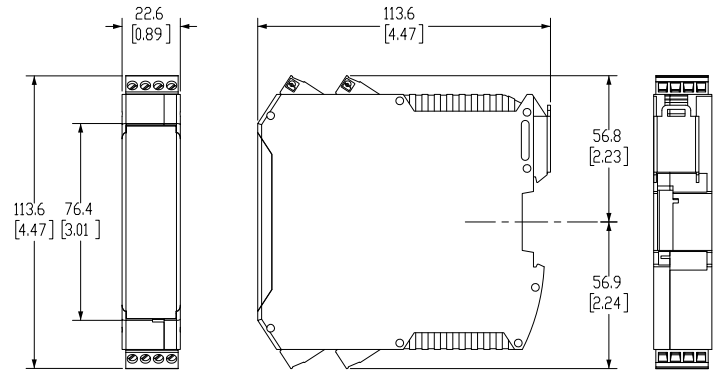

MVxT Terminal Connections				
Terminal	Signal	Type	Operation	Description
1	24VDC	-	-	24VDC power supply
2	NODE_SEL0	Input	-	Node selection
3	NODE_SEL1	Input	-	
4	0VDC	-	-	0VDC power supply
5	PROX1_24V	Output	Power supply 24VDC to PROX1	Proximity 1 connections
6	PROX1_REF	Output	Power supply 0VDC to PROX1	
7	PROX1 IN1 (3 wires)	Input	PROX1 NO input	
8	PROX1 IN2 (4 wires)	Input	PROX1 NC input	
9	PROX2_24V	Output	Power supply 24VDC to PROX2	Proximity 2 connections
10	PROX2_REF	Output	Power supply 0VDC to PROX2	
11	PROX2 IN1 (3 wires)	Input	PROX2 NO input	
12	PROX2 IN2 (4 wires)	Input	PROX2 NC input	
13	Not connected	-	-	-
14	Not connected	-	-	-
15	Not connected	-	-	-
16	Not connected	-	-	-

Please see the ReeR MOSAIC Supplemental Manual for basic wiring examples.

TTL Encoder Connection Diagram

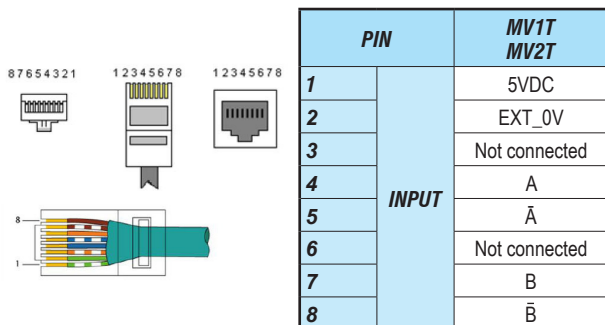



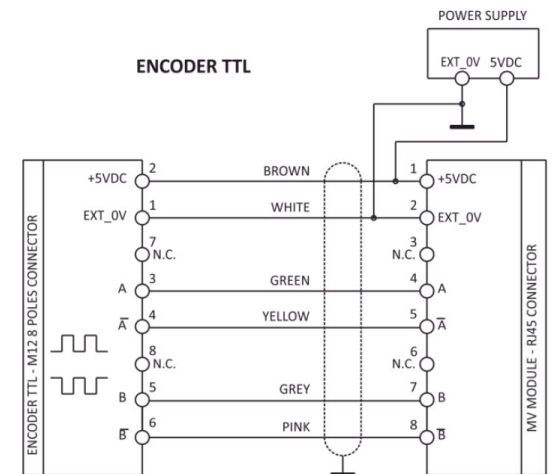









NOTE: All inputs must be utilized. For example, an encoder without the Ā signal will not work. Be sure to select a compatible encoder type.

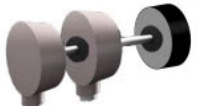

ReeR MOSAIC MV Series Speed Monitor Expansion Units



Configuration-Dependent Safety Levels

Encoder	Proximity	MV Module	Safety Level
 1 Sin/Cos Safety Encoder	---	 MV1	SIL 3 – PL e
 1 Sin/Cos or 1 TTL or 1 HTL Encoder	+ 1 Proximity	 MV1	Cat. 3 - DCavg 90% up to SIL 3 – PL e
---	 2 Proximity	 MV0	Cat. 3 - DCavg 90% up to SIL 3 – PL e
 2 Sin/Cos or 2 TTL or 2 HTL Encoder	---	 MV2	Cat. 3 - DCavg 90% up to SIL 3 – PL e
 1 Sin/Cos or 1 TTL or 1 HTL Encoder	---	 MV1	Cat. B - PL b (Cat. 1 - SIL 1 – PL c under conditions)
---	 1 Proximity	 MV0	Cat. B - PL b (Cat. 1 - SIL 1 – PL c under conditions)

All MV Series Speed Monitor Expansion Units allow for up to 2 axes.

MOSAIC



MODULAR SAFETY INTEGRATED CONTROLLER

The MOSAIC system is a unique safety controller that's modular, expandable and configurable for managing all safety functions of a single machine or an entire plant. It offers cost reductions with minimal wiring.

COMMS



MOSAIC-MBEI

Industrial Fieldbus:
EtherNet/IP.

MOSAIC-MBEM

Industrial Fieldbus:
ModBus TCP/IP.

DIGITAL INPUTS



MOSAIC-MI8

8 digital inputs and four
test outputs.

MOSAIC-MI16

16 digital inputs and
4 test outputs.

MOSAIC-MI12T2

12 digital inputs, 8 test outputs.

I/O EXPANSION UNIT



MOSAIC-MI802

8 digital inputs, 2 EDM/
RST inputs, 4 test outputs,
2 OSSD pairs, and 2 status
outputs.

MOSAIC-MI804

8 digital inputs, 4 test outputs,
4 individual or 2 pair OSSD outputs, and
4 configurable I/O.

SPEED MONITORING

MOSAIC-MV0

2 prox switch inputs.

MOSAIC-MV1T

1 TTL encoder and
2 prox switch inputs.

MOSAIC-MV1H

1 HTL encoder and 2 prox switch inputs.

MOSAIC-MV1S

1 SIN/COS encoder and 2 prox switch inputs.

MOSAIC-MV2T

2 TTL encoder and 2 prox switch inputs.

MOSAIC-MV2H

2 HTL encoder and 2 prox switch inputs.

MOSAIC-MV2S

2 SIN/COS encoder and 2 prox switch inputs.

MOSAIC SYSTEM

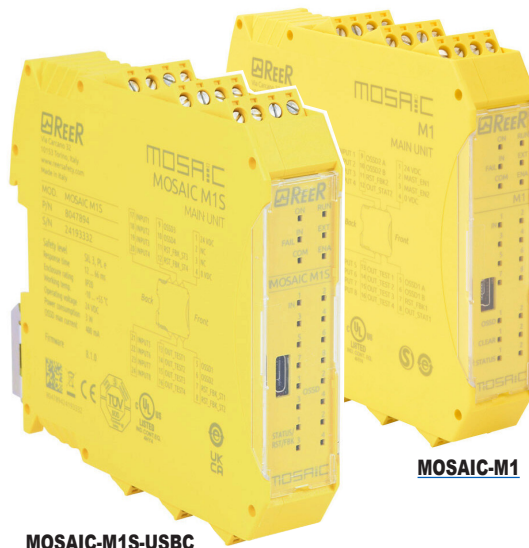

MOSAIC-M1S-USBC

MOSAIC-M1

MOSAIC M1, M1S, or M1S-USBC controller units are able to interface with up to 14 individual expansion modules (up to a maximum of 4 of any one module type).

Controller units can also be used in a stand-alone configuration.

Blue-highlighted modules work only with the **MOSAIC-M1S** or **MOSAIC-M1S-USBC** controller.

SAFETY RELAYS

MOSAIC-MR2

2 relays – 2 NO + 1 NC connectable to 1 OSSD pair + 1 NC contact for external device monitoring. 2 safety relays with guided contacts. Screw contacts.



MOSAIC-MR4

4 relays – 4 NO + 2 NC connectable to 2 OSSD pair + 2 NC contacts for external device monitoring. 4 safety relays with guided contacts. Screw contacts.

These extension relays can connect to the outputs on the **MOSAIC M1, M1S, or to any of the output cards**

DIGITAL OUTPUTS

MOSAIC-MO2

2 EDM/RST inputs, 2
OSSD pairs and 2 status
outputs.



MOSAIC-MO4

4 EDM/RST inputs, 4
OSSD pairs and 4 status outputs.

MOSAIC-MOR4

4 single-channel outputs or 2 dual-channel outputs.

MOSAIC-MOR4S8

4 single-channel outputs or 2 dual-channel outputs with 8 status outputs.

MOSAIC-MO4L

4 individual or 2 pair OSSD outputs,
and 4 configurable I/O.

ANALOG INPUTS

MOSAIC-MA4

4 analog inputs.



STATUS OUTPUTS

MOSAIC-MOS8

8 status outputs.

MOSAIC-MOS16

16 status outputs.



ACCESSORIES

MOSAIC-MSC-C

Safety communication bus connector and terminal end caps. Required to connect additional module to **MOSAIC-M1, MOSAIC-M1S, or MOSAIC-M1S-USBC**.

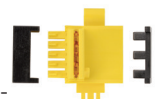

MOSAIC-MCM, MOSAIC-MCMB

A proprietary removable memory card that can be used to save MOSAIC configuration data for subsequent transfer to a new device without using a PC.



Safety Products



Warning: Safety products sold by AutomationDirect are Safety components only. The purchaser/installer is solely responsible for the application of these components and ensuring all necessary steps have been taken to assure each application and use meets all performance and applicable safety requirements and/or local, national and/or international safety codes as required by the application. AutomationDirect cannot certify that our products, used solely or in conjunction with other AutomationDirect or other vendors' products, will assure safety for any application. Any person using or applying any products sold by AutomationDirect is responsible for learning the safety requirements for their individual application and applying them, and therefore assumes all risks, and accepts full and complete responsibility, for the selection and suitability of the product for their respective application.

AutomationDirect does not provide design or consulting services, and cannot advise whether any specific application or use of our products would ensure compliance with the safety requirements for any application.