

3P Series Molded Case Circuit Breakers Overview

Overview

Designed to provide branch and feeder circuit protection in industrial control panels, this line of Molded Case Circuit Breakers supplies protection against overload in conductors and short circuit in connected equipment such as motors. They are UL listed for installation in UL 508 control panels. Their small size, in relation to standard circuit breakers or other comparable devices, saves panel space. Four frame sizes and all standard accessories are available.

Features

- UL489 listed performance for branch circuit overcurrent protection and disconnecting means
- Patented contact conductor designs featuring high-speed "blow-open" action, providing superior performance when high level fault currents produce extra-ordinary electromechanical forces
- Advanced arc extinguishing technology
- Toggle handle provides three positions (on/off/tripped) along with visual indicators
- Manufactured in ISO 9000 certified facilities
- HACR (heating, air conditioning and refrigeration) rated
- G-Frame and F-Frame breakers are suitable for reverse feed
- K-Frame and L-Frame breakers include 3-pole adjustable magnetic trip.

Listings

- UL 489 MCCB, File: E7819
- Field-installed accessories: UL file E64983
- CSA 22.2 No.5, File: 43556
- IEC 157-1
- NEMA Standards Pub. No. AB1-1993



Manufactured by Eaton Corporation

Note: These parts available for sale to North American locations only.

Molded Case Circuit Breakers Technical Specifications										
Circuit Breaker Type	Ampere Rating at 40°C	No. Poles	Volts		Type of Trip*	Federal Specification W-C-375b	UL 489 Interrupting Ratings (rms Symmetrical Amperes) (kA)			
			AC	DC			Volts AC (50/60 Hz)			Volts DC
							240	480	600	
G-Frame	15 -100	3	480	250	N.I.T.U	13b	65	22	-	10
F-Frame	60 - 225	3	600	250	N.I.T.U	22a	65	35	18	10
K-Frame	250 - 400	3	600	250	I.T.U	23a	65	35	25	10
L-Frame	400 - 600	3	600	250	I.T.U	23a	65	35	25	22

*Note: N.I.T.U denotes non-interchangeable trip unit. I.T.U denotes interchangeable trip unit.

**Note: For DC or 1-phase AC applications, use the two outside poles of the 3-pole circuit breaker

Molded Case Circuit Breakers Part Numbering System

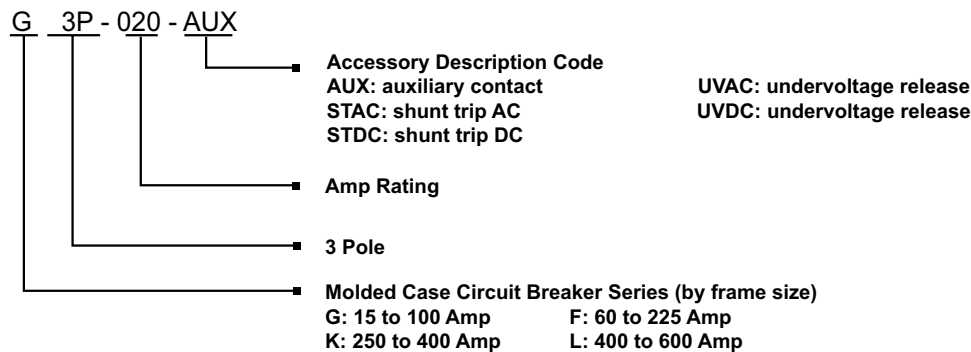

3P Series Molded Case Circuit Breakers

15-100 Amp G-Frame

G-Frame circuit breakers are available as a single unit, or with accessories pre-installed only. Accessories are not field installable on this frame size. G-Frame breakers are suitable for reverse feed use. All breakers include base mounting hardware for panel mount applications.



G3P-040



GHMVD12B



F0S03C



3TA100G6K



GDIN

G-Frame Series Three Pole Molded Case Circuit Breakers						
Part Number	Price	Description	Pre-Installed Accessories*	Ampere Rating	Voltage	Interrupt Capacity
G3P-015	\$428.00	Molded case circuit breaker with non-adjustable thermal magnetic trip; line and load lug terminals included.	None	15	240VAC 480VAC	65kA 22kA 10kA
G3P-015-AUX	\$509.00		With auxiliary contact, SPDT			
G3P-020	\$428.00	Molded case circuit breaker with non-adjustable thermal magnetic trip; line and load lug terminals included.	None	20		
G3P-020-AUX	\$509.00		With auxiliary contact, SPDT			
G3P-025	\$428.00	Molded case circuit breaker with non-adjustable thermal magnetic trip; line and load lug terminals included.	None	25		
G3P-030	\$428.00		None			
G3P-030-AUX	\$509.00	Molded case circuit breaker with non-adjustable thermal magnetic trip; line and load lug terminals included.	With auxiliary contact, SPDT	30		
G3P-030-STAC	\$509.00		With 120 VAC shunt trip			
G3P-030-STDC	\$509.00		With 24 VDC shunt trip			
G3P-030-UVAC	\$509.00		With 120 VAC undervoltage release			
G3P-040	\$428.00	Molded case circuit breaker with non-adjustable thermal magnetic trip; line and load lug terminals included.	None	40		
G3P-050	\$428.00		None	50		
G3P-060	\$428.00		None	60		
G3P-060-AUX	\$509.00	With auxiliary contact, SPDT				
G3P-060-STAC	\$509.00	With 120 VAC shunt trip				
G3P-060-STDC	\$509.00	With 24 VDC shunt trip				
G3P-060-UVAC	\$509.00	Molded case circuit breaker with non-adjustable thermal magnetic trip; line and load lug terminals included.	With 120 VAC undervoltage release	70		
G3P-070	\$428.00		None			
G3P-080	\$428.00		None		80	
G3P-090	\$428.00	Molded case circuit breaker with non-adjustable thermal magnetic trip; line and load lug terminals included.	None	90		
G3P-100	\$428.00		None	100		
G3P-100-AUX	\$509.00		With auxiliary contact, SPDT			
G3P-100-STAC	\$509.00		With 120 VAC shunt trip			
G3P-100-STDC	\$509.00	With 24 VDC shunt trip				
G3P-100-UVAC	\$509.00	With 120 VAC undervoltage release				

*Note: Available accessories are pre-installed on G-Frame and F-Frame Molded Case Circuit Breakers. They are not field installable or interchangeable. G-frame terminals are factory-installed only. No replacement terminals available.

** For DC or 1-phase AC applications, use the two outside poles of the 3-pole circuit breaker

G-Frame Accessory Selection Guide		
Part Number	Price	Description
GHMVD06B	\$110.00	NEMA 1/12 rotary handle for G-Frame. Position indicating; lock-off feature. Shaft length: 6"
GHMVD12B	\$123.00	NEMA 1/12 rotary handle for G-Frame. Position indicating; lock-off feature. Shaft length: 12"
F0S03C	\$473.00	NEMA 1/12 flex shaft cable operator for G-Frame. Flange mounted. Lockable. Cable length: 3'
F0S06C	\$529.00	NEMA 1/12 flex shaft cable operator for G-Frame. Flange mounted. Lockable. Cable length: 6'
3TA100G6K	\$87.00	Multi-wire connector to allow 6 wires to be connected to the G-frame. UL for copper only. 14-6AWG. Package of 3
GDIN	\$15.00	DIN rail clip adapter to allow mounting of G-Frame unit on 35mm DIN rail. Pkg of 1 includes mounting hardware.

AWG Wire Range Specifications				
Circuit Breaker	Ampere Rating	Wire Type	AWG Wire Range	Metric Wire Range mm ²
G-Frame	15 - 20	Cu/Al	14 - 10	2.5 - 4
	25 - 100		10 - 1/0	4 - 50

G-Frame Electrical Ratings					
	Volts	Frequency	Amperes	Contact Arrangement	
G-Frame Auxiliary Switch	240 VAC	50/60 Hz	6	1a/1b - SPDT	
G-Frame Shunt Trip	120 VAC	50/60 Hz	1.1		
	24 VDC	DC	5.7		
G-Frame Undervoltage Release Mechanism	120 VAC	50/60 Hz	0.05	Dropout Voltage	
	Pickup Voltage				
	Min	Max	Max		
	38.5 VAC	77.0 VAC	93.5 VAC		

3P Series Molded Case Circuit Breakers 15-100 Amp G-Frame

Type G3P 15-100 Amperes 3 Pole

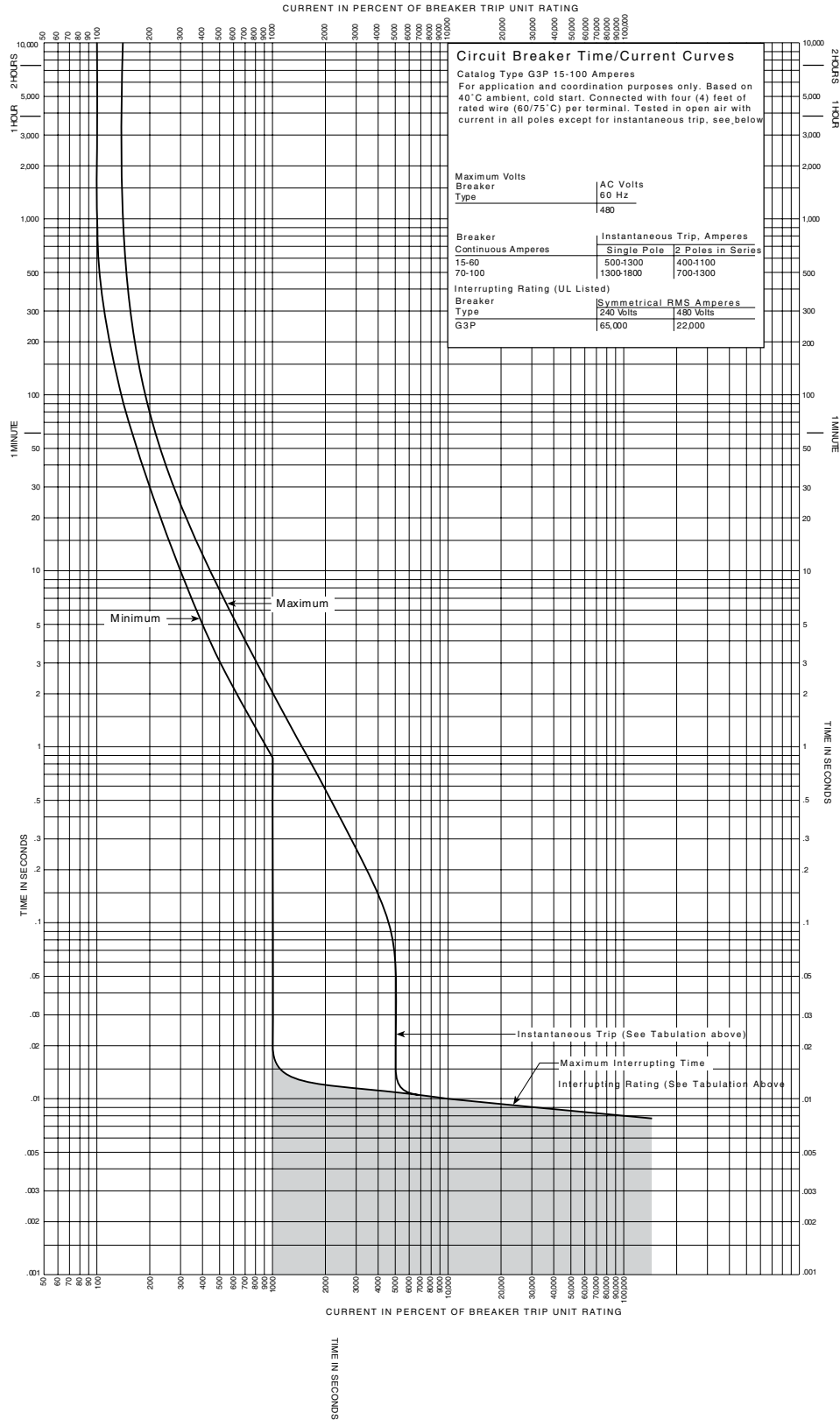

3P Series Molded Case Circuit Breakers

Dimensions

Dimensions

mm [inches]

15 - 100 Amp G-Frame

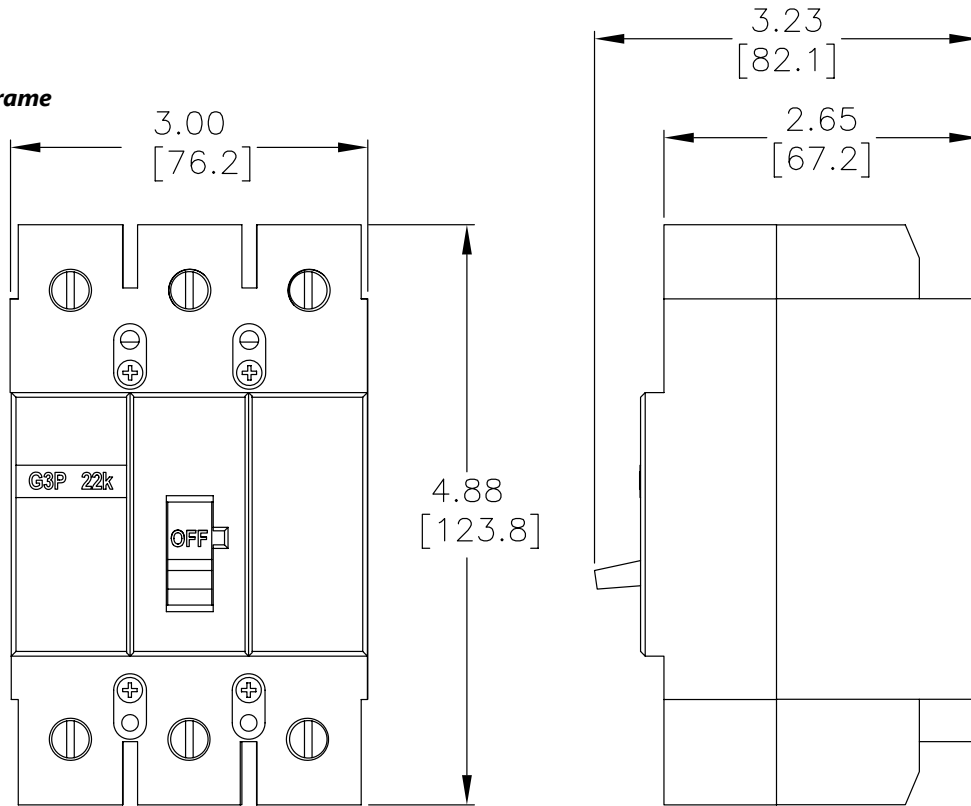

60 - 225 Amp F-Frame

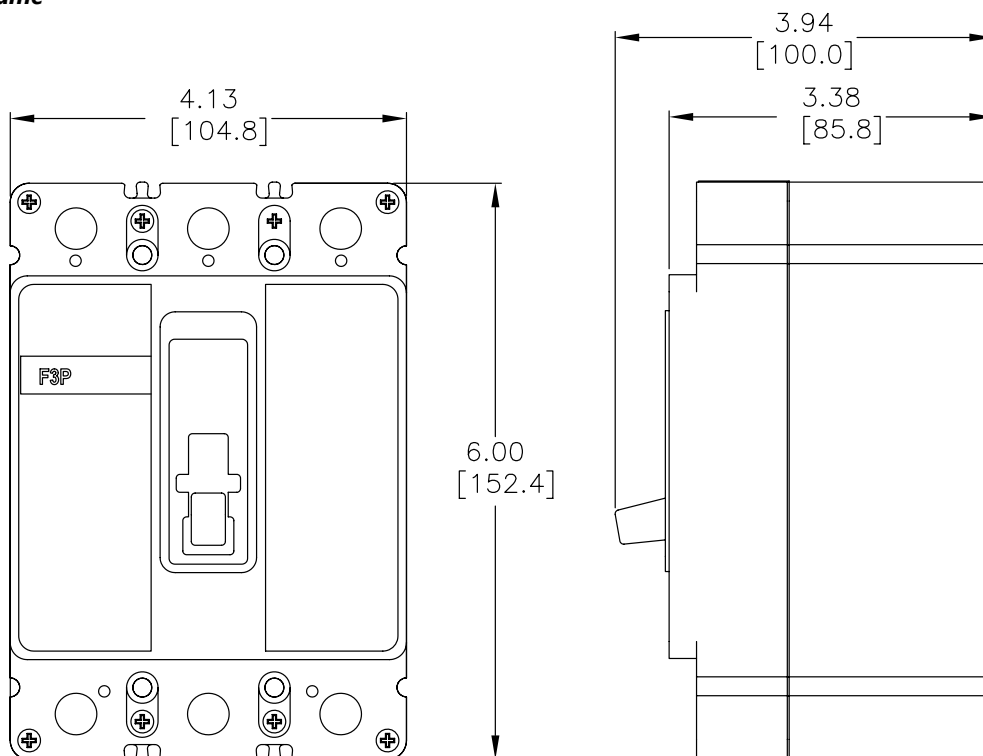

3P Series Molded Case Circuit Breakers

Accessories

Field Mountable Accessories



[GHMVD12B](#)



[HM1R12X](#)

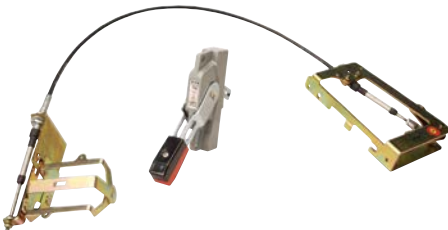

[F0S03C](#)

Rotary Handles

A rotary handle is available for each frame size of molded case circuit breaker.

The C-Series rotary handle (HM) is available for F, K, & L frame molded case breakers. These robust and durable handles include the following features:

- Suitable for use with NEMA 4/4X enclosures
- Handle, shaft, and mechanism made from all metal parts
- Large handle easily accommodates gloves
- Heavy Duty Metal locking hasp
- Door interlock and defeater
- Standard ON/OFF/Trip markings and a 45-degree rotation
- UL 489, CSA

The Universal rotary series handles (HMV) is available for G, F, K, & L frame molded case breakers. These handles include the following features:

- Suitable for use with NEMA 1/12 enclosures
- Composite Nylon handle with metal shaft, and mechanism
- Large handle easily accommodates gloves
- Access Handle Lock-Off by pressing arrow on handle insert
- Door interlock and defeater
- Global ON/OFF markings (I/ON, O/OFF) and TRIP indication on handle plus 90-degree rotation
- UL 489, IEC 947-1/-2, CSA

Rotary Handle Accessory Selection Guide

Part Number	Price	Description
GHMVD06B	\$110.00	NEMA 1/12 black rotary handle for G-Frame MCCB. Shaft length: 6in [152.4 mm]
GHMVD12B	\$123.00	NEMA 1/12 black rotary handle for G-Frame MCCB. Shaft length: 12in [304.8 mm]
FHMVD12B	\$123.00	NEMA 1/12 black rotary handle for F-Frame MCCB. Shaft length: 12in [304.8 mm]
HM1R12X	\$173.00	NEMA 4/4X black rotary handle for F-Frame MCCB. Shaft length: 12in [304.8 mm]
HM1R24X	\$194.00	NEMA 4/4X black rotary handle for F-Frame MCCB. Shaft length: 24in [609.6 mm]
KHMVD12B	\$175.00	NEMA 1/12 black rotary handle for K-Frame MCCB. Shaft length: 12in [304.8 mm]
HM3R12X	\$212.00	NEMA 4/4X black rotary handle for K-Frame MCCB. Shaft length: 12in [304.8 mm]
HM3R24X	\$237.00	NEMA 4/4X black rotary handle for K-Frame MCCB. Shaft length: 24in [609.6 mm]
LHMVD12B	\$202.00	NEMA 1/12 black rotary handle for L-Frame MCCB. Shaft length: 12in [304.8 mm]
HM4R12X	\$276.00	NEMA 4/4X black rotary handle for L-Frame MCCB. Shaft length: 12in [304.8 mm]
HM4R24X	\$292.00	NEMA 4/4X black rotary handle for L-Frame MCCB. Shaft length: 24in [609.6 mm]

Flex Shaft™ Flexible Handle

Meeting crucial time limits for shutdown procedures is easier with an externally mounted handle. The flexible handle makes it possible to operate the circuit breaker externally and can be used in enclosures of varying depths and heights. It can be used with NEMA 1, NEMA 3R and NEMA 12 enclosures, and it accepts up to three padlock shackles. Each item includes a painted steel handle, breaker operating mechanism, and cable.

Note: A minimum bending radius of four inches is necessary for proper operation.

Flex Shaft™ Flexible Handle Accessory Selection Guide

Part Number	Price	Description
F0S03C	\$473.00	NEMA 1/12 flex shaft cable operator for G-Frame MCCB. Cable length: 3ft [0.91 m]
F0S06C	\$529.00	NEMA 1/12 flex shaft cable operator for G-Frame MCCB. Cable length: 6ft [1.83 m]
F1S03C	\$529.00	NEMA 1/12 flex shaft cable operator for F-Frame MCCB. Cable length: 3ft [0.91 m]
F1S06C	\$573.00	NEMA 1/12 flex shaft cable operator for F-Frame MCCB. Cable length: 6ft [1.83 m]
F3S03C	\$631.00	NEMA 1/12 flex shaft cable operator for K-Frame MCCB. Cable length: 3ft [0.91 m]
F3S06C	\$662.00	NEMA 1/12 flex shaft cable operator for K-Frame MCCB. Cable length: 6ft [1.83 m]
F4S04C	\$721.00	NEMA 1/12 flex shaft cable operator for L-Frame MCCB. Cable length: 4ft [1.22 m]
F4S06C	\$829.00	NEMA 1/12 flex shaft cable operator for L-Frame MCCB. Cable length: 6ft [1.83 m]

3P Series Molded Case Circuit Breakers

Accessories



High Performance Flex Shaft™ Flange Handles

These two-position flange handles feature external front mounting. Models are available for NEMA 1/3R/12 and 4/4X enclosures and for G-frame, F-frame, K-frame or L-frame model MCCBs. All models are lockable in the OFF position and are defeatable. The Flex Shaft handle will accept up to three padlock shackles, each with a maximum diameter of 0.375 in [9.5 mm]. Each item includes a high-strength nylon handle, breaker operating mechanism, and cable.

Flange Handle Accessory Selection Guide

Part Number	Price	Description
F0S03HP	\$309.00	3ft [0.91 m] cable length, NEMA 1/3R/12. For use with G-frame model MCCBs.
F0S06HP	\$352.00	6ft [1.83 m] cable length, NEMA 1/3R/12. For use with G-frame model MCCBs.
F1S03HP	\$352.00	3ft [0.91 m] cable length, NEMA 1/3R/12. For use with F-frame model MCCBs.
F1S06HP	\$379.00	6ft [1.83 m] cable length, NEMA 1/3R/12. For use with F-frame model MCCBs.
F3S03HP	\$429.00	3ft [0.91 m] cable length, NEMA 1/3R/12. For use with K-frame model MCCBs.
F3S06HP	\$450.00	6ft [1.83 m] cable length, NEMA 1/3R/12. For use with K-frame model MCCBs.
F4S04HP	\$504.00	4ft [1.22 m] cable length, NEMA 1/3R/12. For use with L-frame model MCCBs.
F4S06HP	\$580.00	6ft [1.83 m] cable length, NEMA 1/3R/12. For use with L-frame model MCCBs.
F0S03HPX	\$340.00	3ft [0.91 m] cable length, NEMA 4/4X. For use with G-frame model MCCBs.
F0S06HPX	\$387.00	6ft [1.83 m] cable length, NEMA 4/4X. For use with G-frame model MCCBs.
F1S03HPX	\$387.00	3ft [0.91 m] cable length, NEMA 4/4X. For use with F-frame model MCCBs.
F1S06HPX	\$418.00	6ft [1.83 m] cable length, NEMA 4/4X. For use with F-frame model MCCBs.
F3S03HPX	\$473.00	3ft [0.91 m] cable length, NEMA 4/4X. For use with K-frame model MCCBs.
F3S06HPX	\$496.00	6ft [1.83 m] cable length, NEMA 4/4X. For use with K-frame model MCCBs.
F4S04HPX	\$543.00	4ft [1.22 m] cable length, NEMA 4/4X. For use with L-frame model MCCBs.
F4S06HPX	\$625.00	6ft [1.83 m] cable length, NEMA 4/4X. For use with L-frame model MCCBs.

Note: A minimum bending radius of four inches is necessary for proper operation.

3P Series Molded Case Circuit Breakers Accessories

Field Mountable Accessories

Auxiliary Contact

The auxiliary contact provides circuit breaker contact status information by monitoring the position of the molded cross bar which contains the moving contact arms. The auxiliary switch is used for remote indication and interlock system verification, and consists of one SPDT switch housed in a plug-in module. Each SPDT switch has one 'a' and one 'b' contact. When the circuit breaker contacts are open, the 'a' contact is open and the 'b' contact is closed.

Note: Field installable auxiliary contacts are not available for the G and F frame breakers.

For G and F frame auxiliary contacts, order breakers with -AUX as part of the part number. Please see G and F-frame sections for available selections.

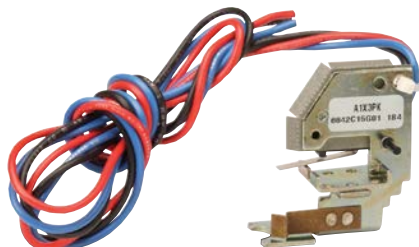

A1X3PK

Auxiliary Contact Accessory Selection Guide		
Part Number	Price	Description
A1X3PK	\$310.00	Field installable auxiliary contact for K-Frame MCCB, SPDT, 18" pigtail leads
A1X4PK	\$318.00	Field installable auxiliary contact for L-Frame MCCB, SPDT, 18" pigtail leads

K-Frame Electrical Ratings ^{1,2}					
	Max Volts	Frequency	Max Amperes	Dielectric Withstand Voltage	Notes
K-Frame Auxiliary Switch	600	50/60 Hz	6	2500	1. Endurance: 5000 electrical operations plus 1000 mechanical operations. 2. Pigtail wire size: 18 AWG (0.82 mm ²) 3. Non-inductive load
	125	DC	0.50 ³		
	250	DC	0.25 ³		

L-Frame Electrical Ratings ^{1,2}					
	Max Volts	Frequency	Max Amperes	Dielectric Withstand Voltage	Notes
L-Frame Auxiliary Switch	600	50/60 Hz	6	2500	1. Endurance: 5000 electrical operations plus 1000 mechanical operations. 2. Pigtail wire size: 18 AWG (0.82 mm ²) 3. Non-inductive load
	125	DC	0.50 ³		
	250	DC	0.25 ³		

Undervoltage Release

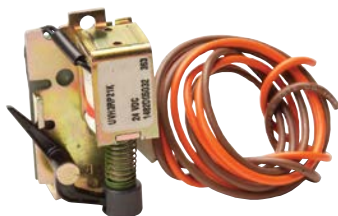

UVH3LP21K

This product monitors a voltage (typically a line voltage) and trips the circuit breaker when the voltage falls to between 70% and 35% of the solenoid coil rating. It consists of a continuous rated solenoid, with a plunger and tripping lever mounted in a plug-in module.

Note: The undervoltage release is a pre-installed accessory on G-Frame and F-Frame breakers.

Undervoltage Release Accessory Selection Guide		
Part Number	Price	Description
UVH3LP08K	\$481.00	Field installable 110 - 127 VAC undervoltage release for K-Frame MCCB
UVH4LP08K	\$513.00	Field installable 110 - 127 VAC undervoltage release for L-Frame MCCB
UVH3LP21K	\$481.00	Field installable 24 VDC undervoltage release for K-Frame MCCB
UVH4LP21K	\$550.00	Field installable 24 VDC undervoltage release for L-Frame MCCB

K-Frame Undervoltage Release Mechanism	Supply Voltage	Dropout Voltage		Pickup Voltage	VA	Notes
		Min	Max	Max		
	24 VDC	8.4	16.8	20.4	3.1	1. Endurance: 5000 electrical operations plus 1000 mechanical operations. 2. 50/60 Hz
	110 VAC ²				1.8	
	120 VAC ²	44.5	77.0	93.5	2.1	
	127 VAC ²				2.4	

L-Frame Undervoltage Release Mechanism	Supply Voltage	Dropout Voltage		Pickup Voltage	VA	Notes
		Min	Max	Max		
	24 VDC	8.4	16.8	20.4	3.1	1. Endurance: 5000 electrical operations plus 1000 mechanical operations. 2. 50/60 Hz
	110 VAC ²				1.8	
	120 VAC ²	44.5	77.0	93.5	2.1	
	127 VAC ²				2.4	

3P Series Molded Case Circuit Breakers Accessories

Field Mountable Accessories

Shunt Trip

The Shunt Trip provides remote controlled tripping of the circuit breaker. Consisting of an intermittent rated solenoid with a tripping plunger and a cutoff switch assembled to a plug-in module, shunt trip coils are designed to be applied at specific AC or DC voltages.



SNT3P04K

Shunt Trip Accessory Selection Guide		
Part Number	Price	Description
SNT3P11K	\$481.00	Field installable 110/240 VAC / 110/125 VDC shunt trip for K-Frame MCCB.
SNT4RP11K	\$550.00	Field installable 110/240 VAC shunt trip for L-Frame MCCB
SNT3P04K	\$481.00	Field installable 12/24 VAC/DC shunt trip for K-Frame MCCB
SNT4RP03K	\$550.00	Field installable 12/24 VAC/DC shunt trip for L-Frame MCCB

K-Frame Shunt Trip	Supply Voltage	Min Operating Voltage	VA	Supply Voltage	Min Operating Voltage	VA	Notes
	VAC 50/60 Hz			VDC			
	12	9	45	12	8.4	35	
24	200		24	170			
	60	110	100	110	77	110	
		120	120	120	77	130	
		127	140	125	77	140	
		208	420	-	-	-	
		220	470	-	-	-	
		240	550	-	-	-	

1. Endurance: 5000 electrical operations plus 1000 mechanical operations.
2. Approx. unlatching time: 6 ms
Approx. total circuit breaker contact opening time: 8 ms

L-Frame Shunt Trip	Supply Voltage	Min Operating Voltage	VA	Supply Voltage	Min Operating Voltage	VA	Notes
	VAC 50/60 Hz			VDC			
	12	9	45	12	9	35	
24	200		24	170			
	60	110	100	-	-	-	
		120	120	-	-	-	
		127	140	-	-	-	
		208	420	-	-	-	
		220	470	-	-	-	
		240	550	-	-	-	

1. Endurance: 5000 electrical operations plus 1000 mechanical operations.
2. Approx. unlatching time: 6 ms
Approx. total circuit breaker contact opening time: 18 ms

3P Series Molded Case Circuit Breakers

Accessories

Field Mountable Accessories

Six-wire Connector

This is a field installable multi-wire connector which allows six wires to be connected to the load side (OFF) end terminals. It is used to distribute the load from the circuit breaker to multiple devices without the use of separate distribution terminal blocks. UL listed for copper only as used on the load side (OFF) end. Includes mounting hardware, insulators and tin-plated aluminum connectors.



3TA100G6K

Six-wire Connector Accessory Selection Guide

Part Number	Price	Description
3TA100G6K	\$87.00	For G-Frame MCCBs. Pkg. of 3. Wire size: 14 - 6 AWG, copper
3TA150F6K	\$87.00	For F-Frame MCCBs. Pkg. of 3. Wire size: 14 - 6 AWG, copper

Multi-Wire Box Type Wiring Lug

These multi-wire lugs allow for cost and space savings within a panel and allow for improved short-circuit ratings by eliminating the need for power distribution blocks. Designed for load-side mounting. Choose for G-frame, F-frame, or K-frame model MCCBs. Mounting hardware and insulators included. Package of 3.



3TA100G3K

Multi-Wire Box Type Wiring Lug Selection Guide

Part Number	Price	Description
3TA100G3K	\$72.00	100A, 3 openings, #14-2 AWG copper only. For use with G-frame model MCCBs.
3TA150F3K	\$80.00	225A, 3 openings, #14-2 AWG copper only. For use with F-frame model MCCBs.
3TA400K3K	\$161.00	400A, 3 openings, #14-2/0 AWG copper only. For use with K-frame model MCCBs.
3TA400K6K	\$161.00	400A, 6 openings, #14-3 AWG copper only. For use with K-frame model MCCBs.

Replacement Lug Kit

Line and load terminals provide wire connecting capabilities for specific ranges of continuous current ratings and wire types. Replacement lugs will accept wire types Cu/Al as standard.

Replacement Lug Kit Accessory Selection Guide

Part Number	Price	Description
3TA225FD	\$129.00	Replacement lug kit for F-Frame MCCB. Wire range (1) #4-4/0 (25-95 mm ²). Package of (3) terminals.
3TA401K	\$135.00	Replacement lug kit for K-Frame MCCB. Wire range (2) 2/0-250 kcmil or (1) 2/0-500 kcmil (70-240 mm ²). 3-pole kit (one terminal per pole and one terminal cover).
3TA603LDK	\$166.00	Replacement lug kit for L-Frame MCCB. 3-pole kit (one terminal per pole and one terminal cover). Wire range 400-500 AWG (185-240 mm ²), 2 conductors.

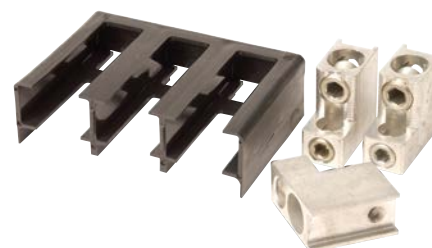

3TA401K

Note: G-frame terminals are factory-installed only. No replacement terminals available.

Din Rail Mounting Clip

Din Rail Mount Clip Accessory Selection Guide

Part Number	Price	Description
GDIN	\$15.00	Clip for mounting G-Frame to 35 mm Din rail. Mounting hardware included. Pkg of 1



GDIN

3P Series Molded Case Circuit Breakers Accessories

Field Mountable Accessories

NEMA 12 Safety Door Hardware

Type C361 door interlocking safety handle kits are designed for use with AutomationDirect 3P series MCCBs and flexible handle when mounted in an SDN12, or equivalent, enclosure. These handles secure the SDN12 enclosure, protecting against unauthorized entry while the MCCB is in the ON position. Use them on enclosures with right-side flanges only and material thickness from 16 gauge through 3/16 in. All mounting hardware is included for enclosures up to 40in [101.6 cm] tall. The addition of the C361KR roller kit is necessary for enclosures taller than 40in [101.6 cm] that require a 3-point latch. See SDN12 Enclosures section for enclosure specifications.

Safety Door Hardware Selection Guide		
Part Number	Price	Description
<u>C361KJ4</u>	\$360.00	Handle length: 4in [10.16 cm]. Mounting hardware included for enclosures up to 40in [101.6 cm] tall. For taller enclosures that require a 3-point latch, the C361KR (purchase separately) will also be needed.
<u>C361KJ6</u>	\$378.00	Handle length: 6in [15.24 cm]. Mounting hardware included for enclosures up to 40in [101.6 cm] tall. For taller enclosures that require a 3-point latch, the C361KR (purchase separately) will also be needed.
<u>C361KR</u>	\$77.00	Door interlocking safety roller kit for use with the C361KJ4 and C361KJ6 safety handle kits when the SDN12 series enclosure is taller than 40in [101.6 cm] and 3-point latching is required. Kit includes roller and all hardware.

Note: The 1/4" x 1/2" standard mill rectangular locking bar is not supplied with these kits. The bar is supplied with the enclosures.



Safety Handle shown on enclosure