



L7P Series AC Servo Systems

Drive features

- Power: 100W–7.5 kW three-phase 230VAC/460VAC
100W–2.2 kW single-phase 230VAC capable
- Fully digital control with up to 1kHz velocity loop response
- Easy setup and diagnostics with DriveCM PC-based software
- Field upgradeable firmware ensures the drive can always be upgraded to the latest operating system
- Command options include:
 - $\pm 10V$ torque or velocity command
 - Pulse train or master encoder position command (accepts line driver or open collector)
 - Internal Indexer for position/speed-based moves include the option for simple registration correction. 64 individual move statements can be configured in the drive. Each Index contains its own distance, speed, accel, decel, and dwell parameters. These indexes can be set up through DriveCM software or modified in real-time with serial communication (PLC, HMI, etc.). The indexes can be initiated via Digital Inputs or through serial comms.
- The 1 kHz bandwidth allows for high-level automatic tuning. Several modes of tuning are available including Off-Line Auto Tuning (the drive initiates its own move commands while Auto tuning), On-Line Auto Tuning (an external controller sends the move commands while the drive Auto tunes), and Manual Tuning (all tuning values are adjusted by the user).
- (16) Optically isolated digital inputs and (8) general purpose (user configurable) outputs, analog inputs for speed and torque control (2), and line driver and open collector output for encoder (with scalable resolution). Two configurable analog outputs for monitoring various servo parameters (actual speed, torque, current, position, etc.)
- Advanced Scope feature that can monitor a variety of command and status signals, including output speed, torque, power, etc.



Motor features

- Low and Medium inertia motors available:
 - Low: 100W, 200W, 400W, 750W, 900W, 1kW, and 1.5 kW; @5000rpm
 - Medium: 1.6 kW, 2.2 kW, 3.5 kW, 5.5 kW, and 7.5 kW; @3000rpm
- Permanent magnet 3-phase synchronous motor
- Keyed drive shafts support clamp-on style couplings or key-style couplings
- Integrated multi-turn absolute encoder with 19-bit resolution (524,288 pulses per revolution)
- Optional 24 VDC spring-set holding brakes (AMK2 and DMK2 motors)
- Standard hook-up cables for motor power, encoder, and brake (separate brake cable for FBL/FCL brake motors)
- Motor cables available in standard or flex-rated lengths of 3, 5, 10, and 20m
- Standard 50-pin DIN-rail mounted break-out kit for the drive's CN1 connector (with screw terminal connections), or 50-pin cables with flying leads

Note: These parts available for sale to North American locations only.

Tuning Technology

The L7P drive closes the loop on current, velocity, and position (depending on control mode selection). The 1kHz bandwidth in the drive assures precise speed and current control and easy tuning. Proportional gain, integral gain and compensation, feed forward compensation, command low pass filter, and four (4) notch filters for resonance suppression are available. Auto Tuning has been greatly improved and can tune motors up to 20:1 inertia mismatch.

There is an inertia estimation function that analyzes the motor and load to measure how much inertia is coupled to the motor.

The drive has several tuning methods available:

- Online Auto Tuning—the drive can either tune the load live while an external controller moves the load to different positions or using the drive's internal tuning motion profile.
- Offline Auto Tuning—the drive tunes the load using the drive's internal tuning motion profile.
- Manual Tuning—all parameters are available to give power users the ultimate flexibility to tune their systems.

Built-in Indexer

While the L7P drives can accept traditional commands from host controllers, they can also provide their own internal motion control. 64 point-to-point position moves can be configured in the drive. These moves can be populated through the DriveCM configuration software or they can be written to by a PLC through the drive's RS422/485 serial port. The moves can be initiated by digital inputs or by serial commands and include the ability to handle simple registration, and can be sequenced internally with delays in between the moves or moves can be linked together so they are processed one after the other.

Multi-axis systems can be controlled via digital inputs, or serial communication. The motion can be commanded from a powerful external controller that sends out high speed pulses to each drive, or the motion can be initiated by a low-level controller (the simplest CLICK PLC) since each drive has a powerful indexer inside. Applications include press feeds, auger fillers, rotary tables, robots for pick and place, test or assembly operations, drilling, cutting, tapping, and similar applications using simple index moves for single or multi-axis motion.

Optional Holding Brake

Each L7P motor can be ordered with an optional 24VDC spring-set holding brake that holds the motor in place when power is removed.

LS Electric MSS Series In-Line Planetary Precision Gearboxes for Servo Motors

Need more torque from the motor? Have an inertia balancing issue in your design? The LS Electric MSS series gearboxes easily mate to FBL/FCL/FE/FF motors. Everything you need for mounting is included!

- Three gear ratios available (5:1, 10:1, 20:1*)
- Mounting hardware included for attaching to FBL/FCL/FE/FF motors.
- Industry-standard mounting dimensions
- Thread-in mounting style
- Very low backlash: 7 arc-min single stage (5:1 and 10:1 ratios), 9 arc-min two-stage (20:1 ratios*).
- 1-year warranty



** The available gearbox ratios for the 7.5 kW motors are 5:1, 10:1, and 15:1, but the features are otherwise equivalent.*



L7P Series AC Servo Systems

Servo drive overview

DC Bus Charge LED

Visual indication of the drive's DC bus voltage level. Do not work on the drive until the Charge LED is OFF.

Motor Power Terminal

Incoming single or three phase 200-230 VAC or three phase 380-480 VAC, model dependent. (-15% to +10%, 50/60Hz)

Regenerative Resistor Terminal

Connection for optional external braking resistor

Control Power Terminal

Incoming single phase 200-230 VAC (or 380-480 VAC for "PB" models)(-15% to +10%, 50/60Hz)

Motor Output Terminal

Output power to the servo motor. LS motor power cables available in 3, 5, 10, and 20 meter lengths in standard and flexing cables.

Model Number

Clearly displayed on bottom of drive face for easy identification.

LED Display

The 5-digit display is used to indicate servo status and alarm.

DIPswitch #2

120Ω terminating resistor for the RS422/RS485 network (use at the end of a multi-drop network)

Analog Connector

4-pin analog monitoring connector (two +/- 10V analog outputs). See L7P-CON-F and L7P-CON-G for optional connectors

Rotary DIPswitch (0-15)

Sets RS422/485 comms station ID. Switch #3 adds 16 to the Node ID (so total addressable Node IDs = 0-31)

USB Connector

Used by Drive CM software for servo configuration. Connect with a standard USB A to USB mini-B cable (SV2-PGM-USB15, MOSAIC-CSU, or similar).

Firmware Upgrade: Use DriveCM software or attach a USB thumb drive with the new FW and update using USB On the Go (no PC required). See the UM for details.

RJ45 Connectors

Serial Modbus RS422 (compatible with RS485 PLCs). Use standard ethernet cables (not crossover cables) to connect multiple drives in a serial network.

CN1 I/O Signal Connector

50-pin CN1 connector for drive I/O. Signals include high speed pulse inputs, 16 digital inputs, 8 digital outputs, 2 analog inputs (voltage and torque), and scalable encoder output.

Encoder Connector

14-pin CN2 connector for the motor encoder. LS Encoder cables available in 3, 5, 10, and 20 meter lengths in standard and flexing cables.



The LS Electric L7P servo drives are fully digital and include over 300 parameters to configure the drive for almost any application. For convenience, the parameters are grouped into several categories including:

- Basic parameters
- Gain parameters
- I/O parameters
- Velocity parameters
- Misc. parameters
- Monitor parameters
- Index parameters

All parameters have commonly used default values which allow you to operate the L7P drive "out-of-the-box". The drive auto-detects the

LS servo motor (through the serial encoder) and sets up the default gains and limits based on the connected motor.

The drive can still be easily configured to your specific application, however. The Drive CM configuration software has a built-in Setup Wizard that will guide you through all the basic setup parameters. So, whether you want to use high speed pulse input, analog velocity, analog torque, or the powerful internal indexer for a control mode (or any multi-mode combination of these modes), the Setup Wizard will quickly and easily get your application started – from setting up the I/O to determining the appropriate homing sequence.

After configuration is complete, the Auto Tune features of the drive will get your application tuned for optimal responsiveness and performance.



L7P/iX7NH AC Servo Systems

Servo motor overview

Encoder Connector

9-pin watertight connector for the 19-bit serial encoder. The encoder transmits motor/encoder identification information to the drive at power-up and it sends position feedback during operation.

Brake Power Connector

2-pin watertight connector available on FBL/FCL brake motors only. The 24VDC brake is located between the motor coils and the encoder. Motors ending in AMK2 and DMK2 have brakes. The brakes must have 24VDC applied to them before the motor is set in motion.

Low Inertia Motors

Low inertia designs (AMK series) result in high responsiveness at high speeds for lighter loads.

- 100–100W motors available
- 60 and 80 mm flanges

FBL/FCL Series Motor

Motor Power Connector

4-pin watertight connector for motor power (U, V, W, and ground)

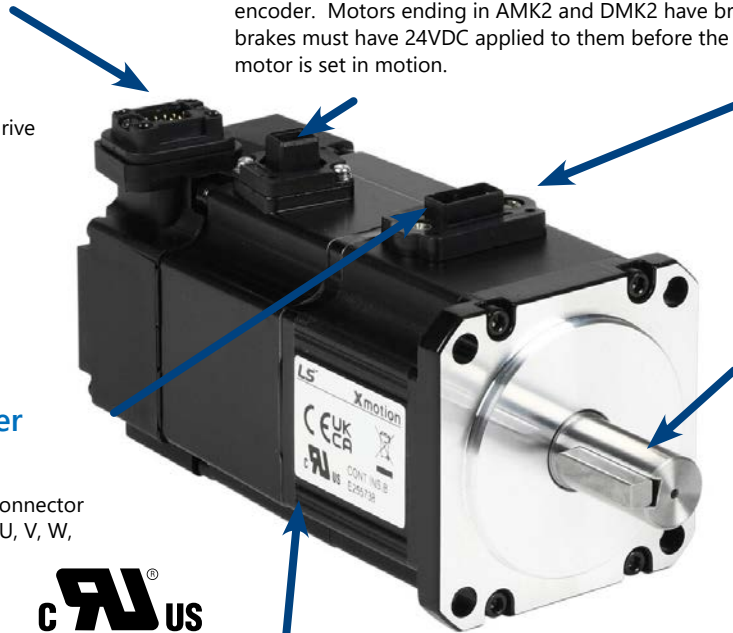

IP67 Housing

Keyed Shafts

FBL and FCL motors are supplied with extra-large keyways, and slightly oversized keys which may need to be "fitted" into the keyway for performance and longevity. Clamp or compression couplings (without key) are recommended.

- 100W 14mm diameter shaft
- 200W 14mm diameter shaft
- 400W 14mm diameter shaft
- 750W 19mm diameter shaft
- 1000W 19mm diameter shaft

All LS Electric FBL/FCL/FE/FF motors have keyed shafts for use with servo-grade clamp or compression couplings (recommended) or servo-grade keyed couplings. Some sanding/filing of the key may be required before pressing into the keyway. Do not modify the shaft/keyway.

Encoder Connector

17-pin watertight connector for the 19-bit serial encoder. The encoder transmits motor/encoder identification information to the drive at power-up and it sends position feedback during operation.

Low and Medium Inertia Motors

Low inertia designs (AMK series) result in high responsiveness at high speeds for lighter loads.

- 1500W motors with 130mm flanges available

Medium inertia designs (DMK series) result in high responsiveness at moderate speeds for heavier loads.

- 1600–7500W motors available
- 130 and 180 mm flanges

FE/FF Series Motor

Motor Power Connector

4-pin watertight connector for motor power (U, V, W, and ground). For brake models, also supports brake wiring.

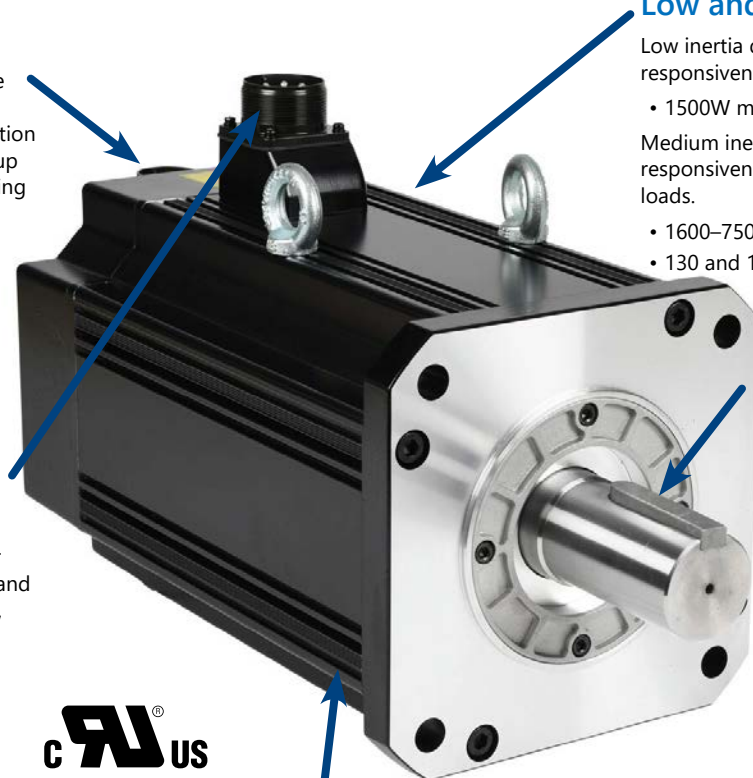

IP65 Housing

Keyed Shafts

FE and FF motors are supplied with extra-large keyways, and slightly oversized keys which may need to be "fitted" into the keyway for performance and longevity. Clamp or compression couplings (without key) are recommended.

- 900W 19mm diameter shaft
- 1500W 19mm diameter shaft
- 1600W 22mm diameter shaft
- 2200W 24mm diameter shaft
- 3500W 35mm diameter shaft
- 5500W 35mm diameter shaft
- 7500W 42mm diameter shaft

How to select and apply L7P systems

The primary purpose of the AC servo system is to precisely control the motion of the load. The most fundamental considerations in selecting the servo system are “reflected” load inertia, servo system maximum speed requirement, servo system continuous torque requirement, and servo system peak torque requirement. In a retrofit application, select the largest torque servo system that most closely matches these parameters for the system being replaced. In a new application, these parameters should be determined through calculation and/or

measurement. The Drive CM software has the ability to measure the load (reflected) inertia and accurately measure the motor torque output.

AutomationDirect has teamed with Copperhill Technologies to provide free servo-sizing software. “VisualSizer-SureServo” software will assist in determining the correct motor and drive for your application by calculating the reflected load inertia and required speed and torque based on the load configuration. “VisualSizer-SureServo” software can be downloaded from <https://support.automationdirect.com/products/lselectric.html>.

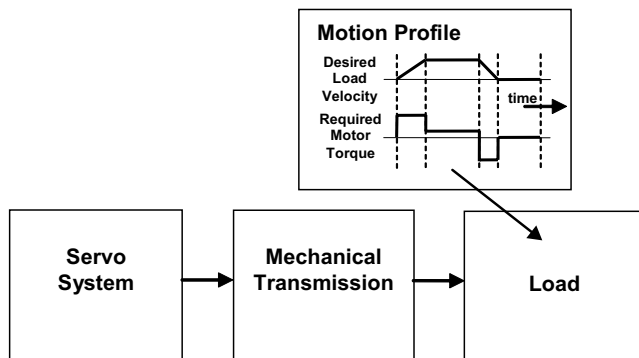

1. “Reflected” load inertia

The inertia of everything attached to the servo motor driveshaft needs to be considered and the total “reflected” inertia needs to be determined. This means that all elements of any mechanical transmission and load inertia need to be translated into an equivalent inertia as if attached directly to the motor driveshaft. The ratio of “reflected” load inertia to motor inertia needs to be carefully considered when selecting the servo system.

In general, applications that need high response or bandwidth

will benefit from keeping the ratio of load inertia to motor inertia as low as possible and ideally under 10:1. L7P Auto Tuning will still tune a system with very high response, up to 20:1 inertia mismatch. Higher system ratios can be implemented, but corresponding lower bandwidth or responsiveness must be accepted. The servo response including the attached load inertia is determined by the servo tuning. The L7P servo systems may be tuned automatically by the software/drive or manually by the user.

2. Torque and speed

With knowledge of the motion profile and any mechanical transmission between the motor and load, calculations can be made to determine the required servo motor continuous torque, peak torque, and maximum motor speed. The required amount of continuous torque must fall inside the continuous operating region of the system torque-speed curve (you can check the continuous torque at the average speed of the motion profile). The required amount of peak torque must also fall within the servo system’s intermittent operating region of the system torque-speed curve (you need to check this value at the required maximum speed or torque). If you have an L7P system, these values are easily captured and recorded with the Scope feature built into the Drive CM software. If you are designing the system from scratch, use VisualSizer to define the system and calculate expected inertia and required power.

Compare the application’s Continuous and Intermittent torque requirements to the torque-speed curves found in Chapter 16 of the L7P User Manual or in the system torque charts found on “L7P AC servo drive, motor, and cable combinations” on page tMNC-228.

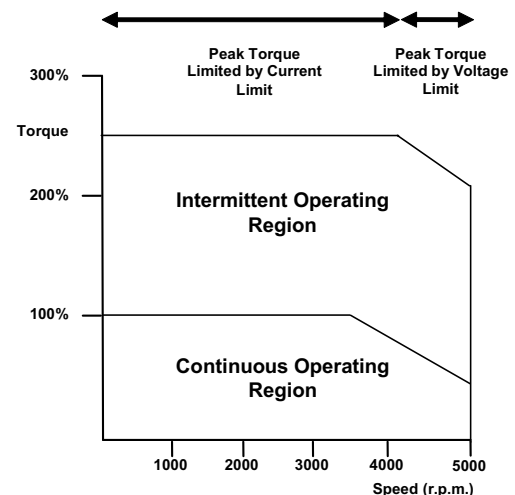

Application tip - coupling considerations

The LS Electric FBL/FCL motors have keyed shafts that can be used with keyed couplings or with clamp-on or compression style couplings. For standard keyed couplings, the servo key must be "fitted" into the keyway for optimum performance and longevity. Some minor filing and pressing of the key may be required. "Servo-grade" clamp-on or compression style couplings

are usually the best choice when you consider stiffness, torque rating, and inertia. Higher stiffness (lb-in/radian) is needed for better response but there is a trade-off between stiffness and the added inertia of the coupling. Concerning the torque rating of the coupling, use a safety factor of 1.25 over the servo's **peak** torque requirement of your application.

[Click here for Available Couplings](#)

Mechanical transmissions

Common mechanical transmissions include leadscrews, rack & pinion mechanisms, conveyors, gears, and timing belts. The use of leadscrew, rack & pinion, or conveyor are common ways to translate the rotary motion of the servo motor into linear motion of the load. Matched gearboxes are available from LS Electric that will work with the LS servo motors. Each gearbox is selected to accept the 300% maximum available torque that could be generated by the motor. Gearboxes are available in 5:1, 10:1, and 20:1 ratios. The use of a speed reducer such as a gearbox or timing belt can be very beneficial as follows:

1. Reduction of reflected load inertia

As a general rule, keep the reflected load inertia as low as possible while using the full range of servo speed. The LS Electric motors can rotate at a rated speed of 2000 or 3000 rpm (rated torque at rated speed). Their max speed (slightly less available torque) is 3000 or 5000 rpm. See the speed-torque curves for more information.

Example: A gearbox reduces the motor's required torque by a factor of the gear ratio, and reduces the reflected load inertia by a factor of the gear ratio squared. A 10:1 gearbox reduces output speed to 1/10, increases output torque 10 times, and decreases reflected inertia to 1/100.

However, when investigating the effect of different speed reduction ratios DO NOT forget to include the added inertia of couplings, gearbox, or timing belt pulleys. These added inertias can be significant, and can negate any inertia reduction due to the speed reduction.

Here is a link to our [Timing Belts and Pulleys](#)

Ordering guide instructions

The following four pages are your ordering guide for LS Electric L7P servo systems. Each system has a torque-speed curve included for reference. This is the fundamental information that you need to select the servo motor and matching drive for your application.

Each system needs:

- Motor
- Drive
- Motor Power Cable
- Motor Encoder Cable
- I/O connections (either a 50-pin CN1 cable+terminals kit or a 50-pin flying lead cable(user provides terminal blocks))
- FBL/FCL brake motors require a brake cable. FE/FF brake motors have brake wiring included in the power cable.

2. Low speed and high torque applications

If the application requires low speed and high torque then it is common to introduce a speed reducer so that the servo system can operate over more of the available speed range. This could also have the added benefit of reducing the servo motor torque requirement which could allow you to use a smaller and lower cost servo system. Additional benefits are also possible with reduction in reflected inertia, increased number of motor encoder counts at the load, and increased ability to reject load disturbances due to mechanical advantage of the speed reducer.

3. Space limitations and motor orientation

LS Electric servo motors can be mounted in any orientation, but the shaft seal should not be immersed in oil (open-frame gearbox, etc.). Reducers can possibly allow the use of a smaller motor or allow the motor to be repositioned.



Motor	Brake Motor	LS Electric MSS Planetary In-Line Gearboxes		
		5:1 Gearbox	10:1 Gearbox	20:1 Gearbox
APMC-FBL01AMK-AD	APMC-FBL01AMK2-AD			
APMC-FBL02AMK-AD	APMC-FBL02AMK2-AD	96200004	96200005	96200103
APMC-FBL04AMK-AD	APMC-FBL04AMK2-AD			
APMC-FCL08AMK-AD	APMC-FCL08AMK2-AD			
APMC-FCL10AMK-AD	APMC-FCL10AMK2-AD	96200007	96200008	96200257
APM-FEP09AMK-AD	APM-FEP09AMK2-AD			
APM-FE15AMK-AD	APM-FE15AMK2-AD	96200373	96200378	96200393
APM-FEP15AMK-AD	APM-FEP15AMK2-AD			
APM-FE16DMK-AD	APM-FE16DMK2-AD			
APM-FEP16DMK-AD	APM-FEP16DMK2-AD	96200459	96200464	96200479
APM-FE22DMK-AD	APM-FE22DMK2-AD			
APM-FEP22DMK-AD	APM-FEP22DMK2-AD	96200010	96200011	96200445
APM-FF35DMK-AD	APM-FF35DMK2-AD			
APM-FFP35DMK-AD	APM-FFP35DMK2-AD			
APM-FF55DMK-AD	APM-FF55DMK2-AD	96200013	96200014	96200701
APM-FFP55DMK-AD	APM-FFP55DMK2-AD			
APM-FF75DMK-AD	APM-FF75DMK2-AD			
APM-FFP75DMK-AD	APM-FFP75DMK2-AD	96200016	96200017	96200862 (15:1 gear ratio)

L7P series drives and motors part numbering system

Drives

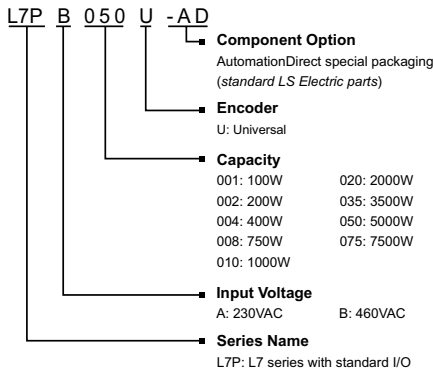

Motors

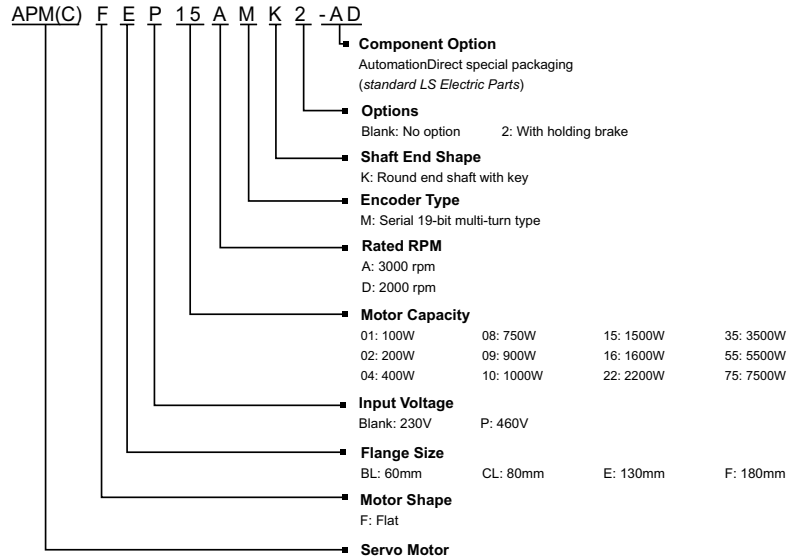

Example of what you will need to build a complete servo system:

Servo Drive

+

Servo Motor

+

Motor Power Cable

+

Motor Encoder Cable

+

I/O Interface

Completed motor assembly (with optional gearbox)

NOTE: AMPC-FBL/FCL brake equipped motors will also require a separate brake power cable.

NOTE: Unit can be programmed via keypad. Optional programming software (free download). Use a standard USB-A to USB miniB cable for connectivity (SV2-PGM-USB15, MOSAIC-CSU, or equivalent)

NOTE: If you need a gear box for your configuration, reference the gearbox chart on the previous page. Ratios of 5:1, 10:1, and 20:1 are available for each motor.





L7P Series AC Servo Systems

Torque to L7P System Quick Reference

Input Voltage	System Rated Torque (N·m)	System Maximum Torque (N·m)	Suggested Servo Motor	Required Servo Drive	
230VAC	0.32	0.96	APMC-FBL01AMK-AD	L7PA004U-AD	
			APMC-FBL01AMK2-AD		
	0.64	1.91	APMC-FBL02AMK-AD		L7PA010U-AD*
			APMC-FBL02AMK2-AD		
	1.27	3.82	APMC-FBL04AMK-AD		L7PA020U-AD
			APMC-FBL04AMK2-AD		
	2.39	7.16	APMC-FCL08AMK-AD	L7PA035U-AD	
			APMC-FCL08AMK2-AD		
	3.10	9.55	APMC-FCL10AMK-AD	L7PA050U-AD	
			APMC-FCL10AMK2-AD		
	4.77	14.32	APM-FE15AMK-AD	L7PA075U-AD	
			APM-FE15AMK2-AD		
	7.63	22.92	APM-FE16DMK-AD	L7PB010U-AD	
			APM-FE16DMK2-AD		
10.5	31.51	APM-FE22DMK-AD	L7PB020U-AD		
		APM-FE22DMK2-AD			
16.7	50.1	APM-FF35DMK-AD	L7PB035U-AD		
		APM-FF35DMK2-AD			
26.25	78.76	APM-FF55DMK-AD	L7PB050U-AD		
		APM-FF55DMK2-AD			
35.81	89.53	APM-FF75DMK-AD	L7PB075U-AD		
		APM-FF75DMK2-AD			
460VAC	2.86	8.59	APM-FEP09AMK-AD	L7PB035U-AD	
			APM-FEP09AMK2-AD		
	4.77	14.32	APM-FEP15AMK-AD	L7PB050U-AD	
			APM-FEP15AMK2-AD		
	7.64	22.92	APM-FEP16DMK-AD	L7PB075U-AD	
			APM-FEP16DMK2-AD		
	10.5	31.51	APM-FEP22DMK-AD	L7PB035U-AD	
			APM-FEP22DMK2-AD		
	16.71	50.13	APM-FFP35DMK-AD	L7PB050U-AD	
			APM-FFP35DMK2-AD		
26.26	65.65	APM-FFP55DMK-AD	L7PB075U-AD		
		APM-FFP55DMK2-AD			
35.81	89.52	APM-FFP75DMK-AD	L7PB035U-AD		
		APM-FFP75DMK2-AD			

* 1kW motors only: For single-phase supply, derate motor max torque to 200% or upsize the drive to L7PA020U-AD for max motor torque.
** 2.2 kW motors only: For single-phase supply, upsize the drive to L7PA035U-AD for max motor torque.



L7P Series AC Servo Systems

L7P AC servo drive, motor, and cable combinations

xx = Cable length in meters
 BN/EN/PN = Standard cable (not continuous flex)
 BF/EF/PF = Flex-rated cable

AMK/DMK motors = no brake
 AMK2/DMK2 motors = mechanical holding brake

230V FBL/FCL Motor Systems

Type	System Torque Chart	L7P Drive	APM/APMC Motor	Power Cable	Encoder Cable	Brake Cable	I/O Cable and Breakout
100W Low Inertia System		L7PA004U-AD	APMC-FBL01AMK-AD	APCS-PNxxLS-AD	APCS-ENxxxES1-AD	n/a	APC-VSCN1Txx-AD or APC-CN10xA-AD
				APCS-PFxxLS-AD	APCS-EFxxxES1-AD		
			APMC-FBL01AMK2-AD	APCS-PNxxLS-AD	APCS-ENxxxES1-AD	APCS-BNxxQS-AD	
				APCS-PFxxLS-AD	APCS-EFxxxES1-AD	APCS-BFxxQS-AD	
200W Low Inertia System		L7PA004U-AD	APMC-FBL02AMK-AD	APCS-PNxxLS-AD	APCS-ENxxxES1-AD	n/a	
				APCS-PFxxLS-AD	APCS-EFxxxES1-AD		
			APMC-FBL02AMK2-AD	APCS-PNxxLS-AD	APCS-ENxxxES1-AD	APCS-BNxxQS-AD	
				APCS-PFxxLS-AD	APCS-EFxxxES1-AD	APCS-BFxxQS-AD	
400W Low Inertia System		L7PA004U-AD	APMC-FBL04AMK-AD	APCS-PNxxLS-AD	APCS-ENxxxES1-AD	n/a	
				APCS-PFxxLS-AD	APCS-EFxxxES1-AD		
			APMC-FBL04AMK2-AD	APCS-PNxxLS-AD	APCS-ENxxxES1-AD	APCS-BNxxQS-AD	
				APCS-PFxxLS-AD	APCS-EFxxxES1-AD	APCS-BFxxQS-AD	
750W Low Inertia System		L7PA010U-AD	APMC-FCL08AMK-AD	APCS-PNxxLS-AD	APCS-ENxxxES1-AD	n/a	
				APCS-PFxxLS-AD	APCS-EFxxxES1-AD		
			APMC-FCL08AMK2-AD	APCS-PNxxLS-AD	APCS-ENxxxES1-AD	APCS-BNxxQS-AD	
				APCS-PFxxLS-AD	APCS-EFxxxES1-AD	APCS-BFxxQS-AD	



L7P Series AC Servo Systems

L7P AC servo drive, motor, and cable combinations, *continued*

xx = Cable length in meters

BN, EN, or PN = Standard cable (not continuous flex)

BF, EF, or PF = Flex-rated cable

AMK/DMK motors = no brake

AMK2/DMK2 motors = mechanical holding brake

Type	System Torque Chart	L7P Drive	APMC Motor	Power Cable	Encoder Cable	Brake Cable	I/O Cable and Breakout
1.0k W Low Inertia System		L7PA010U-AD	APMC-FCL10AMK-AD	APCS-PNxxxLS-AD	APCS-ENxxxES1-AD	n/a	APC-VSCN1Txx-AD or APC-CN10xA-AD
				APCS-PFxxxLS-AD	APCS-EFxxxES1-AD		
			APMC-FCL10AMK2-AD	APCS-PNxxxLS-AD	APCS-ENxxxES1-AD	APCS-BNxxQS-AD	
				APCS-PFxxxLS-AD	APCS-EFxxxES1-AD	APCS-BFxxQS-AD	

* Note - For single-phase supply, derate motor max torque to 200%, or upsize the drive to L7PA020U-AD for the torque curves in the graph.

230V FE Motor Systems

Type	System Torque Chart	L7P Drive	APM/APMC Motor	Power Cable**	Encoder Cable	I/O Cable and Breakout
1.5 kW Low Inertia System		L7PA020U-AD***	APM-FE15AMK-AD	APCS-PNxxHS-AD	APCS-ENxxxDS1-AD	APC-VSCN1Txx-AD or APC-CN10xA-AD
				APCS-PFxxHS-AD	APCS-EFxxxDS1-AD	
			APM-FE15AMK2-AD	APCS-PNxxNB-AD	APCS-ENxxxDS1-AD	
				APCS-PFxxNB-AD	APCS-EFxxxDS1-AD	
1.6 kW Medium Inertia System		L7PA020U-AD***	APM-FE16DMK-AD	APCS-PNxxHS-AD	APCS-ENxxxDS1-AD	APC-VSCN1Txx-AD or APC-CN10xA-AD
				APCS-PFxxHS-AD	APCS-EFxxxDS1-AD	
			APM-FE16DMK2-AD	APCS-PNxxNB-AD	APCS-ENxxxDS1-AD	
				APCS-PFxxNB-AD	APCS-EFxxxDS1-AD	
2.2 kW Medium Inertia System		L7PA020U-AD***	APM-FE22DMK-AD	APCS-PNxxHS-AD	APCS-ENxxxDS1-AD	APC-VSCN1Txx-AD or APC-CN10xA-AD
				APCS-PFxxHS-AD	APCS-EFxxxDS1-AD	
			APM-FE22DMK2-AD	APCS-PNxxNB-AD	APCS-ENxxxDS1-AD	
				APCS-PFxxNB-AD	APCS-EFxxxDS1-AD	

** Note - Power cables with "B" in the part number are combination power/brake cables, providing power for both the motor and the brake. A brake cable is not required.

*** Note - For single-phase supply, upsize the drive to L7PA035U-AD for the torque curves in the graph.



L7P Series AC Servo Systems

L7P AC servo drive, motor, and cable combinations, *continued*

xx = Cable length in meters
 BN, EN, or PN = Standard cable (not continuous flex)
 BF, EF, or PF = Flex-rated cable

AMK/DMK motors = no brake
 AMK2/DMK2 motors = mechanical holding brake

230V FF Motor Systems

Type	System Torque Chart	L7P Drive	APM/APMC Motor	Power Cable*	Encoder Cable	I/O Cable and Breakout
3.5 kW Medium Inertia System		L7PA035U-AD	APM-FF35DMK-AD	APCS-PNxxIS-AD	APCS-ENxxxDS1-AD	
				APCS-PFxxIS-AD	APCS-EFxxxDS1-AD	
			APM-FF35DMK2-AD	APCS-PNxxPB-AD	APCS-ENxxxDS1-AD	
				APCS-PFxxPB-AD	APCS-EFxxxDS1-AD	
5.5 kW Medium Inertia System		L7PA050U-AD	APM-FF55DMK-AD	APCS-PNxxJS-AD	APCS-ENxxxDS1-AD	APC-VSCN1Txx-AD or APC-CN10xA-AD
				APCS-PFxxJS-AD	APCS-EFxxxDS1-AD	
			APM-FF55DMK2-AD	APCS-PNxxLB-AD	APCS-ENxxxDS1-AD	
				APCS-PFxxLB-AD	APCS-EFxxxDS1-AD	
7.5 kW Medium Inertia System		L7PA075U-AD	APM-FF75DMK-AD	APCS-PNxxJS2-AD	APCS-ENxxxDS1-AD	
				APCS-PFxxJS2-AD	APCS-EFxxxDS1-AD	
			APM-FF75DMK2-AD	APCS-PNxxLB2-AD	APCS-ENxxxDS1-AD	
				APCS-PFxxLB2-AD	APCS-EFxxxDS1-AD	

*Note - Power cables with "B" in the part number are combination power/brake cables, providing power for both the motor and the brake. A brake cable is not required.



L7P Series AC Servo Systems

L7P AC servo drive, motor, and cable combinations, *continued*

xx = Cable length in meters
 BN, EN, or PN = Standard cable (not continuous flex)
 BF, EF, or PF = Flex-rated cable

AMK/DMK motors = no brake
 AMK2/DMK2 motors = mechanical holding brake

460V FEP Motor Systems

Type	System Torque Chart	L7P Drive	APM/APMC Motor	Power Cable*	Encoder Cable	I/O Cable and Breakout
1kW Low Inertia System		L7PB010U-AD	APM-FEP09AMK-AD	APCS-PNxxHS-AD	APCS-ENxxxDS1-AD	APC-VSCN1Txx-AD or APC-CN10xA-AD
				APCS-PFxxHS-AD	APCS-EFxxxDS1-AD	
			APM-FEP09AMK2-AD	APCS-PNxxNB-AD	APCS-ENxxxDS1-AD	
				APCS-PFxxNB-AD	APCS-EFxxxDS1-AD	
1.5 kW Low Inertia System		L7PB020U-AD	APM-FEP15AMK-AD	APCS-PNxxHS-AD	APCS-ENxxxDS1-AD	
				APCS-PFxxHS-AD	APCS-EFxxxDS1-AD	
			APM-FEP15AMK2-AD	APCS-PNxxNB-AD	APCS-ENxxxDS1-AD	
				APCS-PFxxNB-AD	APCS-EFxxxDS1-AD	
1.6 kW Medium Inertia System		L7PB020U-AD	APM-FEP16DMK-AD	APCS-PNxxHS-AD	APCS-ENxxxDS1-AD	
				APCS-PFxxHS-AD	APCS-EFxxxDS1-AD	
			APM-FEP16DMK2-AD	APCS-PNxxNB-AD	APCS-ENxxxDS1-AD	
				APCS-PFxxNB-AD	APCS-EFxxxDS1-AD	
2.2 kW Medium Inertia System		L7PB020U-AD	APM-FEP22DMK-AD	APCS-PNxxHS-AD	APCS-ENxxxDS1-AD	
				APCS-PFxxHS-AD	APCS-EFxxxDS1-AD	
			APM-FEP22DMK2-AD	APCS-PNxxNB-AD	APCS-ENxxxDS1-AD	
				APCS-PFxxNB-AD	APCS-EFxxxDS1-AD	

*Note - Power cables ending in "B-AD" are combination power/brake cables, and provide power for both the motor and the brake. A separate brake cable is not required.



L7P Series AC Servo Systems

L7P AC servo drive, motor, and cable combinations, *continued*

xx = Cable length in meters
 BN, EN, or PN = Standard cable (not continuous flex)
 BF, EF, or PF = Flex-rated cable

AMK/DMK motors = no brake
 AMK2/DMK2 motors = mechanical holding brake

460V FFP Motor Systems

Type	System Torque Chart	L7P Drive	APM/APMC Motor	Power Cable*	Encoder Cable	I/O Cable and Breakout
3.5 kW Medium Inertia System		L7PB035U-AD	APM-FFP35DMK-AD	APCS-PNxxIS-AD	APCS-ENxxxDS1-AD	APC-VSCN1Txx-AD or APC-CN10xA-AD
				APCS-PFxxIS-AD	APCS-EFxxxDS1-AD	
			APM-FFP35DMK2-AD	APCS-PNxxPB-AD	APCS-ENxxxDS1-AD	
				APCS-PFxxPB-AD	APCS-EFxxxDS1-AD	
5.5 kW Medium Inertia System		L7PB050U-AD	APM-FFP55DMK-AD	APCS-PFxxJS1-AD**	APCS-ENxxxDS1-AD	
				APCS-PFxxJS1-AD	APCS-EFxxxDS1-AD	
			APM-FFP55DMK2-AD	APCS-PFxxLB1-AD**	APCS-ENxxxDS1-AD	
				APCS-PFxxLB1-AD	APCS-EFxxxDS1-AD	
7.5 kW Medium Inertia System		L7PB075U-AD	APM-FFP75DMK-AD	APCS-PFxxJS1-AD**	APCS-ENxxxDS1-AD	
				APCS-PFxxJS1-AD	APCS-EFxxxDS1-AD	
			APM-FFP75DMK2-AD	APCS-PFxxLB1-AD**	APCS-ENxxxDS1-AD	
				APCS-PFxxLB1-AD	APCS-EFxxxDS1-AD	

*Note - Power cables ending in "B-AD" or "B1-AD" are combination power/brake cables, and provide power for both the motor and the brake. A separate brake cable is not required.

** - Non-flex power cable not available for some motors, use the flex cable for both flex and non-flex applications.



L7P/iX7NH AC Servo Systems

60–80 mm Frame Motor Specifications

L7P/iX7NH 60–80 mm Frame Motor Specifications										
Model	APMC-FBL01AMK-AD	APMC-FBL02AMK-AD	APMC-FBL04AMK-AD	APMC-FCL08AMK-AD	APMC-FCL10AMK-AD	APMC-FBL01AMK2-AD	APMC-FBL02AMK2-AD	APMC-FBL04AMK2-AD	APMC-FCL08AMK2-AD	APMC-FCL10AMK2-AD
Price	\$273.00	\$318.00	\$329.00	\$404.00	\$449.00	\$490.00	\$515.00	\$525.00	\$604.00	\$640.00
Drawing	PDF	PDF	PDF	PDF	PDF	PDF	PDF	PDF	PDF	PDF
Input Voltage	230VAC									
Drive Compatibility	L7P and iX7NH drives									
Integrated Brake	No					Yes				
Flange Size (mm)	60			80		60			80	
Rated Power [kW]	0.1	0.2	0.4	0.75	1	0.1	0.2	0.4	0.75	1
Rated Torque [N·m] ^{Note 1}	0.32	0.64	1.27	2.39	3.18	0.32	0.64	1.27	2.39	3.18
Max. Torque [N·m]	0.96	1.91	3.82	7.16	9.55	0.96	1.91	3.82	7.16	9.55
Rated Speed [rpm]	3000									
Max. Speed [rpm]	5000									
Mechanical Time Constant [ms]	0.926	0.518	0.374	0.609	0.492	0.926	0.518	0.374	0.609	0.492
Rated current [Amps] rms	0.95	1.45	2.6	5.02	5.83	0.95	1.45	2.6	5.02	5.83
Max. Instantaneous Current [Amps] rms	2.85	4.35	7.8	15.07	17.5	2.85	4.35	7.8	15.07	17.5
Rated Power Rate [kW/s]	11.09	27.6	27.07	45.09	62.08	11.09	27.6	27.07	45.09	62.08
Electrical Time Constant [ms]	2.416	3.488	4.271	5.774	6.919	2.416	3.488	4.271	5.774	6.919
Insulation Class	Class BE (CE, UL)									
Insulation Resistance	>10MΩ, 500VDC									
Insulation Strength	1.8 kVAC, 1 second									
Rotor Inertia [x10 ⁻⁴ kg m ²]	0.091	0.147	0.248	1.264	1.632	0.091	0.147	0.248	1.264	1.632
Allowable Load Inertia Ratio	20 times motor inertia			15 times motor inertia		20 times motor inertia			15 times motor inertia	
Max Radial Loading [N]	206			255		206			255	
Max Axial Loading [N]	69			98		69			98	
Vibration Grade [μm]	V15									
Vibration Capacity	19.6 m/s ² or lower (2.5G)									
Speed/Position Detector	Serial multi-turn built-in type (19-bit)									
Weight [kg]	0.56	0.74	1.06	2.68	3.3	1.28	1.46	1.78	3.45	4.07

Note 1—The rated torque is the continuous permissible torque between the 0°C and 40°C operating temperature which is suitable for a servo motor mounted with the following heat sink dimensions: 250mm x 250mm x 6mm made from aluminum (or mounted to equipment with an equivalent heat sinking capability).



L7P/iX7NH AC Servo Systems

130mm Frame Motor Specifications

L7P/iX7NH 130mm Frame Motor Specifications														
Model	APM-FE15AMK-AD	APM-FE16DMK-AD	APM-FE22DMK-AD	APM-FE15AMK2-AD	APM-FE16DMK2-AD	APM-FE22DMK2-AD	APM-FEP09AMK-AD	APM-FEP15AMK-AD	APM-FEP16DMK-AD	APM-FEP22DMK-AD	APM-FEP09AMK2-AD	APM-FEP15AMK2-AD	APM-FEP16DMK2-AD	APM-FEP22DMK2-AD
Price	\$644.00	\$690.00	\$745.00	\$845.00	\$893.00	\$955.00	\$590.00	\$646.00	\$698.00	\$753.00	\$793.00	\$878.00	\$930.00	\$962.00
Drawing	PDF	PDF	PDF	PDF	PDF	PDF	PDF	PDF	PDF	PDF	PDF	PDF	PDF	PDF
Input Voltage	230VAC						460VAC							
Drive Compatibility	L7P and iX7NH drives						L7P drives							
Integrated Brake	No			Yes			No				Yes			
Flange Size (mm)	130													
Rated Power [kW]	1.5	1.6	2.2	1.5	1.6	2.2	0.9	1.5	1.6	2.2	0.9	1.5	1.6	2.2
Rated Torque [N·m] <small>Note 1</small>	4.77	7.63	10.5	4.77	7.63	10.5	2.86	4.77	7.64	10.5	2.86	4.77	7.64	10.5
Max. Torque [N·m]	14.32	22.92	31.51	14.32	22.92	31.51	8.59	14.32	22.92	31.51	8.59	14.32	22.92	31.51
Rated Speed [rpm]	3000	2000		3000	2000		3000		2000		3000		2000	
Max. Speed [rpm]	5000	3000		5000	3000		5000		3000		5000		3000	
Mechanical Time Constant [ms]	1.520	1.278	1.176	1.520	1.278	1.176	2.428	1.609	1.337	1.261	2.428	1.609	1.337	1.261
Rated current [Amps] rms	9.15	10.98	12.97	9.15	10.98	12.97	3.47	6.68	4.97	6.8	3.47	6.68	4.97	6.8
Max. Instantaneous Current [Amps] rms	27.45	32.94	38.91	27.45	32.94	38.91	10.4	20.03	14.92	20.4	10.4	20.03	14.92	20.4
Rated Power Rate [kW/s]	22.38	39.89	57.9	22.38	39.89	57.9	14.5	22.4	39.92	57.95	14.5	22.4	39.92	57.95
Electrical Time Constant [ms]	9.819	10.352	11.284	9.819	10.352	11.284	7.763	9.761	10.656	10.623	7.763	9.761	10.656	10.623
Insulation Class	B													
Insulation Resistance	10MΩ													
Insulation Strength	1.8 kVAC, 1 second						2.2 kVAC, 1 second							
Rotor Inertia [x10 ⁻⁴ kg m ²]	10.18	14.62	19.43	10.18	14.62	19.43	5.659	10.179	14.619	19.04	5.659	10.179	14.619	19.04
Allowable Load Inertia Ratio	10 times motor inertia													
Max Radial Loading [N]	725													
Max Axial Loading [N]	362													
Vibration Grade [μm]	15													
Vibration Capacity	5G													
Speed/Position Detector	Serial type (19-bit)													
Weight [kg]	6.7	8.5	10.1	8.28	10.02	11.59	5.04	6.7	8.5	10.1	6.58	8.28	10.02	11.59

Note 1—The rated torque is the continuous permissible torque between the 0°C and 40°C operating temperature which is suitable for a servo motor mounted with the following heat sink dimensions: 250mm x 250mm x 6mm made from aluminum (or mounted to equipment with an equivalent heat sinking capability).



L7P/iX7NH AC Servo Systems

180mm Frame Motor Specifications

L7P/iX7NH 180mm Frame Motor Specifications												
Model	APM-FF35DMK-AD	APM-FF55DMK-AD	APM-FF75DMK-AD	APM-FF35DMK2-AD	APM-FF55DMK2-AD	APM-FF75DMK2-AD	APM-FFP35DMK-AD	APM-FFP55DMK-AD	APM-FFP75DMK-AD	APM-FFP35DMK2-AD	APM-FFP55DMK2-AD	APM-FFP75DMK2-AD
Price	\$999.00	\$1,240.00	\$1,499.00	\$1,297.00	\$1,562.00	\$1,827.00	\$1,035.00	\$1,235.00	\$1,510.00	\$1,358.00	\$1,557.00	\$1,830.00
Drawing	PDF	PDF	PDF	PDF	PDF	PDF	PDF	PDF	PDF	PDF	PDF	PDF
Input Voltage	230VAC						460VAC					
Drive Compatibility	L7P and iX7NH drives						L7P drives					
Integrated Brake	No			Yes			No			Yes		
Flange Size (mm)	180											
Rated Power [kW]	3.5	5.5	7.5	3.5	5.5	7.5	3.5	5.5	7.5	3.5	5.5	7.5
Rated Torque [N·m] ^{Note 1}	16.7	26.25	35.81	16.7	26.25	35.81	16.71	26.26	35.81	16.71	26.26	35.81
Max. Torque [N·m]	50.1	78.76	89.53	50.1	78.76	89.53	50.13	65.65	89.52	50.13	65.65	89.52
Rated Speed [rpm]	2000											
Max. Speed [rpm]	3000											
Mechanical Time Constant [ms]	1.222	0.829	0.723	1.222	0.829	0.723	1.058	0.847	0.764	1.058	0.847	0.764
Rated current [Amps] rms	16.48	28.78	32.95	16.48	28.78	32.95	9.09	14.70	18.97	9.09	14.70	18.97
Max. Instantaneous Current [Amps] rms	49.44	86.34	82.38	49.44	86.34	82.38	27.26	36.75	47.42	27.26	36.75	47.42
Rated Power Rate [kW/s]	59.89	93.27	120.15	59.89	93.27	120.15	59.98	93.38	120.15	59.98	93.38	120.15
Electrical Time Constant [ms]	15.021	19.086	20.567	15.021	19.086	20.567	14.452	23.484	20.351	14.452	23.484	20.351
Insulation Class	B											
Insulation Resistance	10MΩ											
Insulation Strength	1.8 kVAC, 1 second						2.2 kVAC, 1 second					
Rotor Inertia [x10 ⁻⁴ kg m ²]	46.56	73.85	106.7	46.56	73.85	106.7	46.56	73.85	106.73	46.56	73.85	106.73
Allowable Load Inertia Ratio	5 times motor inertia											
Max Radial Loading [N]	1548											
Max Axial Loading [N]	519											
Vibration Grade [μm]	15											
Vibration Capacity	5G											
Speed/Position Detector	Serial type (19-bit)											
Weight [kg]	17.4	25.2	34	24.6	32.4	39	17.4	25.2	34	24.6	32.4	39

Note 1—The rated torque is the continuous permissible torque between the 0°C and 40°C operating temperature which is suitable for a servo motor mounted with the following heat sink dimensions: 250mm x 250mm x 6mm made from aluminum (or mounted to equipment with an equivalent heat sinking capability).



L7P/iX7NH AC Servo Systems

Environmental Specifications

L7P/iX7NH Motor Environmental Specifications			
Model Series	APMC-FBL/FCL Motors	FE/FEP Motors	FF/FFP Motors
IP Rating	Fully closed self-cooling IP67 ¹	Fully closed self-cooling IP65 ¹	
Rated Time	Continuous		
Operating Temperature	0 to 40 °C [32 to 104 °F]		
Storage Temperature	-10 to 60 °C [14 to 140 °F]		
Operating Humidity	Below 80% RH		
Storage Humidity	Below 90% RH (non condensing)		
Atmosphere	Avoid direct sunlight and corrosive/flammable gas or liquid		
E/V	Elevation/vibration 49m/s ² (5G)		
Agency Approvals	cUR _{US} (E255738), CE		

Note 1 - Shaft connection not included. The IP rating for attached reducers/gearboxes is not guaranteed. Cables may not qualify marked IP rating if bent beyond designated specifications. Use suggested cables for maintaining IP rating.

Accessories, continued

NOTE: These parts available for sale to North American locations only

L7C/L7P/iX7NH System Motor Encoder Cables

Part Number	Price	Flex Rated	Length	Gauge	Drawing	Compatible Motors
APCS-EN03ES-AD	\$48.00	N	3m [9.8 ft]	24AWG	PDF	APMC motors with 17-bit incremental encoders (AYK/AYK2 motors)
APCS-EN05ES-AD	\$58.00		5m [16.4 ft]		PDF	
APCS-EN10ES-AD	\$67.00		10m [32.8 ft]		PDF	
APCS-EN20ES-AD	\$79.00		20m [65.6 ft]		PDF	
APCS-EF03ES-AD	\$70.00	Y	3m [9.8 ft]		PDF	
APCS-EF05ES-AD	\$83.00		5m [16.4 ft]		PDF	
APCS-EF10ES-AD	\$116.00		10m [32.8 ft]		PDF	
APCS-EF20ES-AD	\$188.00		20m [65.6 ft]		PDF	
APCS-EN03ES1-AD	\$79.00	N	3m [9.8 ft]	24AWG	PDF	FBL/FCL series motors with 19-bit encoders
APCS-EN05ES1-AD	\$83.00		5m [16.4 ft]		PDF	
APCS-EN10ES1-AD	\$96.00		10m [32.8 ft]		PDF	
APCS-EN20ES1-AD	\$120.00		20m [65.6 ft]		PDF	
APCS-EF03ES1-AD	\$99.00	Y	3m [9.8 ft]		PDF	
APCS-EF05ES1-AD	\$117.00		5m [16.4 ft]		PDF	
APCS-EF10ES1-AD	\$159.00		10m [32.8 ft]		PDF	
APCS-EF20ES1-AD	\$244.00		20m [65.6 ft]		PDF	
APCS-EN03DS1-AD	\$83.00	N	3m [9.8 ft]	24AWG	PDF	APM-FE/APM-FF series motors
APCS-EN05DS1-AD	\$88.00		5m [16.4 ft]		PDF	
APCS-EN10DS1-AD	\$99.00		10m [32.8 ft]		PDF	
APCS-EN20DS1-AD	\$123.00		20m [65.6 ft]		PDF	
APCS-EF03DS1-AD	\$104.00	Y	3m [9.8 ft]		PDF	
APCS-EF05DS1-AD	\$120.00		5m [16.4 ft]		PDF	
APCS-EF10DS1-AD	\$159.00		10m [32.8 ft]		PDF	
APCS-EF20DS1-AD	\$246.00		20m [65.6 ft]		PDF	



APCS-EN series encoder cable



APCS-ENxxxES1 series encoder cable



APC-EF00BS-AD

L7P/iX7NH System Encoder Accessories

Part Number	Price	Description	Compatible Drives
APC-EF00BS-AD	\$20.00	17-pin motor encoder connector.	APM-FE and APM-FF series motors
APCS-BATT36-AD	\$36.00	Encoder battery. One (1) AA ER6V lithium battery with extended leads and an encoder cable connector.	All LS Electric motors with 19-bit encoders



APCS-BATT36-AD

Accessories, *continued*

NOTE: These parts available for sale to North American locations only

L7C/L7P/iX7NH System Motor Brake Power Cables

Part Number	Price	Flex Rated	Length	Gauge	Drawing	Compatible Motors
<u>APCS-BN03QS-AD</u>	\$52.00	N	3m [9.8 ft]	18AWG	<u>PDF</u>	APMC FBL/FCL brake motors (100W – 1kW)
<u>APCS-BN05QS-AD</u>	\$55.00		5m [16.4 ft]		<u>PDF</u>	
<u>APCS-BN10QS-AD</u>	\$61.00		10m [32.8 ft]		<u>PDF</u>	
<u>APCS-BN20QS-AD</u>	\$74.00		20m [65.6 ft]		<u>PDF</u>	
<u>APCS-BF03QS-AD</u>	\$58.00	Y	3m [9.8 ft]		<u>PDF</u>	
<u>APCS-BF05QS-AD</u>	\$63.00		5m [16.4 ft]		<u>PDF</u>	
<u>APCS-BF10QS-AD</u>	\$79.00		10m [32.8 ft]		<u>PDF</u>	
<u>APCS-BF20QS-AD</u>	\$108.00		20m [65.6 ft]		<u>PDF</u>	



APCS-BN series brake cable

L7P System Non-Brake Motor Power Cables

Part Number	Price	Flex Rated	Length	Gauge	Drawing	Compatible Motors
APCS-PN03LS-AD	\$42.00	N	3m [9.8 ft]	18AWG	PDF	FBL/FCL series motors
APCS-PN05LS-AD	\$46.00		5m [16.4 ft]		PDF	
APCS-PN10LS-AD	\$57.00		10m [32.8 ft]		PDF	
APCS-PN20LS-AD	\$80.00		20m [65.6 ft]		PDF	
APCS-PF03LS-AD	\$53.00	Y	3m [9.8 ft]		PDF	
APCS-PF05LS-AD	\$62.00		5m [16.4 ft]		PDF	
APCS-PF10LS-AD	\$90.00		10m [32.8 ft]		PDF	
APCS-PF20LS-AD	\$145.00		20m [65.6 ft]		PDF	
APCS-PN03HS-AD	\$45.00	N	3m [9.8 ft]	14AWG	PDF	APM-FE series motors without brake
APCS-PN05HS-AD	\$54.00		5m [16.4 ft]		PDF	
APCS-PN10HS-AD	\$76.00		10m [32.8 ft]		PDF	
APCS-PN20HS-AD	\$119.00		20m [65.6 ft]		PDF	
APCS-PF03HS-AD	\$62.00	Y	3m [9.8 ft]		PDF	
APCS-PF05HS-AD	\$80.00		5m [16.4 ft]		PDF	
APCS-PF10HS-AD	\$127.00		10m [32.8 ft]		PDF	
APCS-PF20HS-AD	\$222.00		20m [65.6 ft]		PDF	
APCS-PN03IS-AD	\$61.00	N	3m [9.8 ft]	14AWG	PDF	230VAC APM-FF35D and 460VAC APM-FFP35D motors without brakes
APCS-PN05IS-AD	\$77.00		5m [16.4 ft]		PDF	
APCS-PN10IS-AD	\$119.00		10m [32.8 ft]		PDF	
APCS-PN20IS-AD	\$199.00		20m [65.6 ft]		PDF	
APCS-PF03IS-AD	\$77.00	Y	3m [9.8 ft]		PDF	
APCS-PF05IS-AD	\$103.00		5m [16.4 ft]		PDF	
APCS-PF10IS-AD	\$169.00		10m [32.8 ft]		PDF	
APCS-PF20IS-AD	\$305.00		20m [65.6 ft]		PDF	
APCS-PN03JS-AD	\$68.00	N	3m [9.8 ft]	10AWG	PDF	230VAC APM-FF55D motors without brake
APCS-PN05JS-AD	\$90.00		5m [16.4 ft]		PDF	
APCS-PN10JS-AD	\$139.00		10m [32.8 ft]		PDF	
APCS-PN20JS-AD	\$258.00		20m [65.6 ft]		PDF	
APCS-PF03JS-AD	\$97.00	Y	3m [9.8 ft]		PDF	
APCS-PF05JS-AD	\$137.00		5m [16.4 ft]		PDF	
APCS-PF10JS-AD	\$237.00		10m [32.8 ft]		PDF	
APCS-PF20JS-AD	\$440.00		20m [65.6 ft]		PDF	
APCS-PF03JS1-AD	\$82.00	Y	3m [9.8 ft]	12AWG	PDF	460VAC APM-FFP55D and APM-FFP75D motors without brakes
APCS-PF05JS1-AD	\$111.00		5m [16.4 ft]		PDF	
APCS-PF10JS1-AD	\$186.00		10m [32.8 ft]		PDF	
APCS-PF20JS1-AD	\$339.00		20m [65.6 ft]		PDF	
APCS-PN03JS2-AD	\$117.00	N	3m [9.8 ft]	8AWG	PDF	230VAC APM-FF75D motors without brake
APCS-PN05JS2-AD	\$163.00		5m [16.4 ft]		PDF	
APCS-PN10JS2-AD	\$276.00		10m [32.8 ft]		PDF	
APCS-PN20JS2-AD	\$499.00		20m [65.6 ft]		PDF	
APCS-PF03JS2-AD	\$169.00	Y	3m [9.8 ft]		PDF	
APCS-PF05JS2-AD	\$247.00		5m [16.4 ft]		PDF	
APCS-PF10JS2-AD	\$439.00		10m [32.8 ft]		PDF	
APCS-PF20JS2-AD	\$824.00		20m [65.6 ft]		PDF	

NOTE: These parts available for sale to North American locations only



APCS-PxxLS series power cable



APCS-PxxHS series power cable



APCS-PxxIS series power cable



APCS-PxxJS series power cable

Accessories, continued

L7P System Brake Motor Power Cables

Part Number	Price	Flex Rated	Length	Gauge	Drawing	Compatible Motors			
<p>Note: For FBL/FCL 100W-1kW motors with brake, use the power cables on page tMNC-234 (APCS-PxxxLS-AD) AND separate brake cable APCS-BxxxQS-AD from page tMNC-232. This is for FBL/FCL motors only. FE and FF motors have brake wiring incorporated into the power cable (below).</p>									
APCS-PN03NB-AD	\$49.00	N	3m [9.8 ft]	14AWG	PDF	230VAC and 460 VAC APM-FE series motors with brakes			
APCS-PN05NB-AD	\$58.00		5m [16.4 ft]		PDF				
APCS-PN10NB-AD	\$84.00		10m [32.8 ft]		PDF				
APCS-PN20NB-AD	\$137.00		20m [65.6 ft]		PDF				
APCS-PF03NB-AD	\$71.00	Y	3m [9.8 ft]		PDF				
APCS-PF05NB-AD	\$95.00		5m [16.4 ft]		PDF				
APCS-PF10NB-AD	\$153.00		10m [32.8 ft]		PDF				
APCS-PF20NB-AD	\$274.00		20m [65.6 ft]		PDF				
APCS-PN03PB-AD	\$69.00	N	3m [9.8 ft]		PDF	230VAC APM-FF35D and 460VAC APM-FFP35D motors with brakes			
APCS-PN05PB-AD	\$87.00		5m [16.4 ft]		PDF				
APCS-PN10PB-AD	\$133.00		10m [32.8 ft]		PDF				
APCS-PN20PB-AD	\$229.00		20m [65.6 ft]		PDF				
APCS-PF03PB-AD	\$88.00	Y	3m [9.8 ft]		PDF				
APCS-PF05PB-AD	\$120.00		5m [16.4 ft]		PDF				
APCS-PF10PB-AD	\$198.00		10m [32.8 ft]		PDF				
APCS-PF20PB-AD	\$359.00		20m [65.6 ft]		PDF				
APCS-PN03LB-AD	\$77.00	N	3m [9.8 ft]	8AWG	PDF	230VAC APM-FF55D motors with brake			
APCS-PN05LB-AD	\$99.00		5m [16.4 ft]		PDF				
APCS-PN10LB-AD	\$153.00		10m [32.8 ft]		PDF				
APCS-PN20LB-AD	\$265.00		20m [65.6 ft]		PDF				
APCS-PF03LB-AD	\$114.00	Y	3m [9.8 ft]		PDF				
APCS-PF05LB-AD	\$160.00		5m [16.4 ft]		PDF				
APCS-PF10LB-AD	\$275.00		10m [32.8 ft]		PDF				
APCS-PF20LB-AD	\$510.00		20m [65.6 ft]		PDF				
APCS-PF03LB1-AD	\$95.00	Y	3m [9.8 ft]		12AWG	PDF	460VAC APM-FFP55D and APM-FFP75D motors with brakes		
APCS-PF05LB1-AD	\$130.00		5m [16.4 ft]			PDF			
APCS-PF10LB1-AD	\$220.00		10m [32.8 ft]			PDF			
APCS-PF20LB1-AD	\$400.00		20m [65.6 ft]			PDF			
APCS-PN03LB2-AD	\$130.00	N	3m [9.8 ft]			8AWG		PDF	230VAC APM-FF75D motors with brake
APCS-PN05LB2-AD	\$177.00		5m [16.4 ft]					PDF	
APCS-PN10LB2-AD	\$300.00		10m [32.8 ft]					PDF	
APCS-PN20LB2-AD	\$540.00		20m [65.6 ft]					PDF	
APCS-PF03LB2-AD	\$187.00	Y	3m [9.8 ft]	PDF					
APCS-PF05LB2-AD	\$272.00		5m [16.4 ft]	PDF					
APCS-PF10LB2-AD	\$479.00		10m [32.8 ft]	PDF					
APCS-PF20LB2-AD	\$906.00		20m [65.6 ft]	PDF					



APCS-PxxNB series power cable



APCS-PxxPB series power cable



APCS-PxxLB series power cable

Accessories, continued





LS Drive System Replacement Connectors

Part Number	Price	Description	Compatible Drives	Image
<u>5452573</u>	\$6.50	AutomationDirect replacement drive power connector.	All L7C drives	
<u>APC-CN1NNA-AD</u>	\$17.50	LS solder-type CN1 50-pin Electric I/O connector.	All L7C and L7P series drives	
<u>APC-CN2NNA-AD</u>	\$15.00	LS Electric I/O connector, replacement, 20-pin.	All iX7NH series drives	
<u>APC-CN3NNA-AD</u>	\$17.50	LS Electric solder-type CN2 14-pin drive encoder connector.	All L7C, L7P, and iX7NH series drives	
<u>APCS-CN6K-AD</u>	\$19.00	LS Electric STO connector, replacement, 6-pin. For use with all LS Electric iX7 series drives.	All iX7NH series drives	
<u>IX7-CON-A</u>	\$19.00	AutomationDirect drive power connector, replacement, 11-pin. Note: Do not wire to pin 4 (the "N" terminal).	iX7NH series drives, 400W, 750W, and 1kW	
<u>IX7-CON-B</u>	\$19.00	AutomationDirect drive power connector for motor power, replacement, 4-pin.	iX7NH series drives, 400W, 750W, and 1kW	
<u>IX7-CON-C</u>	\$9.00	AutomationDirect drive power connector release, replacement.	iX7NH series drives, 400W, 750W, and 1kW	
<u>IX7-CON-D</u>	\$19.00	AutomationDirect drive power connector for motor power, replacement, 4-pin	iX7NH series drives, 2kW and 3.5 kW	
<u>IX7-CON-E</u>	\$19.00	AutomationDirect drive control power connector, replacement, 5-pin.	iX7NH series drives, 2kW and 3.5 kW	
<u>IX7-CON-F</u>	\$19.00	AutomationDirect drive main power connector, replacement, 6-pin.	iX7NH series drives, 2kW and 3.5 kW	
<u>L7P-CON-A</u>	\$15.00	Replacement 11-pin drive power connector. Do not wire to pin 4 (the "N" terminal)	L7PA series 230VAC 400W and 1kW drives	
<u>L7P-CON-B</u>	\$8.00	Replacement 3-pin drive power connector.	L7PA series 230VAC 400W and 1kW drives	

Continued on next page

Accessories, *continued*

LS Drive System Replacement Connectors, *continued*

Part Number	Price	Description	Compatible Drives	Image
<u>L7P-CON-C</u>	\$20.00	Replacement 11-pin drive power connector.	L7PB series 460VAC 1kW drives, all L7P series 2kW and 3.5 kW drives	
<u>L7P-CON-D</u>	\$7.50	Replacement 3-pin drive power connector.	L7PB series 460VAC 1kW drives, all L7P series 2kW and 3.5 kW drives	
<u>L7P-CON-E</u>	\$0.50	Drive analog monitor crimp pins (24-48 AWG), package of 5.	All L7P and iX7NH drives. Requires L7P-CON-F	
<u>L7P-CON-F</u>	\$2.00	Drive analog monitor 4-pin crimp connector.	All L7P and iX7NH drives. Requires L7P-CON-E	
<u>L7P-CON-G</u>	\$2.00	Drive analog monitor 4-pin IDC connector (26AWG).	All L7P and iX7NH series drives	

Accessories, continued

L7C/L7P/iX7NH System Braking Resistors

Use external braking resistors to provide additional regenerative capacity and to dissipate heat away from the servo drive.

Part Number	Price	Description	Drawing	Compatible Drive Series	Compatible Drive Models
<u>APCS-140R50-AD</u>	\$18.50	LS Electric 140W 30Ω encapsulated braking resistor	<u>PDF</u>	All 400W LS drives	L7CA004U-AD L7PA004U-AD IX7NHA004U-AD
<u>APCS-300R30-AD</u>	\$24.00	LS Electric 300W 30Ω encapsulated braking resistor	<u>PDF</u>	All 230VAC 750W and 1kW LS drives	L7CA010U-AD L7PA010U-AD IX7NHA008U-AD IX7NHA010U-AD
<u>APC-600R30-AD</u>	\$42.00	LS Electric 600W 30Ω encapsulated braking resistor.	<u>PDF</u>	All 230VAC 2.2 kW and 3.5 kW LS drives	L7PA020U-AD L7PA035U-AD IX7NHA020U-AD IX7NHA035U-AD
<u>APC-600R28-AD</u>	\$64.00	LS Electric 600W 28Ω encapsulated braking resistor.	<u>PDF</u>	All 230VAC 5.5 kW and 7.5 kW LS drives	L7PA050U-AD L7PA075U-AD
<u>APCS-300R82-AD</u>	\$16.00	LS Electric 300W 82Ω encapsulated braking resistor.	<u>PDF</u>	All 460VAC 1kW LS drives	L7PB010U-AD
<u>APCS-600R140-AD</u>	\$42.00	LS Electric 600W 140Ω encapsulated braking resistor.	<u>PDF</u>	Alternate resistor for 460VAC 2.2 kW and 3.5 kW LS drives	Alternate resistor for L7PB020U-AD L7PB035U-AD
<u>APCS-600R75-AD</u>	\$42.00	LS Electric 600W 75Ω encapsulated braking resistor.	<u>PDF</u>	All 460VAC 2.2, 3.5, 5.5, and 7.5 kW LS drives	L7PB020U-AD L7PB035U-AD L7PB050U-AD L7PB075U-AD



NOTE: 600W resistors require customer-supplied M5-.8 bolts and cable lugs for connection.



APCS-140R50-AD

Accessories, continued

NOTE: These parts available for sale to North American locations only

L7C/L7P/iX7NH/PHOX System Planetary Gearboxes

Precision planetary gearboxes can increase the torque output of servo systems while reducing the reflected load inertia for higher response. Gearboxes offer high stiffness, high efficiency, and very quiet operation. Input motor shaft clamp, oversized output shaft key, and mounting hardware are included for mating to LS Electric motors.

Features:

- Maintenance free (no need to replace lubrication)
- IP65
- Operating temperature range of -10°C to +90°C [14°F to 194°F]
- Uses VIGO Grease RE #0



MSS Series Planetary Gearbox

MSS Series Planetary Gearbox Specifications										
Model	96200004	96200005	96200103	96200007	96200008	96200257	96200373	96200378	96200393	96200459
Manufacturer Part Number	MSS0601A-005KS-B3110103C14	MSS0601A-010KS-B3110103C14	MSS0902B-020KS-B3110103C14	MSS0901A-005KS-C3110103C19	MSS0901A-010KS-C3110103C19	MSS1152B-020KS-C4120103C19	MSS0901A-005KS-C4120103C19	MSS0901A-010KS-C4120103C19	MSS1152B-020KS-C4120103C19	MSS1151A-005KS-D3110103C22
Compatible Motors	APMC-FBL series 100, 200, 300, and 400 W motors			APMC FCL series 750W and 1kW motors			APM-FE series 900W and 1.5 kW motors			APM-FE series 1.6 kW motors
Price	\$288.00	\$296.00	\$528.00	\$387.00	\$387.00	\$762.00	\$350.00	\$350.00	\$699.00	\$499.00
Drawing	PDF	PDF	PDF	PDF	PDF	PDF	PDF	PDF	PDF	PDF
Ratio	5:1	10:1	20:1	5:1	10:1	20:1	5:1	10:1	20:1	5:1
Nominal Output Torque	54 N·m	42 N·m	143 N·m	160 N·m	121 N·m	295 N·m	160 N·m	121 N·m	295 N·m	332 N·m
Inertia	0.13 kg/cm ²	0.13 kg/cm ²	0.13 kg/cm ²	0.48 kg/cm ²	0.44 kg/cm ²	0.48 kg/cm ²	0.48 kg/cm ²	0.44 kg/cm ²	0.48 kg/cm ²	2.81 kg/cm ²
Output Shaft Diameter	16mm	16mm	22mm	22mm	22mm	32mm	22mm	22mm	32mm	32mm
Stage	1	1	2	1	1	2	1	1	2	1
Frame	60mm	60mm	90mm	90mm	90mm	115mm	90mm	90mm	115mm	115mm
Nominal Input Speed (rpm)	5,000	5,000	4,000	4,000	4,000	4,000	4,000	4,000	4,000	4,000
Max Input Speed (rpm)	10,000	10,000	8,000	8,000	8,000	8,000	8,000	8,000	8,000	8,000
Emergency Stop Torque	3 times nominal output torque									
Noise (dB)	≤54	≤54	≤56	≤56	≤56	≤59	≤56	≤56	≤59	≤59
Efficiency (%)	≥97	≥97	≥94	≥97	≥97	≥94	≥97	≥97	≥94	≥97
Backlash (Arcmin)	≤7	≤7	≤9	≤7	≤7	≤9	≤7	≤7	≤9	≤7
Max Radial Load (N)	1,280	1,280	3,200	3,200	3,200	6,800	3,200	3,200	6,800	6,800
Max Axial Load (N)	690	690	1,600	1,600	1,600	3,400	1,600	1,600	3,400	3,400
Service Life (Hours)	20,000 (10,000 under continuous operation)									
Continued on next page										



LS Electric AC Servo Systems

Accessories, continued

MSS Series Planetary Gearbox Specifications											
Model	96200464	96200479	96200010	96200011	96200445	96200013	96200014	96200701	96200016	96200017	96200862
Manufacturer Part Number	MSS1151A-010KS-D3110103C22	MSS1422B-020KS-D3110103C22	MSS1151A-005KS-D3110103C24	MSS1151A-010KS-D3110103C24	MSS1422B-020KS-D3110103C24	MSS1421A-005KS-E3110103C35	MSS1421A-010KS-E3110103C35	MSS1802B-020KS-E3110103C35	MSS1801A-005KS-F3110103C42	MSS1801A-010KS-F3110103C42	MSS1802A-015KS-F3110103C42
Compatible Motors	APM-FE series 1.6 kW motors		APM-FE series 2.2 kW motors			APM-FF series 3.5 kW and 5.5 kW motors			APM-FF series 7.5 kW motors		
Price	\$499.00	\$1,030.00	\$499.00	\$499.00	\$1,030.00	\$770.00	\$770.00	\$1,850.00	\$1,480.00	\$1,480.00	\$1,850.00
Drawing	PDF	PDF	PDF	PDF	PDF	PDF	PDF	PDF	PDF	PDF	PDF
Ratio	10:1	20:1	5:1	10:1	20:1	5:1	10:1	20:1	5:1	10:1	15:1
Nominal Output Torque	262 N·m	295 N·m	332 N·m	262 N·m	295 N·m	634 N·m	500 N·m	1060 N·m	1195 N·m	960 N·m	897 N·m
Inertia	2.59 kg/cm ²	2.81 kg/cm ²	2.81 kg/cm ²	2.59 kg/cm ²	2.81 kg/cm ²	7.52 kg/cm ²	7.05 kg/cm ²	7.52 kg/cm ²	24.29 kg/cm ²	23.51 kg/cm ²	24.29 kg/cm ²
Output Shaft Diameter	32mm	40mm	32mm	32mm	40mm	40mm	40mm	55mm	55mm	55mm	55mm
Stage	1	2	1	1	2	1	1	2	1	1	2
Frame	115mm	142mm	115mm	115mm	142mm	142mm	142mm	180mm	180mm	180mm	180mm
Nominal Input Speed (rpm)	4,000	3,000	4,000	4,000	3,000	3,000	3,000	3,000	3,000	3,000	3,000
Max Input Speed (rpm)	8,000	6,000	8,000	8,000	6,000	6,000	6,000	6,000	6,000	6,000	6,000
Emergency Stop Torque	3 times nominal output torque										
Noise (dB)	≤59	≤62	≤59	≤59	≤62	≤62	≤62	≤64	≤64	≤64	≤64
Efficiency (%)	≥97	≥94	≥97	≥97	≥94	≥97	≥97	≥94	≥97	≥97	≥94
Backlash (Arcmin)	≤7	≤9	≤7	≤7	≤9	≤7	≤7	≤9	≤7	≤7	≤9
Max Radial Load (N)	6,800	9,300	6,800	6,800	9,300	9,300	9,300	15,100	15,100	15,100	15,100
Max Axial Load (N)	3,400	4,500	3,400	3,400	4,500	4,500	4,500	7,500	7,500	7,500	7,500
Service Life (Hours)	20,000 (10,000 under continuous operation)										